

**GOVERNMENT OF INDIA**  
**Ministry of Rural Development**

**Study on the Environmental and Social Aspects of  
PRADHAN MANTRI GRAM SADAK YOJANA**

**FINAL REPORT**  
**Environmental Codes of Practice**



**LEA Associates South Asia Pvt. Ltd.**

July 21, 2004

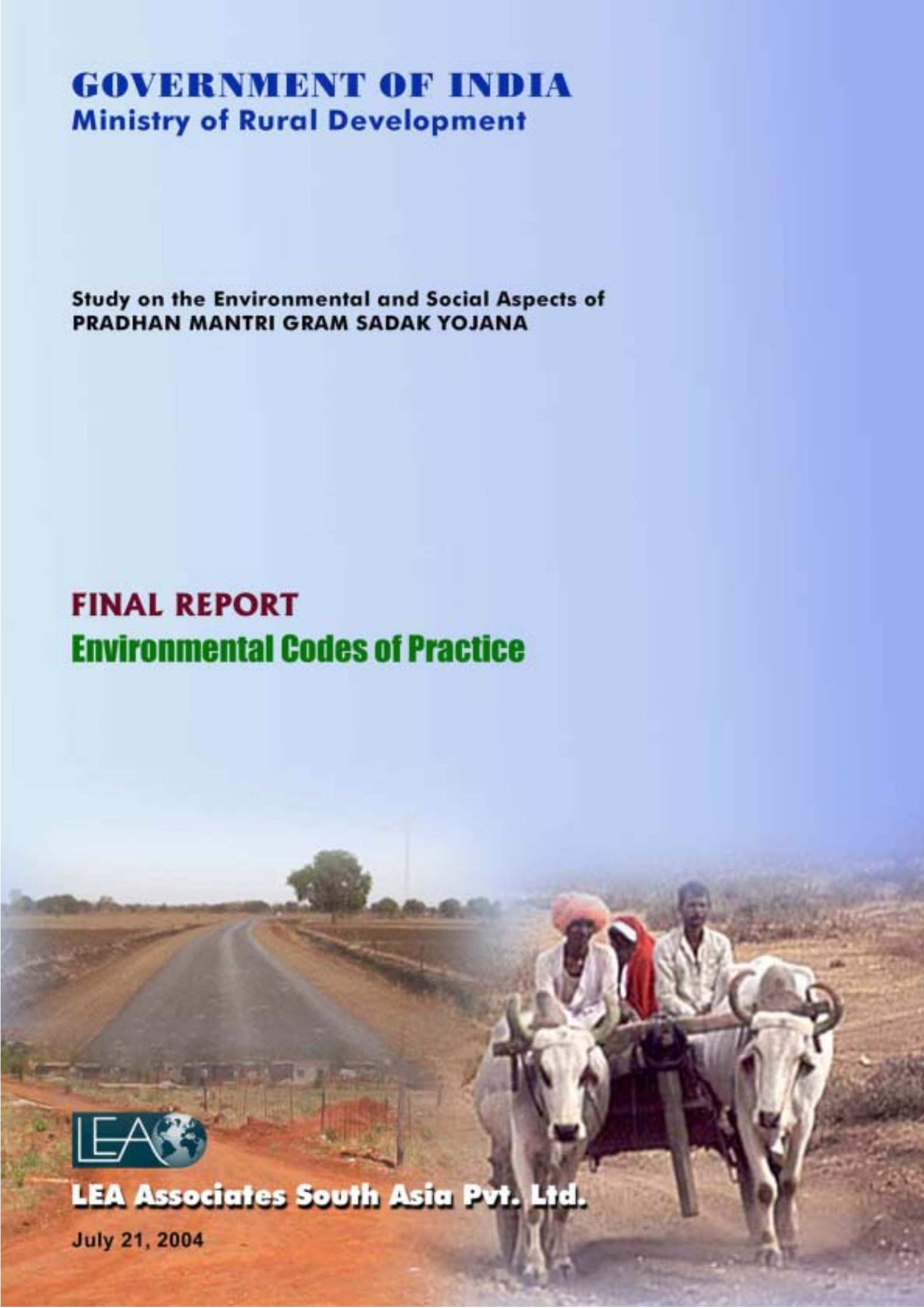







# Table of Contents

---

TABLE OF CONTENTS.....	II
LIST OF ANNEXURES.....	III
ABBREVIATIONS .....	IV
INTRODUCTION .....	IV
ECOP-1.0 PROJECT PLANNING & DESIGN .....	1-1
ECOP-2.0 SITE PREPARATION.....	2-1
ECOP-3.0 CONSTRUCTION CAMPS .....	3-1
ECOP-4.0 ALTERNATE MATERIALS FOR CONSTRUCTION.....	4-1
ECOP-5.0 BORROW AREAS.....	5-1
ECOP-6.0 TOPSOIL SALVAGE, STORAGE AND REPLACEMENT .....	6-1
ECOP-7.0 QUARRY MANAGEMENT.....	7-1
ECOP-8.0 WATER FOR CONSTRUCTION.....	8-1
ECOP-9.0 SLOPE STABILITY AND EROSION CONTROL.....	9-1
ECOP-10.0 WASTE MANAGEMENT.....	10-1
ECOP-11.0 WATER BODIES.....	11-1
ECOP-12.0 DRAINAGE.....	12-1
ECOP-13.0 CONSTRUCTION PLANTS & EQUIPMENT MANAGEMENT .....	13-1
ECOP-14.0 PUBLIC AND WORKER’S HEALTH AND SAFETY .....	14-1
ECOP-15.0 CULTURAL PROPERTIES.....	15-1
ECOP-16.0 TREE PLANTATION .....	16-1
ECOP-17.0 MANAGING INDUCED DEVELOPMENT .....	17-1
ECOP-18.0 ENVIRONMENTAL AUDIT .....	18-1
ECOP-19.0 NATURAL HABITATS.....	19-1
ECOP-20.0 CONSULTATIONS FOR ENVIRONMENTAL ASPECTS .....	20-1
REFERENCES .....	V

## List of Annexures

---

ANNEXURE 1-1:	SCREENING OF SUB-PROJECTS
ANNEXURE 3-1:	SAMPLE LAYOUT OF CONSTRUCTION CAMP
ANNEXURE 4-1:	MOU FOR PROCURING QUARRY OVERBURDEN
ANNEXURE 5-1:	CERTIFICATE FOR COMPLETION OF RECLAMATION
ANNEXURE 8-1:	LETTER OF CONSENT FOR USAGE OF WATER FOR CONSTRUCTION
ANNEXURE 10-1:	NO OBJECTION CERTIFICATE FOR TEMPORARY USAGE OF LAND
ANNEXURE 11-1:	DRAWING AND BOQ FOR WATER BODY PROTECTION
ANNEXURE 15-1:	DRAWING AND BOQ FOR RELOCATION OF CULTURAL PROPERTY
ANNEXURE 16-1:	MOU BETWEEN PRI, PIU AND FOREST DEPARTMENT
ANNEXURE 20-1:	INFORMATION BROCHURE
ANNEXURE 20-2:	METHODOLOGY FOR TRANSECT WALK
ANNEXURE 20-3:	FORMAT FOR RECORDING CONSULTATION

## Abbreviations

---

AAV	Aggregate Abrasion Value
BoQ	Bill of Quantities
CD Structures	Cross Drainage Structures
CPCB	Central Pollution Control Board
DPR	Detailed Project Report
ECoP	Environmental Code of Practice
GP	Gram Panchayat
GS	Gram Sabha
GSB	Granular Sub- Grade
HFL	High Flood Level
IRC	Indian Roads Congress
IS	Indian Standards
MoEF	Ministry of Environment and Forest
MoRD	The Ministry of Rural Development
MoRT&H	Ministry of Road Transport and Highways
MoU	Memorandum of Understanding
NOC	No-Objection Certificate
NQM	National Quality Monitor
O & M	Operation and Maintenance
ODR	Other District Roads
OM	Operations Manual
PIU	Programme Implementation Units
PMGSY	Pradhan Mantri Gram Sadak Yojana
PRIs	Panchayat Raj Institutions
PSV	Polished Stone Value
PUC	Pollution Under Control
PWD	Public Works Department
RoW	Right of Way
S W Plains	South West Plains
SP	Special Publications
SPCB	State Pollution Control Board
WBM	Water Bound Macadam



# Introduction

---

Rural Connectivity and growth are linked intrinsically, be it in the area of Trade, Employment, Education or Healthcare. Rural road connectivity is a key component of rural development in securing poverty alleviation by providing easy access to marketing centers for the agricultural produce at lower transportation cost resulting in higher price realisation thereby increasing rural income. The roads further promote access to education, healthcare, increased employment opportunities, improve economic activities and generally result in higher standard of living. Against the above background of inadequate rural road connectivity, the Prime Minister announced in 2000 the Pradhan Mantri Gram Sadak Yojana (PMGSY), a program to address this backlog of connecting the 3,30,000 unconnected habitations.

## PMGSY Targets...

- €# Achieving all-weather road access to every village/habitation with a population greater than 1000 by 2003; and
- €# Providing all-weather road access to all villages/habitations of greater than 500 people [250 in case of hill states (North-East, Sikkim, Himachal Pradesh, Jammu & Kashmir and Uttaranchal) and the desert areas (as identified in the Desert Development Programme)] by the end of the Tenth Five Year Plan, i.e., 2007.

The Ministry of Rural Development (MoRD) administers the program as a centrally sponsored scheme in all the States and six Union Territories. The MoRD has identified executing agencies in each of the states. These agencies have worked out mechanisms for implementation through setting up of Programme Implementation Units (PIU) in each of the districts.

## 1. Need for Environmental Codes of Practice

The Indian Roads Congress (IRC) publication, IRC:SP:20-2002, Rural Roads Manual (RRM), provides guidance on various aspects of rural road development, with the specific requirements of PMGSY. Further to this, to bring about clarity on various aspects of the programme, leading to its timely and successful implementation, an Operations Manual (OM) in respect of PMGSY roads has been prepared. Rural road improvements such as the PMGSY have the potential to bring in substantial economic and social benefits to the communities. At the same time, these projects may also lead to adverse social and environmental impacts such as loss of topsoil, erosion etc, thereby triggering the need to develop Environmental Codes of Practice (ECoP).

## Scope of the Environmental Codes of Practice ...

To form a field guide/manual to the planners, field engineers and contractors to:

- €# **Identify** the project activities that can have potential environmental impacts and to provide mitigation measures
- €# **Demonstrate** the road design and construction practices, that are cost-effective and address environmental impacts
- €# **Illustrate** the recommended practices to address the environmental concerns during project planning, implementation and operation
- €# **Define** the role of involvement of the rural communities at different stages of the project, and,
- €# **Achieve** the PMGSY objectives of rural connectivity through roads planned and constructed to blend with the natural surroundings.

## 2. Utility of Codes of Practice

These codes of practice have been developed to guide the planning, design, construction and maintenance stages of PMGSY in terms of avoidance or mitigation of the adverse environmental impacts that may result from the projects. The codes define methods and procedures to be followed by the Executing Agencies, Contractors and other agencies involved in the project, in the states of Rajasthan, Uttar Pradesh, Himachal Pradesh and Jharkhand.



# ECoP-1.0 Project Planning & Design

## 1.1 General

1.1.1 This code of practice details the factors to be considered during project preparation to avoid/address environmental concerns through modifications in project design and incorporation of mitigation measures. Guidelines specified in the IRC:SP-20:2002 for project preparation are to be followed in conjunction with the measures suggested as part of this ECoP.

## 1.2 Finalisation of Alignment

1.2.1 All requirements of Section 1.5 of IRC: SP-20: 2002 in selection of alignment should be met with. In addition, adequate consultations with the communities to identify the concerns and preferences need to be taken up during selection of the alignment. Rural roads being low volume roads shall be aligned to follow the natural topography. Finalisation of alignment shall be carried out in accordance with the provisions presented below.

The alignment should be...
≠ Short
≠ Easy and safe to construct and maintain
≠ Economical
≠ Laid on firm ground
≠ Aesthetic and
≠ Having least adverse environmental impacts.

1.2.2 Alignment shall conform to the natural topography as far as possible to avoid excessive cut and fill. In case of hill areas the alignment selection should extend to incorporate the provisions of IRC:SP-48:1998, "Hill Road Manual".

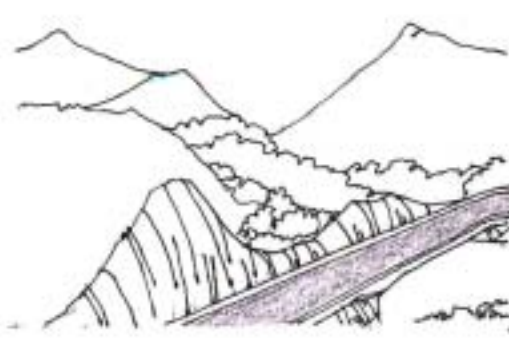
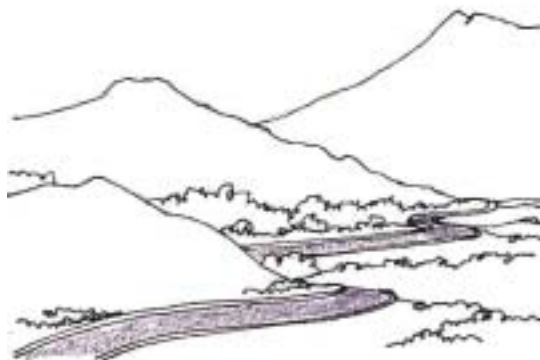
High Impact Road	Low Impact Road
	
<p><b>High standard roads</b></p> <ul style="list-style-type: none"> <li>≠ Good geometrics</li> <li>≠ Moves large volume of traffic rapidly and safely.</li> <li>≠ Huge cuts and fills, stability of slopes</li> <li>≠ Damage to vegetation, and</li> <li>≠ Disruption to natural drainage patterns</li> </ul>	<p><b>Low standard roads</b></p> <ul style="list-style-type: none"> <li>≠ Conforms to the natural topography</li> <li>≠ Suitable for low volume rural roads and low travel speeds</li> <li>≠ Reduced environmental impacts                             <ul style="list-style-type: none"> <li>○ Reduces the cut and fill,</li> <li>○ Reduces damage to vegetation</li> <li>○ Minimise changes to natural drainage patterns.</li> </ul> </li> </ul>

1.2.3 An inventory of all environmental features along the proposed road is to be prepared and marked on a revenue map. This would be conducted by the PIU in co-ordination with the local community and the revenue officials through transects. Consultations with the local communities are to be conducted during these transects to obtain their suggestions and incorporate their concerns to address the potential environmental impacts. Suggestions of the community during the transect walk are to be incorporated, to the extent possible, while finalising the alignment.

The methodology for conduct of transect shall be as per ECoP-20.0, “Consultations for Environmental Aspects”.

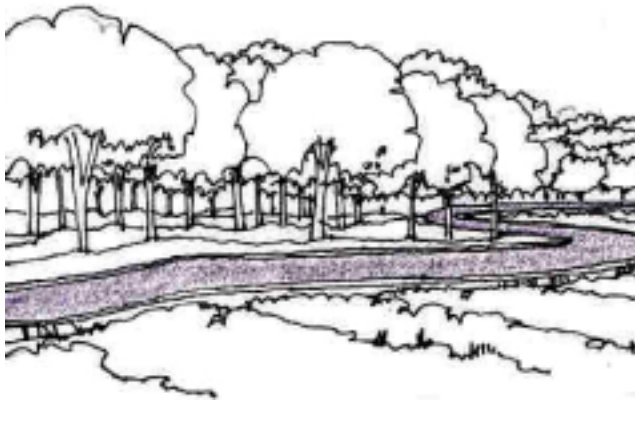
<p><b>Inventorize the following ...</b></p>	
<ul style="list-style-type: none"> <li># Trees</li> <li># Forests if any</li> <li># Drainage lines, rivers and water crossings</li> <li># Irrigation water courses</li> <li># Water bodies</li> <li># Grazing lands</li> <li># Cultural properties</li> <li># Utilities</li> <li># Community facilities</li> <li># Schools</li> <li># Hospitals</li> <li># Major junctions</li> <li># Seasonal markets or cultural congregations</li> <li># Location for Ramps, Cattle Crossing and Bus Bay</li> <li># Location for stacking maintenance material</li> <li># Location for ducts for threading agricultural pipes</li> </ul>	

1.2.4 In case of flood prone areas and/or areas with very flat slopes, hydrological surveys have to be conducted before alignment finalisation. Inputs derived from these surveys such as the need for provision of culverts/bridges or other cross/roadside drainage structures should be considered in the alignment finalisation. Routes involving higher costs on drainage compared to alternative routes should be avoided. In case of hill areas, geological studies have to be conducted to determine locations of loose rock, soil or potential sites for land slides.

### 1.3 Design considerations

1.3.1 All the road designs should conform to the specifications of IRC:SP-20:2002, “Rural Roads Manual”. Additional measures suggested for minimisation of environmental impacts, safety of road users and for enhancement of community benefits are indicated in this ECoP. Where it is necessary to deviate from the IRC specifications, the following design considerations shall be the absolute minimum.

<p><b>Recommended Practices for Alignment Finalisation...</b></p>
<ul style="list-style-type: none"> <li># Utilise existing revenue tracts as far as possible</li> <li># Follow natural topography</li> <li># Conform alignment to within property boundaries within village areas</li> <li># Adopt geometrics that do not compromise on safety requirements</li> <li># Avoid crossing power transmission lines, water mains, gas lines etc</li> <li># Avoid alignments affecting vegetation and felling of trees</li> <li># Avoid alignments close to streams</li> <li># Avoid encroachment of water bodies and</li> <li># Avoid passing through natural habitats as designated forests, sanctuaries, national parks and wetlands</li> </ul>

1.3.2 **Design Speed:** Ruling design speed may be **reduced to 40 km/hr from 50 km/hr in plain and 35 km/hr in rolling terrain**. This speed is to be followed in link roads less than 10km length without any further relaxation.

1.3.3 **Road Land Width:** If larger widths are available the existing standards of IRC:SP-20:2002 should be followed. The minimum standard road land width may be reduced to 12 m in plains in areas where it is difficult to obtain 15 m, keeping local conditions in view and after assigning reasons of keeping reduced width. The requirement may be further reduced to 9 m in areas under intensive irrigation and where traffic is less than 100 vehicles/day. But in such cases, the roadway width shall also be reduced to 6 m. The road land width in hilly areas shall be such as to achieve a roadway width of 6m..

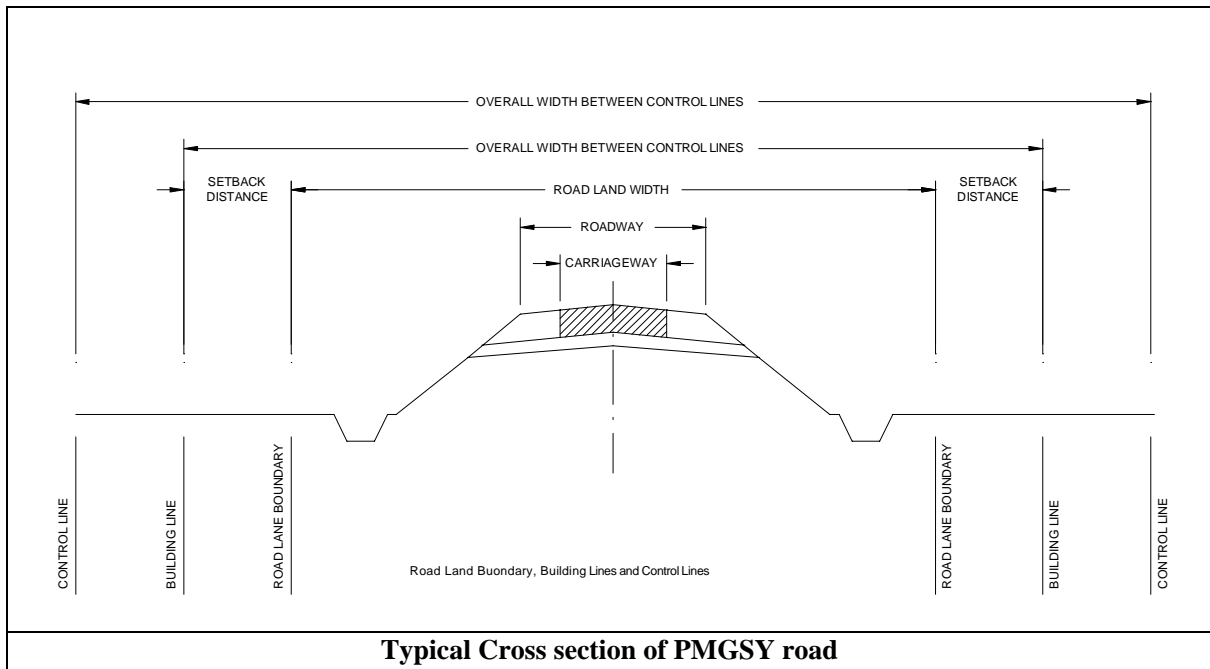

1.3.4 **Roadway Width (Formation width):** The minimum of 7.5 m of roadway may be reduced to 6 m in case of hilly terrain<sup>1</sup> and short link village roads connecting single habitations. This would result in reducing the need of larger road land width and reduce quantity of soil required for embankments. A minimum of 9 m of formation / roadway width shall be adopted for cutting section in deserts areas to avoid roadblocks normally caused by dune sand accumulation where reduced width is provided.

Alignment selection criteria in hill roads ...	
<ul style="list-style-type: none"> <li>⚡# <b>The road should cross the ridges at their lowest elevation.</b> Relative economics are to be worked out before deciding upon the alignment.</li> <li>⚡# <b>Hairpin bends are to be kept to a minimum.</b> If unavoidable the alignment should be such that a flat hill slope is obtained for its location.</li> <li>⚡# <b>Unstable hill slopes to be avoided,</b> as such slopes are prone to landslides and are subject to seepage or flow from streams.</li> <li>⚡# <b>Avoid encroaching on wetlands or water bodies.</b></li> <li>⚡# Provide adequate cross-drainage structures to ensure that natural drainage patterns are not altered</li> </ul>	

1.3.5 **Carriageway Width:** Standard carriageway width of 3.75 m is to be adopted on all roads. It may be however be reduced to 3.0 m in exceptional cases such as hilly terrain or as per provisions of IRC: SP-20: 2002. Hard shoulders of 1 m width may be provided on either side only in case longer routes or “through” village roads connecting many habitations to cater for the expected increase in traffic intensity

Low embankment height reduces...
<ul style="list-style-type: none"> <li>⚡# Quantity of earth work</li> <li>⚡# Redevelopment costs of borrow areas</li> <li>⚡# Dune sand accumulation in desert areas and</li> <li>⚡# Requirement of land for construction of road</li> </ul>

1.3.6 **Embankment height:** Lower embankment height of 0.3 – 0.4m to be provided in case of arid and sandy areas. In case of desert areas, the embankment height could be reduced since no overtopping is anticipated. In flood prone areas, height of embankment shall not be reduced and shall be a minimum of 0.6m above expected highest water level.

1.3.7 **Geometrics:** (i) The alignment should be designed for maximum possible radius of curves. Minimum absolute curve radius of 50m @ 40 km/hr and 38m @ 35 km/hr should be adopted without further relaxation due to safety reasons. (ii) Junction design of access road with collector road should be in conformity with IRC: SP-20: 2002 for both sight distance and flaring requirements.

<sup>1</sup> In the stretches where obligatory to obtain a road land width of only 6m due to reasons of land availability, minimum roadway width of 5.2m shall be provided for the roads under first year projects.

1.3.8 **Drainage:** For large catchment areas with low ground slopes, the accumulation of water causes flooding on the up-stream of the road. The increased velocity of water passing through the culverts causes scour on the down-stream and alters natural ground levels and scour of land. Hydrological studies are to be conducted in large catchment areas to limit the afflux and provide adequate waterway for cross-drainage structures.

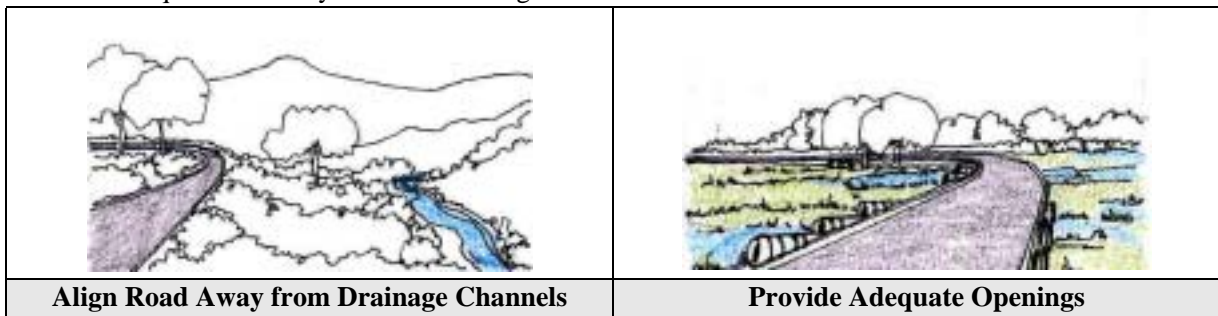

1.3.9 **Built up areas:** It should be ensured that the road level in built up areas is lower than the plinth of the adjoining houses and drains are provided to drain the storm water.

1.3.10 **Enhancements:**

- i. Cattle crossings to be provided at normal crossing routes for safety of both cattle and road user.
- ii. Ramps for access to and from agriculture lands for cross traffic are to be provided to avoid damage to embankment and roadside drain.
- iii. At all CD works shall have steps constructed for inspection, repair and maintenance purpose.
- iv. Shoulders should be paved at destination/roadside villages and provide bus bays to avoid traffic obstruction and to provide for turning radius wherever feasible.
- v. Where possible, the embankment should be widened to provide a platform for stacking material for maintenance and to ensure that the shoulders are kept free for movement of traffic.
- vi. Where ever required 300mm ducts should be provided to enable cultivators to thread agricultural pipes for irrigating their fields lying on either side of the proposed road.

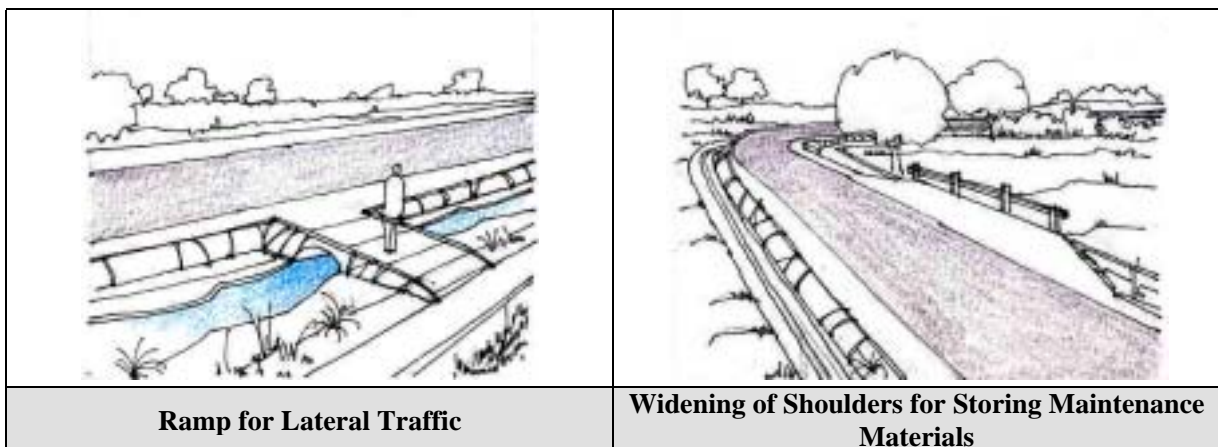

1.3.11 **Community Concerns:** Community concerns, expressed during consultations are to be addressed to the extent possible in the design of the road. The concerns need to be documented and checked for addressal. In case any of the measures are not incorporated, the same needs to be intimated to the community with adequate explanation after design finalisation.

1.3.12 **Road Signages:** Adequate informatory, cautionary and warning road signs should be provided to ensure traffic safety, especially in the event of adoption of lower standards. The signboards should be placed such that they do not block the line of sight.

## 1.4 Environmental considerations

1.4.1 Environmental considerations for various activities and sub-activities in the project are presented in the **Table 1-4**. Measures for the same are to be incorporated in the project preparation stage to offset environmental impacts in the subsequent stages (**Table 1-3**). The measures shall be in conformance with the ECoP referred against the activities.

1.4.2 Corridors prioritized as per the core network shall be subjected to screening<sup>2</sup> as per the screening checklist (**Annexure 1-1**). The roads so screened as per the checklist shall be subjected to greater analysis in the DPR for the issue/s due to which it is screened.

1.4.3 Environmental concerns of the community shall be incorporated to the extent possible in the project preparation and in the subsequent stages of the project. This is achieved through various consultation tools by PIU or Contractor as per the **Table 1-1**.

Key environmental concerns to be mitigated...	
⚡	Land, including loss of productive topsoil
⚡	Drainage
⚡	Land use and livelihood
⚡	Vegetation, cutting of trees
⚡	Forests, wild life, fisheries and aquatic habitat
⚡	Water bodies and water quality
⚡	Slope stability
⚡	Wetlands
⚡	Structures and
⚡	Common property resources

**Table 1-1: Consultations to be conducted in various stages of the project**

Sl.No.	Stage/Activities	Responsible Agencies	Stakeholders	Tools & Techniques	Desired Outputs	Reference
<b>1</b>	<b>Project Prioritisation</b>					
1.1	Dissemination of Core network	PIU	Community / PRI	Display of list of villages and length of corridor maps at gram panchayat	⚡ Increasing awareness of community about PMGSY ⚡ Transparency in selection of roads	Resettlement Framework
<b>2</b>	<b>Project Preparation</b>					
2.1	Dissemination of project information	PIU	Community	Distribution of Project Information Brochure	⚡ Sensitisation of communities ⚡ Increasing awareness of community about roles and responsibilities	Resettlement Framework
2.2	Finalisation of Alignment	PIU	Community / PRI	Transect Walk	⚡ Inventory of environmental features, identification of sites for voluntary donation, identification of PAPs	ECoP-1
2.3	Formal Consultations with PAPs	PIU	Community	Focus group discussions, public meetings	⚡ Disseminate information on environmental concerns incorporated/not incorporated into design	Annexure 20 -2
<b>3</b>	<b>Implementation Stage</b>					
3.1	Consultations for temporary use of land	Contractor	Community / land owner	Individual consultations	⚡ Seeking consent on temporary use of land and setting terms of use	ECoP-3.0 ECoP-5.0 ECoP-6.0 ECoP-10.0 ECoP-13.0 ECoP-14.0
3.2	Consultations for extraction of water	Contractor	Community / Well owner	Individual consultation	⚡ Seeking consent on extraction of water <sup>3</sup>	ECoP-8.0
3.3	Consultations for relocation	PIU	Community / PRI	Consultation	⚡ Area for relocation of utilities and cultural properties	ECoP-2.0 ECoP-15.0
3.4	Consultation for tree plantation	PIU	Community / PRI	Consultation	⚡ Identification of persons for tree plantation ⚡ Location for plantation	ECoP-16.0
3.5	Consultation for avoiding induced development	PIU	Community / PRI	Consultation	⚡ Sensitising PRI on effects of Induced development ⚡ Identification of locations for avoiding/promoting induced development on community land	ECoP-17.0

<sup>2</sup> Screening of the corridor would not be a deterrent towards its selection for implementation. The screening process is intended to facilitate identification of scope for analysis in the DPR stage.

<sup>3</sup> For the ease of the Executing Agency, consents under 3.1 and 3.2 may be obtained together after combining the respective formats for consents.

1.4.4 Towards implementation of the environmental provisions by the contractor as per the ECoPs, he shall nominate one of his senior personnel to ensure that the construction practices comply with the ECoPs.

## 1.5 Compliance to legal requirements

1.5.1 The clearance requirements as per the various legislations in force towards the conservation of the environment during the various project stages, as applicable to the project are presented in **Table 1-2**.

**Table 1-2: Environmental Clearance Requirements - PMGSY**

Project Stage	Activity requiring clearance	State (s)				Agency from whom clearance to be sought	Legislative requirement	Responsibility
		R	H	U	J			
Pre-construction	Road Projects in Himalayas & Forest Areas					Ministry of Env. State office	Environmental Clearance, Jan. 1992	PIU
	Diversion of Forest Land					State forest department	Forest Conservation Act 1980	PIU
	Alignment through Sensitive Areas					Forest department, Irrigation department	Transfer of Land Forest (Conservation) Act 1980, Forest (Conservation) Rule 1980	PIU
	Water for Construction					GWB, Irrigation department	Control on Setting up of Tube Wells	Contractor
	Wild Life Protection					Wild Life Department	Wild life Protection Act	PIU
	Quarry Area Plan					Mining Department	Mining Act, India Explosives Act	Contractor
Construction	Setting up and O&M of Hot Mix Plants					State Pollution Control Board	Air (Prevention and Control of Pollution) Act 1981 Municipal Solid Waste Management Rules, 2000 & Hazardous waste management & handling rules, 2000	Contractor
	Noise from construction					State Pollution Control Board	Environment Protection Rules 1986	Contractor
	Blasting operation					Indian Explosives Mining Department	Indian Explosive 1884	Contractor
	Operation of equipment and machinery					Road Transport Office, Pollution Control Board	Motor Vehicles Act, Emission norms and standards	Contractor
	Labour laws					Department of Labour	Minimum Wages Act	Contractor
	Quarry area materials extraction					Mining department	Mining act, Indian explosives act 1880	Contractor

*Legend: R = Rajasthan, H = Himachal Pradesh, U = Uttar Pradesh, J = Jharkhand*

1.5.2 The bid document shall include the various applicable clearances pertaining to environmental management and shall contain the necessary procedures for compliance of the same.

1.5.3 The site for construction shall be handed over to the contractor, free from encumbrances and encroachments. Forest clearances, if required shall be obtained prior to start of the project and utilities shall be relocated before handing over the site.

## 1.6 Integrating Environmental Provisions in bid documents

1.6.1 The design and environmental considerations discussed above have to be incorporated suitably in the DPR and the bid document to ensure implementation. Towards this end, the following steps should be taken by the PIU:

1.6.1.1 Detailed Drawings if any for the environmental provisions as per the environmental codes of practice, as required, are to be included in the DPR viz., ECoP-1.0 (Project Planning & Design) Widening of CW for bus stops and bus-

### Construction scheduling – factors to consider...

- # Overall scheduling to incorporate climatic factors, snow fall, harsh weather conditions
- # Agricultural practices and harvesting seasons
- # Timing of specific activities to avoid special weather conditions
- # Events of importance in the project area as festive seasons etc
- # Availability of local labour during harvest seasons

bays, widening at junctions, ECoP-3.0, Construction Camp, ECoP-11.0, Water bodies and ECoP-15.0, Cultural Properties.. The drawings are to include specifications of the materials used and also the detailed bill of quantities in the bid document.

1.6.1.2 Cost implications of environmental measures suggested by the environmental codes of practice have to be included in the estimates for the project.

1.6.1.3 Monitoring arrangements towards the implementation of the environmental provisions are to be specified. The reporting formats are provided as per the **ECoP-18.0**, “Environment Audit”.

1.6.1.4 As per clause 26 of the Standard Bidding Document of MoRD, the contractor is expected to submit for approval of the engineer, the general methods, arrangements, orders and timing for all the activities in the works along with monthly cash flow. In scheduling the construction works, it is expected that the contractor considers all the risks and schedule the activities, which are likely to be impacted by weather phenomenon in a period in which these phenomenon are unlikely to occur. This would also need review and final approval of the engineer. In view of the above approval, the milestones indicated at Para 19 of “Contract Data to General Conditions of Contract”, to be achieved during the contract period may be suitably amended.

**Timing of activities-factors to consider...**

- ## If there is a time lag (more than a fortnight) between WBM and black-topping, the surface needs to be suitably blinded and may have to be rerolled as per the instructions of the Engineer of the PIU.
- ## The time lag between the prime coat and the final black-topping shall be minimum and in any event be not more than 3 days.
- ## Sealed coat shall immediately follow the 20mm carpet on the same day.

1.6.2 The environmental concerns to be addressed in the preparation of DPR are detailed out in the **Table 1-3** and **Table 1-4**.

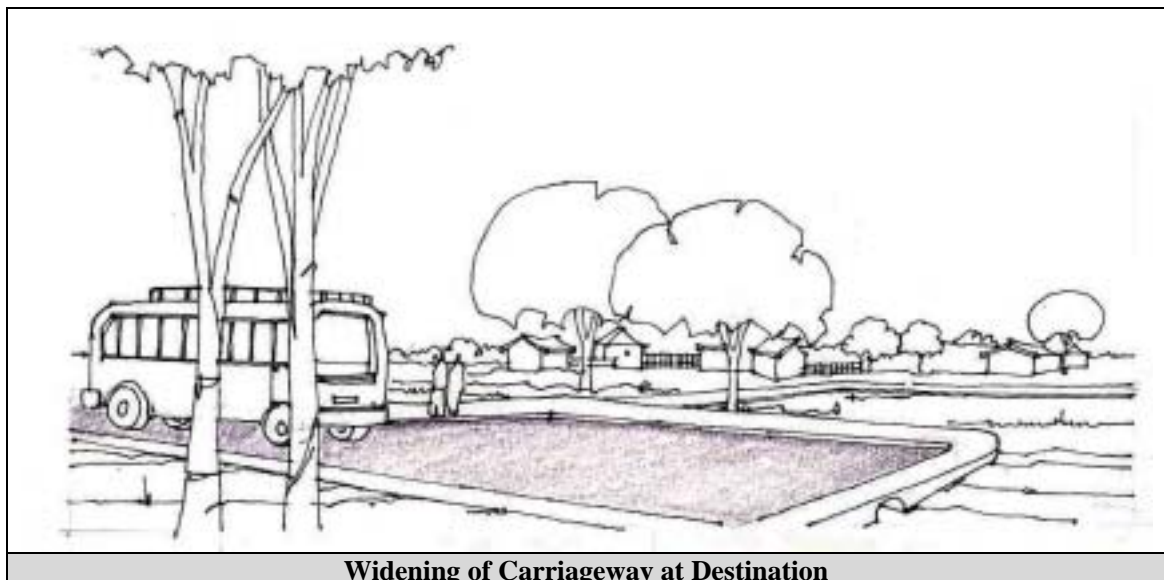

**Widening of Carriageway at Destination**

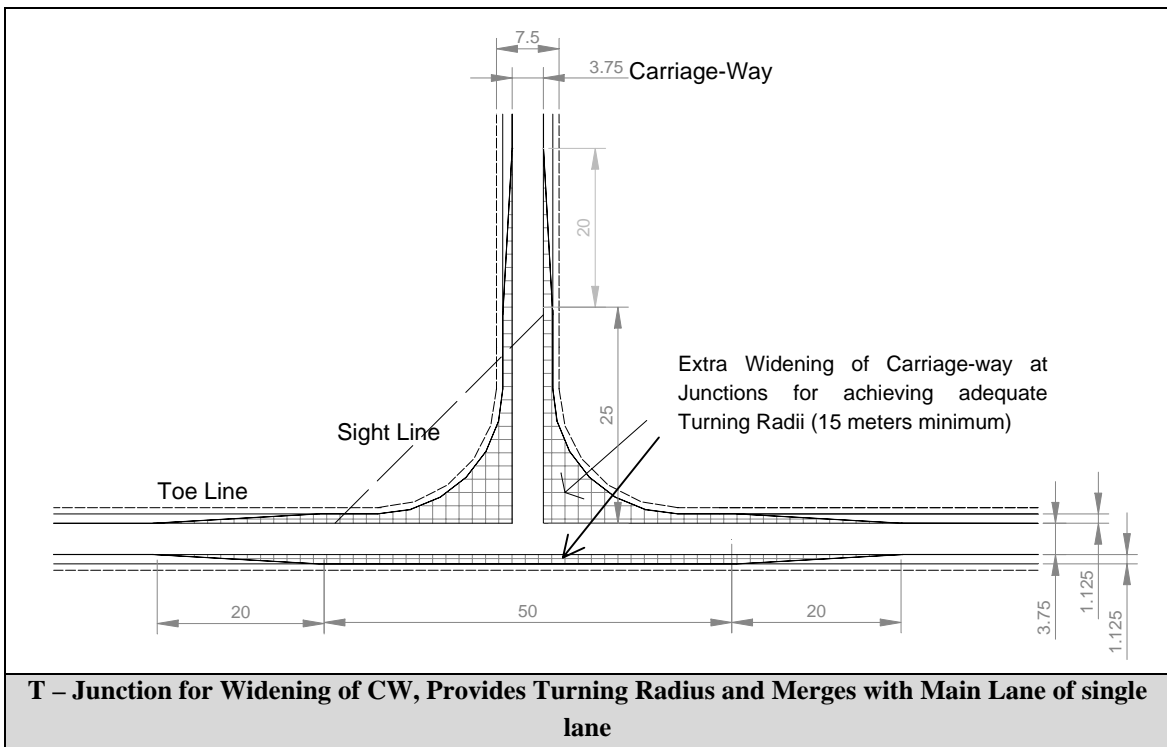
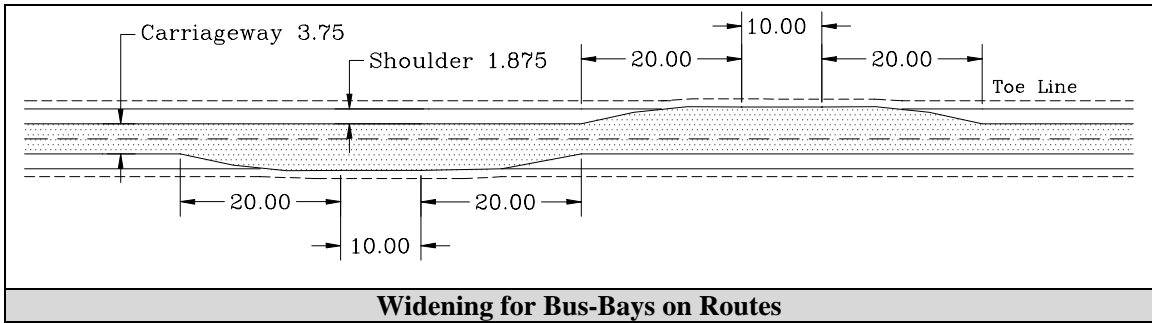
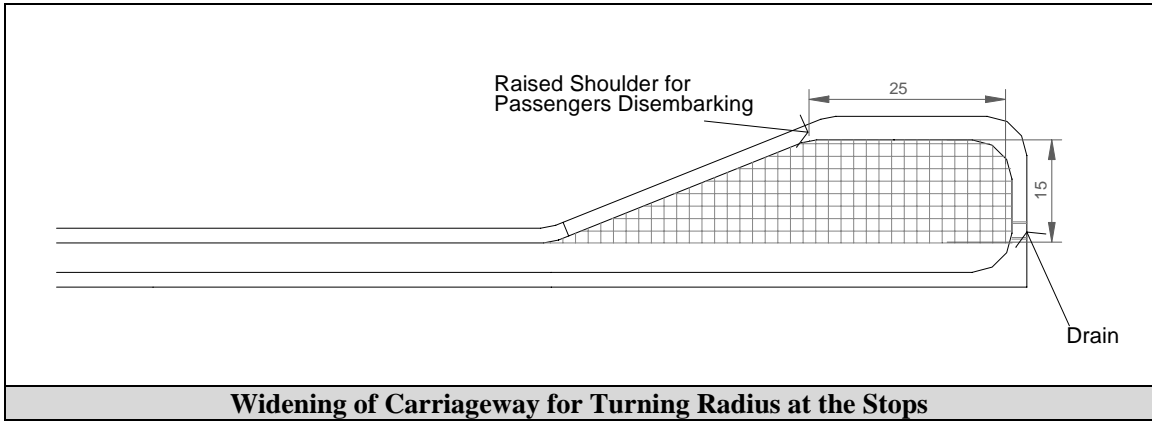

**Table 1-3: Environmental concerns in DPR preparation**

Sl.No.	Activity	Items to consider	Measures to address	Detailed in
1.0	Transact Walk	Trees	Inventorisation of environmental features Avoidance, design modifications to minimize adverse environmental impacts Incorporating community concerns into finalizing alignment	ECoP 1.0
		Forests		
		Drainage lines / Rivers / water crossings		
		Irrigation water courses		
		Water bodies		
		Grazing lands		
		Cultural properties		
		Utilities		
		Community facilities		
		Major junctions		
		Seasonal markets or cultural congregations		
		Location for Ramps, Cattle Crossing and Bus Bay		
		Location for stacking maintenance material		
Location for ducts for threading agricultural pipes				
2.0	Detailed Surveys	Geological, geotechnical studies in hill areas	Stability analysis and measures to address slope instability in hill slopes and high banks	ECoP 1.0
		Topographical surveys	Working out requirement of cut and fill	
		Hydrological surveys in flood prone areas	Identification of flood prone areas and measures to avoid afflux Identification of agricultural use of land	
3.0	Identification of material sources	Borrow material	Utilizing alternative materials	ECoP 4.0
			Minimize requirements through design modifications	ECoP 5.0
			Location criteria	ECoP 4.0
		Quarry material	Utilizing alternative materials	ECoP 4.0
			Material extraction from existing quarries	ECoP 7.0
		Water availability	Identification of perennial/community/private sources	ECoP 8.0
Scheduling construction to suit water availability	Utilizing community water sources without conflict of uses			
4.0	Assessment of environmental impacts	Climatic factors	Scheduling construction considering the special weather phenomena	ECoP 1.0
		Water bodies	Provision of silt fencing	ECoP 11.0
			Rehabilitation of water bodies	ECoP 20.0
		Stability of slopes	Measures for slope stabilization	ECoP 9.0
		Soil erosion	Erosion control measures	ECoP 9.0
		Land use changes	Land use control measures adjacent to the road	ECoP 17.0
			Empowering Gram Panchayat / Road Authority to regulate development	
		Agriculture lands	Avoidance from setting up construction camps, borrow areas	ECoP 3.0, ECoP 5.0 ECoP 6.0
			Conservation of top soil	
			Site restoration after construction	
		Cultural properties	Avoidance through design modifications Planning for Relocation & rehabilitation	ECoP 15.0
		Common Property Resources	Avoidance through design modification Planning for Relocation of consultation with community	ECoP 1.0
		Drainage	Provision of adequate number of CD Structures	ECoP 12.0
		Trees	Compensatory plantation & arrangements for roadside plantation	ECoP 16.0
Forest areas	Avoidance through design modifications	ECoP 16.0 ECoP 19.0		
	Environment Management measures during construction	ECoP 13.0		
Natural Habitats	Avoidance through design modification or formulating additional measures for avoiding impacts	ECoP 19.0		
5.0	Precautionary measures during construction to avoid environmental impacts	Top soil	Stockpile topsoil and preservation	ECoP 6.0
		Construction sites	Provision of pollution control measures	ECoP 13.0
			All measures to ensure public & worker's health/safety	ECoP 14.0
			Water Management	ECoP 10.0
		Construction camps	Criteria for identification of sites and Infrastructure arrangements	ECoP 3.0
			Safe disposal of all wastes	ECoP 10.0
			Enforcement of pollution control measures	ECoP 13.0
		Borrow areas	Arrangements with land owners to include redevelopment	ECoP 5.0
		Quarry areas	Rehabilitation of quarry areas if new quarries are opened	ECoP 7.0
Public/workers health & safety	Personal Protective Equipment to be provided	ECoP 14.0		
	Public safety at construction sites to be undertaken			
Measures for worker's health & hygiene at construction camps	ECoP 3.0			
6.0	Consultations with community	Land for borrowing	Agreement to include borrow area rehabilitation	ECoP 5.0
		Water for construction	Agreements with owners/community for utilizing water	ECoP 8.0
		Site for construction camps	Rehabilitation of the land after construction	ECoP 3.0
		Removal of trees	Tree Plantation as per Roadside Plantation plan	ECoP 16.0
		Avoidance through modification of alignment	ECoP 15.0	

Sl.No.	Activity	Items to consider	Measures to address	Detailed in
		Cultural properties	Relocation costs to be covered in the project, if needs relocation	ECoP 15.0 ECoP 20.0
		Common property resources	Avoidance through modification of alignment Relocation, if needed in consultation with community	ECoP 2.0 ECoP 2.0
		Traffic during construction	Provision of alternate routes or prior notice to the users	ECoP 14.0
		Concerns of community	Community concerns to be incorporated	ECoP 1.0
7.0	Finalization of alignment	Environmental impacts identified	Impacts identified are to be mitigated by incorporation of provisions as per ECoPs	All ECoPs
		Design aspects	Impacts that can be mitigated through design modifications should be incorporated	ECoP 1.0
8.0	Preparation of detailed drawings	All concerns/impacts identified	Designs for enhancements and mitigation measures including cost provisions	All ECoPs
9.0	Monitoring of Progress	All environmental aspects identified	Monitoring implementation of Environmental measures	ECoP 18.0

**Table 1-4: Environmental Concerns during project implementation – to be identified in DPR**

Sl.No.	Activity and Sub Activity	Impact/s	Measure/s	ECoP Applicable
<b>A</b>	<b>Pre – Construction Activities</b>			
<b>A1.0</b>	<b>Alignment marking</b>	-Nil-	(i) Co-ordination with Revenue Department	ECoP 1.0 ECoP 2.0
<b>A2.0</b>	<b>Relocation of utilities</b>	Impact on current usage	(i) Identification of relocation site in advance (ii) Scheduling the activity in consonance with the community usage pattern	ECoP 2.0 ECoP 2.0
<b>A3.0</b>	<b>Tree Felling</b>	Compliance with Forest Act in case trees are on forest land Loss of canopy	(i) Prior clearance from Forest Department (ii) Tree plantation as per roadside plantation plan	ECoP 1.0 ECoP 16.0
<b>A4.0</b>	<b>Clearance of land</b>	Affect on livelihood Affect on standing crops Affect on cultural properties Affect on natural habitats	(i) As per project provisions (ii) Scheduling of activity and coordination (iii) Modification of alignment or Relocation of the cultural properties (iv) Avoidance of natural habitats or preparation of Natural Habitat Management Plan	ECoP2.0 ECoP 1.0 ECoP 15.0 ECoP 19.0
<b>A5.0</b>	<b>Diversion of forest land</b>	Compliance with Forest Act Affect on flora Pollution from construction activities	(i) Activity scheduling to avoid delays, conformance to legal requirements (ii) Precautionary measures during construction in forest areas (iii) Precautions while operating equipment/machinery	ECoP 1.0 All ECoPs ECoP 13.0
<b>A6.0</b>	<b>Transfer of land ownership</b>	Grievances from community Affect on livelihood	(i) Addressal through Grievance Redressal Mechanisms & Consultations (ii) Provision of entitlements as per resettlement framework	ECoP 1.0 ECoP 20.0 ECoP 1.0
<b>A7.0</b>	<b>Location of Storage Yards, labour camps, and construction sites</b>	Pollution from construction camps, storage yards & labour camps Pressure on local infrastructure	(i) Location criteria to be adopted (ii) Obtain clearances from SPCB (iii) Infrastructure arrangements to be as per guidelines	ECoP 3.0 ECoP 20.0 ECoP 1.0 ECoP 3.0
<b>A8.0</b>	<b>Procurement of equipments and machinery</b>	Machinery likely to cause pollution at settlements and natural habitats Safety concerns in machinery operation	(i) Machinery to be procured shall be in conformance with noise and emission standards of CPCB (ii) Safety equipment for workers	ECoP 13.0 ECoP 19.0 ECoP 14.0
<b>A9.0</b>	<b>Identification and Selection of Material Sources</b>	Conflict of uses in case of water Borrowing causes depressed lands Pollution due to material extraction from borrow and quarry areas to surrounding environment Disturbance to Natural Habitats	(i) Consultations and arrangements at contractor-individual levels, documentation of agreement (ii) Consultations and arrangements at contractor-individual levels, documentation of agreement (iii) Precautionary measures during siting of borrow areas and quarry areas (iv) Avoidance of location of material sources in Natural Habitats	ECoP 8.0 ECoP 20.0 ECoP 5.0 ECoP 5.0 ECoP 7.0 ECoP 19.0
<b>A10.0</b>	<b>Identification of designated locations of waste disposal</b>	Pollution due to location close to settlements, water bodies & other sensitive areas	(i) Site selection in conformance to criteria provided	ECoP 10.0
<b>B</b>	<b>Construction Activities</b>			
<b>B1.0</b>	<b>Site Clearance</b>			
B1.1	Clearing and Grubbing	Effect on roadside vegetation Debris generation creating unsightly conditions	(i) Restricting movement of machinery/equipment over adjacent fields (ii) Disposal / storage of grubbing waste and possible reuse	ECoP 2.0 ECoP 13.0 ECoP 10.0
B1.2	Dismantling of existing culverts and structures, if any	Generation of Debris creating unsightly conditions Flooding due to interception to drainage paths	(i) Disposal of waste and likely reuse (ii) Provision of diversion channels and/or scheduling construction of culverts preferably in dry months	ECoP 10.0 ECoP 12.0
<b>B2.0</b>	<b>Planning Traffic diversions and Detours</b>	Trampling of vegetation along traffic diversions	(i) Activity scheduling, identification of alternative track	ECoP 14.0
<b>B3.0</b>	<b>Material Procurement</b>	Loss of topsoil Formation of stagnant water pools due to borrowing/quarrying Illegal quarrying / sand mining Uncontrolled blasting at quarries	(i) Stripping & Storing topsoil (ii) Restoration plan for borrow areas & quarry areas (new quarry) (iii) Conformance of quarries selected to the SPCB requirements, including quarry rehabilitation plans (iv) Controlled blasting to the extent required. Conformance to blasting rules as per the Indian Explosives Act	ECoP 6.0 ECoP 5.0 ECoP 7.0 ECoP 7.0

Sl.No.	Activity and Sub Activity	Impact/s	Measure/s	ECoP Applicable
B4.0	Transport of materials to site	Fugitive emissions from transport trucks	(i) Covering of material with tarpaulin or use of covered box trucks during transport	ECoP 10.0
		Dust emissions from haul roads	(ii) Haul road management	ECoP 13.0
<b>B5.0</b>	<b>Materials handling at site</b>			
B5.1	Storage of materials	Contamination to water sources, leaching into ground water	(i) Provision of impervious base to storage areas	ECoP 3.0
B5.2	Handling of earth	Dust rising and increase in particulate concentration in ambient air	(ii) Use of dust suppressants	ECoP 13.0
B5.3	Handling of fly ash	Increase of particulate concentration and contamination of nearby areas	(iii) Use of dust suppressants	ECoP 4.0
B5.4	Handling of granular material	Risk of injury to workers	(iv) Use of Personal Protective Equipment	ECoP 14.0
B5.5	Handling of bituminous materials	Leaching of materials, contamination of water sources	(v) Provision of impervious base at bitumen storage areas	ECoP 10.0
		Air pollution	(vi) Control of emissions from mixing	ECoP 13.0
B5.6	Handling of oil/diesel	Contamination from accidental spills	(vii) Prevention of accidental spills, affecting cleaning immediately after spill	ECoP 13.0
		Pollution due to incomplete burning	(viii) Ensure complete combustion of fuel through regular maintenance of equipment	ECoP 13.0
B5.7	Waste management	Littering of debris at construction site	(ix) Waste to be disposed at disposal locations only	ECoP 10.0
		Contamination of surroundings due to runoff from construction site	(x) Prevention of runoff from entering water bodies	ECoP 11.0
B5.8	Operation of construction equipments and machinery	Air & Noise pollution	(xi) Conformance to Emission standards and norms	ECoP 13.0
		Operational safety of workers	(xii) Conformance to Safety concerns of the road users and workers in operation, first aid provision and mandatory provision of Personal Protective Equipment	ECoP 14.0
B5.9	Movement of Machinery	Trampling of vegetation	(xiii) Restriction of movement within ROW	ECoP 13.0
		Damage to flora & natural habitats	(xiv) Minimizing impact on vegetation	ECoP 13.0 ECoP 19.0
		Damage to road side properties	(xv) Minimizing impacts on private and common properties, including religious structures	ECoP 13.0 ECoP 15.0
<b>B6.0</b>	<b>Earthworks</b>			
B6.1	Cutting	Uncontrolled blasting in case of rock cutting	(i) Controlled blasting to be made mandatory	ECoP 7.0
		Loss of topsoil	(ii) Preservation of topsoil for reuse	ECoP 6.0
		Waste generation	(iii) Safe disposal of waste & possible reuse	ECoP 10.0
B6.2	Embankment construction	Interruption to drainage	(i) Drainage channels to be provided with culverts in advance to embankment construction as far as possible	ECoP 12.0
		Dust Rising	(ii) Dust suppression with water	ECoP 13.0
		Excess water/material usage	(iii) Minimising height of embankment	ECoP 1.0
			(iv) Scheduling embankment construction preferably in wet months, if possible	ECoP 1.0
			(v) Compaction with vibratory rollers is suggested	ECoP 1.0
		Erosion causing impact on embankment/slope stability	(v) Slope stabilization measures as seeding, mulching & bio-engineering techniques	ECoP 9.0
		Formation of rills / gullies	(vi) Construction of temporary erosion control structures as per requirements	ECoP 9.0
		Contamination of water bodies/ water courses	(vii) Control measures as silt fencing, vegetative barriers etc	ECoP 9.0
	(viii) Avoiding disposal of liquid wastes into natural water courses	ECoP 11.0		
B6.3	Maintenance at construction camp	Collection of rainwater in construction camps	(ix) Temporary drains during construction	ECoP 3.0
		Waste water from labour camps	(x) Disposal of waste water into soak pits	ECoP 3.0
		Contamination of soil	(xi) Removal of oil / other chemical spills & wastes	ECoP 3.0
B6.4	Cutting embankments of surface water bodies	Impact on the drainage flows in and out of the water body	(xii) Restoration of drainage channels	ECoP 11.0
		Embankment stability	(xiii) Design of slopes of the water bodies, slope protection etc	ECoP 9.0
<b>B7.0</b>	<b>Sub-Base &amp; Base courses</b>			
B7.1	Granular sub-base	Extensive extraction of quarry materials	(i) Use of locally available materials (licensed quarry)	ECoP 4.0
B7.2	Wet mix macadam	Extensive water requirement	(ii) Scheduling the activity preferably in wet months	ECoP 1.0
			(iii) Avoiding conflict of uses due to water extraction from construction	ECoP 8.0
B7.3	Shoulders treatment	Movement of Machinery for compaction	(iv) Restricting movement on adjacent lands	ECoP 13.0
B8.0	Culverts and Minor Bridge Works	Interruption to water flow	(i) Provision of diversion channels	ECoP 12.0
		Pollution of water channels during construction	(ii) Control of sediment runoff	ECoP 12.0
		Safety of Workers	(iii) Mandatory use of Personal Protective Equipment	ECoP 14.0
<b>B9.0</b>	<b>Surfacing</b>			
B9.1	Bituminous surface	Worker's safety during handling of hot mix	(i) Mandatory use of Personal Protective Equipment	ECoP 14.0
		Damage to vegetation (burning/ cutting)	(ii) Avoiding use of wood as fuel for heating bitumen as far as possible	ECoP 13.0
			(iii) Hot mix plant location to be preferably on waste lands	ECoP 13.0
		Contamination due to bituminous wastes	(iv) Reuse or Land filling of bituminous wastes or use in sub-base	ECoP 10.0
		Impacts on Air quality	(v) Ensuring compliance of hotmix plants with the CPCB emission standards	ECoP 13.0
B9.2	Concrete surfacing for roads crossing built up areas	Contamination of surroundings due to concrete mixing	(vi) Mixing concrete at designated locations away from habitation and agriculture lands	ECoP 3.0

Sl.No.	Activity and Sub Activity	Impact/s	Measure/s	ECOP Applicable
<b>B10.0</b>	<b>Road furniture/Signage</b>	-Nil-	To be provided as per design	
<b>B11.0</b>	<b>Shoulder protection</b>	Requires material extraction from quarries	(i) Use locally available material (licensed quarry)	ECOP 4.0
			(ii) Ensure that all shoulders are clear of debris or construction materials	ECOP 13.0
<b>B12.0</b>	<b>Enhancements</b>	-Nil-	(i) To be included in DPR	ECOP 1.0 ECOP 20.0
<b>B13.0</b>	<b>Monitoring environmental conditions</b>	-Nil-	(i) To be as per the codes of environmental practice	ECOP 18.0
<b>C</b>	<b>Post Construction Activities</b>			
<b>C1.0</b>	<b>Clearing of construction camps</b>			
C1.1	Campsite restoration	Change of landuse due to setting up of construction camp	(i) Campsite to be restored to its original condition as per the rehabilitation plan	ECOP 3.0
			(ii) Restoration of top soil	ECOP 6.0
C1.2	Dismantling of campsite	Waste generation at the construction site	(iii) Disposal of waste at designated locations	ECOP 10.0
<b>C2.0</b>	<b>Clearing of Water Channels, side drains and culverts</b>	Generation of debris & silt	(i) Removal of Debris and disposal	ECOP 11.0 ECOP 12.0
<b>C3.0</b>	<b>Rehabilitation of borrow areas</b>	-Nil-	(i) Top soil restoration, revegetation	ECOP 5.0
<b>C4.0</b>	<b>Clearing of encroachments</b>	Loss of livelihood	(i) Precautionary measures to avoid encroachments	ECOP 17.0

# ECoP-2.0 Site Preparation

---

## 2.1 General

2.1.1 The preparation of site for construction involves: (i) Marking and clearance of the required RoW of all encroachments by the PIU prior to mobilization of Contractor; and, (ii) Site preparation by the Contractor prior to commencement of construction. Scope of this ECoP includes only the measures to address environmental concerns expected during the site preparation. The land acquisition and resettlement issues involved are to be addressed by PIU as per the provisions of the Resettlement Framework for the project.

## 2.2 Site Preparation Activities by the PIU

2.2.1 After determining the alignment in consultation with local community / Gram Panchayat, the PIU shall be responsible to stake out the alignment. It shall be the responsibility of the PIU to take over the possession of the proposed RoW and hand over the land width required clear of all encumbrances to the Contractor who shall establish bench marks on ground.

2.2.2 The addressal of social and resettlement issues shall be carried out by the PIU as per the provisions of the Resettlement Framework and the Screening and Consultation Framework. Activities pertaining to the clearance of land and relocation of utilities need to be initiated by the PIU well in advance to avoid any delays in handing over of site to the Contractor. Assistance of the Revenue Department shall be sought in accomplishing the task through Departmental Instructions.

PIU's responsibilities before handing over site...	
#	Clearance of encroachments within proposed RoW
#	Initiation of process for legal transfer of land title
#	Alignment modification or Relocation of common property resources in consultation with the local community
#	Alignment modification or Relocation/removal of utilities in consultation with the various government departments and
#	Obtain clearances required from government agencies for
o	Felling trees and
o	Diversion of stretches of forestlands etc.

## 2.3 Site Preparation Activities by the Contractor

2.3.1 The contractor shall submit the schedules and methods of operations for various items during the construction operations to the PIU for approval. The Contractor shall commence operations at site only after the approval of the schedules by the PIU.

2.3.2 The activities to be undertaken by the contractor during the clearing and grubbing of the site are as follows:

2.3.3 The clearance of site shall involve the removal of all materials such as trees, bushes, shrubs, stumps, roots, grass, weeds, part of topsoil and rubbish. Towards this end the Contractor shall adopt the following measures: (i) Limiting the surface area of erodible earth material exposed by clearing and grubbing (ii) Conservation of top soil and stock piling as per the provisions of specifications or **ECoP-6.0**, "Topsoil Salvage, Storage and Replacement" and (iii) Carry out necessary backfilling of pits resulting from uprooting of trees and stumps with excavated or approved materials to the required compaction conforming to the surrounding area.

2.3.4 To minimize the adverse impact on flora and vegetation, only ground cover/shrubs that impinge directly on the permanent works shall be removed. Cutting of trees and vegetation outside the working area shall be avoided under all circumstances. In case the alignment passes through forest areas, Forest Ranger shall be consulted for identification of presence of any

rare/endangered species with in the proposed road way. Protection of such species if found shall be as per the directions of the Forest Department.

- 2.3.5 The locations for disposal of grubbing waste shall be finalized prior to the start of the works on any particular section of the road. The selection of the site shall be approved by the PIU. The criteria for disposal of wastes shall be in accordance with **ECoP-10.0**, “Waste management”.
- 2.3.6 In locations where erosion or sedimentation is likely to be a problem, clearing and grubbing operations should be so scheduled and performed that grading operations and permanent erosion and sedimentation control features can follow immediately, if the project conditions permit.
- 2.3.7 Dismantling of CD structures and culverts shall be carried out in a manner as not to damage the remaining required portion of structures and other surrounding properties. The disposal of wastes shall be in accordance with the provisions of **ECoP-10.0**, “Waste management”. The following precautions shall be adopted: (i) The waste generated shall not be disposed off in watercourses, to avoid hindrance to the flow, and (ii) All necessary measures shall be taken while working close to cross drainage channels to prevent earthwork, stonework as well as the method of operation from impeding cross drainage at rivers, streams, water canals and existing irrigation and drainage systems.
- 2.3.8 The designated sites duly approved by Implementing Agency shall be cleared of its existing cover for setting up of the construction sites, camps and related infrastructure facilities, borrow areas and other locations identified for temporary use during construction. The contractor shall comply with all safety requirements in consideration as specified in **ECoP-14.0**, “Public & Worker’s Health and Safety”. Before initiation of site preparation activities along these lands to be used temporarily during construction, it shall be the responsibility of the Contractor to submit and obtain approval of the site restoration plan from the implementing agency. The letter/contract agreement between the owner(s) of the land parcel for temporary usage shall include site restoration as near as possible to its original status. The guidelines for the same are furnished in **ECoP-13.0**, “Construction Plants & Equipment Management”; **ECoP-3.0**, “Construction Camps”; and **ECoP-5.0**, “Borrow areas”.
- 2.3.9 Site preparation shall involve formation of the road base wherein it is ready for construction of protective/drainage works, carriageway, shoulders, parapets and other road furniture. In hilly terrain, trace cut are already undertaken by the PIU during surveys for alignment marking and design preparation. Implementing Agency shall transfer the land for civil works to the Contractor. Peg marking of the alignment and setting out for the proposed roadwork shall be carried out by the contractor as per detailed drawings and got checked by the supervising engineers.

## ECOP-3.0 Construction Camps

### 3.1 General

- 3.1.1 The terms and conditions of this Code of Practice pertain to the siting, development, management and restoration of construction camps to avoid or mitigate impacts on the environment. The area requirement for the construction camp shall depend upon the size of contract, number of labourers employed and the extent of machinery deployed. The key activities requiring addressal during the project stages and the significance of impacts in the project regions are presented in **Table 3-1**.

**Table 3-1: Significance of Impacts Across Project Regions**

Stages	Key Activities	Significance of Impacts							
		Rajasthan		Himachal		Uttar Pradesh		Jharkhand	
		Arid	Other areas	Low hills	High hills	Flood plains	Other areas	Hills	Plateau
Pre-construction	Siting								
	Development								
Construction	Maintenance								
Post-construction	Restoration								
	Impacts not likely to be significant								
	Impacts likely to be significant								

### 3.2 Pre-construction stage

- 3.2.1 The Contractor shall identify the site for construction camp in consultation with the individual owners in case of private lands and the Gram Panchayat in case of Government lands. The suitable sites shall be selected and finalized in consultation with the PIU.
- 3.2.2 The contractor will work out arrangements for setting up his facilities during the duration of construction with the land owner/Gram Panchayat. The arrangements will include the restoration of the site after the completion of construction. The arrangements will be verified by the PIU /GS to enable redressal of grievances at a later stage of the project.

Selection of construction camp/site locations	
<p><b>Avoid the following ...</b></p> <ul style="list-style-type: none"> <li>⊘ Lands close to habitations</li> <li>⊘ Irrigated agricultural lands</li> <li>⊘ Lands belonging to small farmers</li> <li>⊘ Lands under village forests</li> <li>⊘ Lands within 100m of community water bodies and water sources as rivers</li> <li>⊘ Lands within 100m of watercourses</li> <li>⊘ Low lying lands</li> <li>⊘ Lands supporting dense vegetation</li> <li>⊘ Grazing lands and lands with tenure rights</li> <li>⊘ Lands where there is no willingness of the landowner to permit its use</li> </ul>	<p><b>Prefer the following ...</b></p> <ul style="list-style-type: none"> <li>⊘ Waste lands</li> <li>⊘ Lands belonging to owners who look upon the temporary use as a source of income</li> <li>⊘ Community lands or government land not used for beneficial purposes</li> <li>⊘ Private non-irrigated lands where the owner is willing and</li> <li>⊘ Lands with an existing access road</li> </ul>

- 3.2.3 After finalization of the site, the contractor shall submit to the PIU a detailed layout plan for development of the construction camp, indicating the various structures to be constructed including the temporary structures to be put up, drainage and other facilities. The plan will include the redevelopment of sites to pre-construction stage. The campsite should cover an area of about 3000 sq.m for 60 Nos of workers. A conceptual drawing of the construction camp layout is presented as **Annexure 3-1**.

3.2.4 Accommodation: The contractor shall provide, free of cost in the camp site, temporary living accommodation to all the workers employed by him for such a period as the construction/maintenance work is in progress.

<b>Arrangements with landowners...</b>
The contractor shall submit to PIU the following:
## Written No-objection certificate of the owner/cultivator
## Extent of land required and duration of the agreement
## Photograph of the site in original condition
## Details of site redevelopment after completion

3.2.5 Towards the provision and storage of drinking water at the construction camp, the contractor shall ensure the following provisions:

- ## The contractor shall provide for a sufficient supply of potable water in the construction camps, in earthen pots or any other suitable containers. The contractor shall identify suitable community water sources as handpumps and ponds for procuring drinking water, in consultation with the Gram Panchayat.
- ## Only in the event of non-availability of other sources of potable water, the Contractor shall obtain water from an unprotected source, after the testing for its potability. Where water has to be drawn from an existing open\_well, the well shall be properly chlorinated before water is drawn from it for drinking. All such wells shall be entirely closed in and be provided with dust proof trap door.
- ## Every water supply or storage shall be at a distance of not less than 15m from any wastewater / sewage drain or other source of pollution. Water sources within 15m proximity of toilet, drain or any source of pollution will not be used as a source of drinking water in the project.
- ## A pump shall be fitted to each covered well, the trap door shall be kept locked and opened only for cleaning or inspection, which shall be done at least once a month.

3.2.6 In every site, adequate and suitable facilities for washing clothes and utensils shall be provided and maintained for the use of contract labor employed therein. Separate and adequate bathing facilities shall be provided for the use of male and female workers. Such facilities shall be conveniently accessible and shall be kept in clean and hygienic conditions.

3.2.7 Sanitary arrangements, latrines and urinals shall be provided in every work place on the following scale:

- ## Where female workers are employed, there shall be at least one latrine for every 25 females or part thereof.
- ## Where males are employed, there shall be at least one latrine for every 25 males or part thereof.
- ## Every latrine shall be under cover and so partitioned off as to secure privacy, and shall have a proper door and fastenings.
- ## Where workers of both sexes are employed, there shall be displayed outside each block of latrine and urinal, a notice in the language understood by the majority of the workers "For Men Only" or "For Women Only" as the case may be.
- ## The latrines and urinals shall be adequately lighted and shall be maintained in a clean sanitary condition at all times and
- ## Water shall be provided in or near the latrines and urinals by storage in suitable containers.

3.2.8 Arrangements for Waste Disposal

- ## Disposal of sanitary wastes and excreta shall be into septic tanks.
- ## Kitchen wastes shall be disposed into soak pits. Wastewater from campsites will be discharged and disposed in a kitchen sump located preferably at least 15 meters from any body of water. Sump capacity should be at least 1.3 times the maximum volume of wastewater discharged per day. The bottom of the pit should be filled with coarse gravel and the sides shored up with board, etc. to prevent erosion and collapse of the pit.
- ## Solid wastes generated in the construction site shall be reused if recyclable or disposed off in land fill sites

3.2.9 First Aid Facilities

- ## First Aid Box will be provided at every construction campsite and under the charge of a responsible person who shall always be readily available during working hours of the work place. He shall be adequately trained in administering first aid-treatment. Formal arrangement shall be prescribed to carry injured person or person suddenly taken ill to the nearest hospital.

### 3.2.10 Storage Site

- ⌘ Storage of Petrol/Oil/Lubricants: Brick on edge flooring or sand flooring will be provided at the storage places of Petrol/Oil/Lubricants to avoid soil and water contamination due to spillage.
- ⌘ Storage of cement: Damp-proof flooring, as per IS codes
- ⌘ Storage of blasting materials: Shall be as per the specific provisions of law.

### 3.2.11 Fire fighting arrangement

- ⌘ Demarcation of area susceptible to fires with cautionary signage,
- ⌘ Portable fire extinguishers and/or sand baskets shall be provided at easily accessible locations in the event of fire,
- ⌘ Contractor shall educate the workers on usage of these equipments

### 3.2.12 Interactions with host communities

- ⌘ To ensure that there is no conflict of the migrant labor with the host communities, the contractor shall issue identity cards to labourers and residents of construction camps.

## 3.3 Construction Stage

3.3.1 Construction camps shall be maintained free from litter and in hygienic condition. It should be kept free from spillage of oil, grease or bitumen. Any spillage should be cleaned immediately to avoid pollution of soil, water stored or adjacent water bodies. Following precautions need to be taken in construction camps.

- ⌘ Measures to ensure that no leaching of oil and grease into water bodies or underground water takes place
- ⌘ Wastewater should not be disposed into water bodies
- ⌘ Regular collection of solid wastes should be undertaken and should be disposed off safely
- ⌘ All consumables as the first aid equipment, cleaning equipment for maintaining hygiene and sanitation should be recouped immediately

3.3.2 PIU will monitor the cleanliness of construction campsites and ensure that the sites are properly maintained throughout the period of the contract.

## 3.4 Post Construction Stage

3.4.1 At the completion of construction, all construction camp facilities shall be dismantled and removed from the site. The site shall be restored to a condition in no way inferior to the condition prior to commencement of the works. Various activities to be carried out for site restoration are:

- ⌘ Oil and fuel contaminated soil shall be removed and transported and buried in waste disposal areas.
- ⌘ On the construction camp site, saplings of species similar to that of cut trees shall be planted.
- ⌘ Saplings planted shall be handed over to the community or the land owner for further maintenance and watering
- ⌘ Soak pits and septic tanks shall be covered and effectively sealed off.



## **ECOP-4.0 Alternate Materials for Construction**

---

### **4.1 General**

- 4.1.1 The use of alternate materials for construction focuses on the management and reuse of waste materials locally available in the project area with the added advantage of economizing the project cost incase lead for usual road materials is high. Potential waste materials that can be used in PMGSY include: fly ash, blast furnace slag, marble slurry, quarry overburden, and other industrial wastes. Lime or mechanical stabilization techniques should be utilised in case the materials available around the project area is not suitable for construction in its original condition. The guidelines for the use of waste materials in rural roads construction are laid down in IRC:SP-20:2002. This code of practice focuses on the feasibility of adoption of these materials for construction in the four project states.
- 4.1.1.1 Details of material available in Rajasthan for all districts along with their suitability are available with Rajasthan PWD. This information should be utilized in determining the alternate material for the particular areas. For other States, alternate materials availability and suitability shall be determined by the respective States.

### **4.2 Project Preparation Stage**

- 4.2.1 During the DPR stage, the sources and suitability of alternate materials should be identified. In case of availability of alternate materials, the DPR shall specify the following: (i) Characteristics and availability of the material (ii) Possibility of use in the project (iii) Methods of testing, specifications, recommended usage and (iv) Mechanism for procuring and transporting to the site. The feasibility of its use shall be based on the lead from the project corridor, suitability of the material and the extent of use.
- 4.2.2 The PIU must ensure that provision shall be made in bid document under special conditions of contract specifying the use of fly ash, if available in the vicinity of the project area as per the central government directive on the issue.
- 4.2.3 A separate BoQ to be included for alternate materials in case they are available in the proximity of the project area

### **4.3 Pre-construction Stage**

- 4.3.1 Testing shall be done as per IS specifications, in order to evaluate suitability of the alternate materials. In case test results do not match the specifications; option of blending the material with standard materials to meet the required specifications should be explored.
- 4.3.2 The Contractor shall approach the supplier identified based on lead and material suitability and shall sign an agreement specifying the quantity of the material to be procured.
- 4.3.3 In case quarry overburden is to be used as fill material, a Memorandum of Understanding (MoU) between the quarry owner and the contractor would be signed. The format for MoU would be as per **Annexure 4-1**.

### **4.4 Construction Stage**

- 4.4.1 The procured alternate material shall be transported by the contractor at his own cost
- 4.4.2 In case of fly ash as an alternate material, as per MoEF Notification, S.O. 1164(E), dated 5<sup>th</sup> November 2002, within the 100 km radius of thermal power plants, it is the responsibility of the Contractor to transport the fly ash to the construction site.

- 4.4.3 Care should be taken that all the loose material (fly ash, quarry overburden, etc) shall be covered to avoid fugitive emissions during transportation to avoid spillages
- 4.4.4 In case of transporting slag as well as marble slurry, free board should be maintained and tailboard should be properly closed and sealed
- 4.4.5 While storing the alternate material, Contractor shall undertake all precautionary measures to prevent leaching of the materials
- 4.4.6 PIU must ensure that the use of alternate material is as per specifications

## 4.5 Description of Alternate Materials

- 4.5.1 Blast Furnace Slag: The iron and steel plants produce large quantities of waste known as blast furnace slag. While producing 1 ton of steel, nearly an equivalent amount of slag is generated. Hence, the disposal of this slag is of great concern. The engineering properties of this material reflect high bearing capacity as well as good interlocking between slag and aggregate.
- 4.5.2 Blast furnace slag after testing can be used as pavement material as a base or sub-base, either bound or unbound. IRC:SP-20:2002, Chapter 9, gives a brief description of different types of slag available and test method to check their suitability.
- 4.5.3 Fly Ash: MoEF Notification, S.O. 1164(E), dated 5<sup>th</sup> November 2002, GoI has made mandatory the use of fly ash within a radius of 100 km from coal or lignite based thermal power plants. Detailed design specifications for the use of fly ash are given in IRC:SP-20:2002, Chapter 9. General requirements of the material for embankment construction with fly ash is given in IRC:SP-58:2001.
- 4.5.4 With the reference to the IRC:SP-20:2002, Chapter 9, Figure 9.3 “Typical cross-section of the embankment with core of fly ash”, considering the formation width 7.5 m and base / sub base height 0.33 m, only at those places where embankment height is greater than 0.83 m fly ash can be used. **Table 4-1** highlights the percentage reduction in the quantity of earth.

**Table 4-1 Reduction in earth requirement for embankment heights 0.5 & 1.0m by using fly ash**

	Embankment ht - 0.5m	Embankment ht - 1.0 m
Formation Width (m)	7.50	7.50
Carriage Way (m)	3.75	3.75
Embankment Height (m)	0.50	1.00
Surface Course + Base + Sub Base (m)	0.33	0.33
Earthen Shoulder (m)	1.88	1.88
Amount of Soil in Sub Grade (cu m)	1.56	6.81
Amount of Soil in Earthen Shoulder (cu m)	1.46	1.46
Total Soil Requirement (cu m)	<b>3.01</b>	<b>8.26</b>
<b>In case of Fly Ash</b>		
Amount of Flyash (cu m)	<b>Fly ash cannot be used</b>	<b>1.22</b>
Amount of Earth Require (cu m)	3.01	7.05
% Reduction in Amount of Earth	<b>0.00</b>	<b>14.73</b>

- 4.5.5 Quarry Over-Burden: While procuring the aggregates, sand and sub-base material from the quarries, large amount of overburden is generated that can be utilized as fill material for construction of embankment, bridge approaches as well as during the construction of pipe culverts as a cushion.
- 4.5.6 In case quarry operator is other than the Contractor, it is the sole responsibility of the Contractor to procure the overburden. The Contractor must sign an agreement with the quarry owner

specifying the details of type of overburden, quantity and the responsibility to transport the overburden. A copy of the agreement has to be submitted to the PIU

4.5.7 Marble Slurry: It is a waste product of the marble industry can be successfully used in: -

- ☞ Construction of road pavement layers
- ☞ Construction of embankments
- ☞ Back fill material for retaining walls and
- ☞ In mass concrete work as a replacement of fine aggregate i.e. sand upto 40%

4.5.8 Use of Construction Scrap / Waste:

- ☞ In case an upgradation of either National or State Highway, is in progress in the proximity of the PMGSY project road, the construction wastes generated shall be utilized as an alternate material for the PMGSY road construction.
- ☞ Table 10-2 of **ECoP-10.0**, “Waste Management” identifies commonly generated construction waste that can be utilized during the construction of PMGSY road. Care shall be taken to segregate waste from the mix before reuse.
- ☞ Soil Stabilisation: In soils as black cotton or clayey soils, stabilization techniques as per IRC:SP-20:2002 shall be adopted.

<b>ENGINEERING PROPERTIES OF BLAST FURNACE SLAG</b>	
☞	<i>Gradation:</i> Steel slag aggregate used in hot mix asphalt and for surface treatment should meet the gradation requirement as conventional aggregate.
☞	<i>Specific Gravity:</i> Due to the relatively high specific gravity (3.2 to 3.6) of steel slag, steel slag aggregate can be expected to yield a higher density product compared with that of conventional mixes (2.5-2.7). Bulk relative densities are 15 to 25 percent greater than most conventional mixes.
☞	<i>Durability:</i> Steel slag aggregate is very hard and abrasion resistant. Steel slag aggregates display good durability with resistance to weathering and erosion.
☞	<i>Moisture Content:</i> The relatively rough surface texture (deep pores) of steel slag increases the susceptibility of the aggregate to differential drying and potential retention of moisture in the hot mix. Moisture retention coupled with the presence of oxides prone to hydration could result in volumetric instability. To minimize drying requirements and the potential for hydration reactions, steel slag aggregate moisture content should be limited to 5 percent prior to use in hot mix asphalt. The moisture content of the steel slag aggregate after drying should be no greater than 0.1 percent.
☞	<i>Frictional Properties:</i> The results of polished stone values (PSV, high values desirable) and aggregate abrasion values (AAV, low values desirable) supports the general finding that steel slag aggregate exhibits superior frictional resistance for pavements. The high frictional resistance, as well as the abrasion resistance of steel slag aggregate, is advantageous in applications where high wear resistance is required, such as intersections and parking areas.
☞	<i>Thermal Properties:</i> Steel slag aggregates have been reported to retain heat considerably longer than conventional natural aggregates. The heat retention characteristics of steel slag aggregates can be advantageous for hot mix asphalt repair work during cold weather.
☞	<i>Stability:</i> Steel slag aggregate mixes combine very high stabilities (1.5 to 3 times higher than conventional mixes) with good flow properties.
☞	<i>Stripping Resistance:</i> Steel slag mixes typically exhibit excellent resistance to stripping of asphalt cement from the steel slag aggregate particles. Resistance to stripping is probably enhanced because of the presence of free lime in the slag.
☞	<i>Rutting Resistance:</i> The high stability (1.5 to 3 times higher than conventional mixes) with good flow properties results in a mix that resists rutting after cooling, but can still be compacted. Rutting resistance is advantageous for highways, industrial roads, and parking areas subjected to heavy axle loads.



# ECOP-5.0 Borrow Areas

## 5.1 General

5.1.1 Embankment fill material is to be procured from borrow areas designated for the purpose. The properties of the borrow material shall be got tested and recorded on Format 4.1 of IRC:SP-20:2002. Scope of this ECoP extends to measures that need to be incorporated during borrow area location, material extraction and rehabilitation. **Table 5-1** presents key activities involved in borrowing material and the significance of impacts across the project regions.

**Table 5-1: Significance of Impacts Across Project Regions**

Stages	Key Activities	Significance of Impacts							
		Rajasthan		Himachal		Uttar Pradesh		Jharkhand	
		Arid	Other areas	Low hills	High hills	Flood plains	Other areas	Hills	Plateau
Pre-construction	Locating Borrow Areas								
	Stripping & Stockpiling								
Construction	Material Extraction								
Post-Construction	Reclamation of Borrow Areas								
	Impacts not likely to be significant								
	Impacts likely to be significant								

## 5.2 Project Planning and Design Stage

Earth requirement can be reduced through...	
Measure	Extent of reduction of earth requirement
Reduction of formation width from 7.5 m to 6.0 m in stretches where traffic volume is low	23 %.
Restriction of embankment height to 0.3-0.5 m in areas receiving annual rainfall less than 400mm or at locations where natural drainage is not obstructed and the finished level of the pavement is 0.6-0.8m above the adjoining ground	24%
Use of flyash as an alternate fill material, within a radius of 100 km of Coal or Lignite based thermal power plant as per MoEF Notification, Part II, Section 3, Sub-section (ii), 2002, S.O. 1164(E)	15 %
Industrial and quarry wastes will be utilized as fill material in embankments where suitable material is available.	Varies dependent upon the nature of material

5.2.1 Design measures for reduction in quantity of earth work will have to be undertaken to reduce the quantity of material extracted and consequently decrease the borrow area requirement.

5.2.2 Borrow area siting should be in compliance with IRC:10-1961. The DPR shall contain (i) Guidelines for locating site of borrow areas (ii) The arrangements to be worked out with the land owner/community for the site and (iii) Sample designs for redevelopment of borrow areas.

## 5.3 Pre-construction stage

5.3.1 The contractor shall identify the borrow area locations in consultation with the individual owners in case of private lands and the Gram Panchayat in case of Government lands, after assessing the suitability of the material. The suitable sites shall be selected and finalised in consultation with the PIU.

Borrowing to be avoided on...	Practices to avoid...
<ul style="list-style-type: none"> <li>⊘ Lands close to toe line, but in no case less than 1.5m</li> <li>⊘ Irrigated agricultural lands</li> <li>⊘ Grazing land</li> <li>⊘ Lands within 0.8km of settlements</li> <li>⊘ Environmentally sensitive areas               <ul style="list-style-type: none"> <li>○ Designated protected areas / forests</li> <li>○ Unstable side-hills</li> <li>○ Water-bodies</li> <li>○ Wetlands</li> <li>○ Streams and seepage areas</li> <li>○ Areas supporting rare plant/ animal species</li> </ul> </li> </ul>	<ul style="list-style-type: none"> <li>⊘ Borrowing adjoining road embankment</li> </ul> 

5.3.2 The Contractor will work out arrangements for borrowing with the land owner/Gram Panchayat. The arrangements will include the redevelopment after completion of borrowing. The arrangements will be verified by the PIU /GS to enable redressal of grievances at a later stage of the project. The Engineer of PIU shall approve the borrow area after inspection of the site to verify the reclamation plan and its suitability with the contractor and landowner. The contractor shall commence borrowing soil only after the approval by the PIU.

Arrangements with landowners...	Redevelopment plan to address...
<ul style="list-style-type: none"> <li>⊘ Contractor shall submit to PIU</li> <li>⊘ Written No-objection certificate of the owner/cultivator</li> <li>⊘ Extent of land required and duration of the agreement</li> <li>⊘ Photograph of the site in original condition</li> <li>⊘ Details of site redevelopment after completion</li> </ul>	<ul style="list-style-type: none"> <li>⊘ Land use objectives and agreed post-borrowing activities</li> <li>⊘ Physical aspects (landform stability, erosion, re-establishment of drainage)</li> <li>⊘ Biological aspects (species richness, plant density,) for areas of native revegetation</li> <li>⊘ Water quality and soil standards</li> <li>⊘ Public safety issues</li> </ul>

## 5.4 Construction stage

5.4.1 No borrow area shall be operated without permission of the Engineer. The procurement of borrow material should be in conformity to the guidelines laid down in IRC:10-1961. In addition, the contractor should adopt the following precautionary measures to minimise any adverse impacts on the environment:

- i). The unpaved surfaces used for haulage of borrow materials will be maintained dust free by the contractor through sprinkling of water twice a day during the period of use.
- ii). To avoid any embankment slippage, the borrow areas will not be dug continuously, and the size and shape of borrow pits will be decided by the Engineer.
- iii). Borrow pits situated less than 0.8 km (if unavoidable) from villages and settlements should not be dug for more than 30 cm after removing 15cm of topsoil and should be drained.
- iv). The Contractor shall maintain erosion and drainage control in the vicinity of all borrow pits and make sure that surface drains do not affect the adjacent land or future reclamation. This needs to be rechecked by the engineer of the PIU.
- v). In case the borrow pit is on agricultural land, the depth of borrow pits shall not exceed 45 cm and may be dug out to a depth of not more than 30 cm after stripping the 15 cm top soil aside. In case of stripping and stockpiling of topsoil, provisions of **ECOP-6.0**, “Topsoil Salvage, Storage and Replacement” need to be followed.
- vi). To prevent damages to adjacent properties, the Contractor shall ensure that an undisturbed buffer zone exists between the distributed borrow areas and adjacent land. Buffer zone shall be 3 m wide or equal to the depth of excavation whichever is greater.

- vii). In case of riverside, borrow pit should be located not less than 15m from the toe of the bank, distance depending on the magnitude and duration of flood to be withstood.
- viii). In no case shall be borrow pit be within 1.5m from the Toe line of the proposed embankment.

## 5.5 Post Construction Stage

5.5.1 All reclamation shall begin within one month of abandonment of borrow area, in accordance with the redevelopment plan. The site shall be inspected by the PIU after implementation of the reclamation plan.

5.5.2 Certificate of Completion of Reclamation is to be obtained by the Contractor from the landowner that “the land is restored to his satisfaction” (format attached as **Annexure**

**5-1**). The final payment shall be made after the verification by PIU.

### Checklist of items for inspection by PIU ...

- # Compliance of post-borrowing activities and land use with the reclamation plan
- # Vegetation density targeted, density achieved in case of re-vegetation, species planted as per reclamation plan
- # Drainage measures taken for inflow and outflows in case borrow pit is developed as a detention pond
- # Decrease of risk to public due to reclamation
- # Condition of the reclaimed area in comparison with the pre-borrowing conditions

### Redevelopment of borrow areas- Possible options...

Depending on the choice of the individual land owner/community, the contractor shall prepare redevelopment plans for the borrow areas. The options can be: (i) Restoring the productive use of the land (ii) Development of detention ponds in barren areas.

**Option I:** Suitable in locations with high rainfall and productive areas

- i). Topsoil must be placed, seeded, and mulched within 30 days of final grading if it is within a current growing season or within 30 days of the start of the next growing season.
- ii). Vegetative material used in reclamation must consist of grasses, legumes, herbaceous, or woody plants or a combination thereof, useful to the community for the fuel and fodder needs.
- iii). Plants must be planted during the first growing season following the reclamation phase.
- iv). Selection and use of vegetative cover must take into account soil and site characteristics such as drainage, pH, nutrient availability, and climate to ensure permanent growth.
- v). The vegetative cover is acceptable if within one growing season of seeding, the planting of trees and shrubs results in a permanent stand, or regeneration and succession rate, sufficient to assure a 75% survival rate.

**Option II:** In barren land, the borrow areas can be redeveloped into detention ponds. These will be doubled up as water bodies and also for removal of sediment from runoff flowing through the ponds. Design of the detention basin depends upon the particle size, settling characteristics, residence time and land area. A minimum of 0.02 mm size particle with a settling velocity of 0.02 cm/sec (assuming specific gravity of solids 2.65) can be settled in the detention basin. The design area of detention basin is based on the following equation:

$$A \geq \frac{1.2\Delta Q}{\tau}$$

Where A = Area in Sq.m, Q = Discharge in Cum and  $\tau$  = Settling velocity, cm/s

Following parameters are to be observed while setting up a detention pond

- i). Pond should be located at the lowest point in the catchment area. Care should be taken that the horizontal velocity should be less than settling velocity to prevent suspension or erosion of deposited materials.
- ii). Minimum Effective Flow Path: 5 times the effective width
- iii). Minimum Free Board: 0.15 m
- iv). Minimum Free Settling Depth: 0.5 m
- v). Minimum Sediments Storage Depth: 0.5 m
- vi). Maximum interior slope: 2H : 1V
- vii). Maximum exterior slope: 3H : 1V
- viii). The inlet structure should be such that incoming flow should distribute across the width of the pond.
- ix). A pre-treatment sump with a screen should provide to remove coarse sediments.
- x). Settled sediment should be removed after each storm event or when the sediment capacity has exceeded 33% of design sediment storage volume.
- xi). Accumulated sediment must be disposed of in a manner, which will prevent its re-entry into the site drainage system, or into any watercourse.



# ECoP-6.0 Topsoil Salvage, Storage and Replacement

## 6.1 General

6.1.1 Loss of topsoil is a long term impact along PMGSY roads due to (i) site clearance and widening for road formation (ii) development of borrow areas (iii) temporary construction activities as construction camps, material storage locations, diversion routes etc. Scope of this ECoP includes removal, conservation and replacement of topsoil likely to be impacted. **Table 6-1** lists the key activities that need to be addressed during project stages and the significance of impacts in the project regions.

**Table 6-1: Significance of Impacts across Project Region**

Stages	Key Activities	Significance of Impacts							
		Rajasthan		Himachal		Uttar Pradesh		Jharkhand	
		Arid	Other areas	Low hills	High hills	Flood plains	Other areas	Hills	Plateau
Pre-construction	Setting up construction activities								
Construction	Stripping & Stockpiling								
	Erosion Control Measures								
Post Construction	Reuse of Topsoil								
Impacts not likely to be significant									
Impacts likely to be significant									

## 6.2 Project Planning & Design Stage

6.2.1 The alignment finalisation shall be done to minimise uptake of productive land, as laid down in **ECoP-1.0**, “Project Planning and Design”. At the project preparation stage, the following shall be estimated: (i) Extent of loss of top soil due to widening and siting of construction activities (ii) Estimates of borrow area requirements and (iii) Area requirement for topsoil conservation. The bid document shall include provisions that necessitate the removal and conservation of topsoil at all locations opened up for construction by the Contractor.

## 6.3 Pre-construction Stage

6.3.1 The arrangements for temporary usage of land, borrowing of earth and materials by the Contractor with the land owner/Gram Panchayat shall include the conservation / preservation of topsoil.

## 6.4 Construction Stage

6.4.1 It shall be the responsibility of the Contractor to strip the topsoil at all locations opened up for construction. The stripped topsoil should be carefully stockpiled at suitable accessible locations approved by the PIU. At least 10% of the temporarily acquired area shall be earmarked for storing topsoil. In case of hilly and desert areas, topsoil with humus wherever encountered while opening up the site for construction shall be stripped and stockpiled.

### Locate stockpiles in ...

- # A secure area away from
  - Grade, Subsoil & Overburden materials;
  - Pit activities; and
  - Day-to-day operations.
- # Areas that do not interfere with future pit expansion and
- # Areas away from drainage paths and uphill of sediment barriers.

6.4.2 The stockpiles for storing the topsoil shall be designed such that the slope does not exceed 1:2 (vertical to horizontal), and the height of the pile is restricted to 2m. A minimum distance of 1m is required between stockpiles of different materials.

6.4.3 In cases where the topsoil has to be preserved for more than a month, the stockpile is to be stabilised within 7 days of forming. The stabilisation shall be carried out through temporary seeding. It consists of planting rapid-growing annual grasses or small grains, to provide initial, temporary cover for erosion control.

<b>Vegetative material for stockpile stabilisation...</b>	
⚡	Must consist of grasses, legumes, herbaceous, or woody plants or a mixture thereof
⚡	Selection & use of vegetative cover to take into account soil and site characteristics such as drainage, pH, nutrient availability, and climate to ensure permanent growth

6.4.4 After spreading the topsoil on disturbed areas, it must be ensured that topsoil is seeded, and mulched within 30 days of final grading.

6.4.5 During construction, if erosion occurs from stockpiles due to their location in small drainage paths, the sediment-laden runoff should be prevented from entering nearby watercourses.

<b>Preserving stockpiles – Precautions</b>	
⚡	Stockpiles will not be surcharged or otherwise loaded and multiple handling will be kept to a minimum to ensure that no compaction will occur.
⚡	Divert runoff around stockpiles unavoidably located in drainage paths using a perimeter bank uphill.
⚡	The stockpiles shall be covered with gunny bags or tarpaulin immediately in case they are not stored for periods longer than 1 month

6.4.6 Preservation of Stockpiles: The Contractor shall preserve the stockpile material for later use on slopes or shoulders as instructed by the Engineer.

## 6.5 Post Construction Stage

6.5.1 The topsoil shall be re-laid on the area after taking the borrow earth to maintain fertility of the agricultural field, finishing it to the required levels and satisfaction of the farmer.

6.5.2 The area to be covered with vegetation shall be prepared to the required levels and slope as detailed in the DPR. The stockpile material shall be spread evenly to a depth of 5-15cm to the designed slopes and watering the same as required. The growth of the vegetation shall be monitored at frequent intervals.

6.5.3 All temporary arrangements made for stockpile preservation and erosion control are to be removed after reusing the stockpile material.

# ECoP-7.0 Quarry Management

## 7.1 General

7.1.1 This code of practice pertains to the measures to address environmental concerns in quarries. The general practice adopted is to procure materials from existing quarries operating with the requisite permits. Scope of this ECoP extends to management measures in the event of the Contractor starting up new quarries<sup>4</sup> for extraction of material for this project only. **Table 7-1** presents the activities to be addressed during quarry operations and the significance of impacts in the project regions.

**Table 7-1 Significance of Impacts across Project Region**

Stages	Key Activities	Significance of Impacts							
		Rajasthan		Himachal		Uttar Pradesh		Jharkhand	
		Arid	Other areas	Low hills	High hills	Flood plains	Other areas	Hills	Plateau
Pre-construction	Establish new quarry								
Construction	Precautions during quarry operations								
Post-Construction	Implementation of Redevelopment Plan								
	Impacts not likely to be significant								
	Impacts likely to be significant								

## 7.2 Project Planning and Design Stage

7.2.1 The PIU shall provide in the DPR, a list of licensed quarries operating within the district and adjoining districts. In addition, the DPR shall contain the following: (i) Lead from the various existing quarries and (ii) Adequacy of materials for the project in these quarries.

7.2.2 Only in the event of non-availability of existing quarries, shall the Contractor open a new quarry in accordance with Mines and Minerals (Development & Regulation) Act, 1957. The bid document shall include the exhaust quarry redevelopment as per needs of the landowner / community.

## 7.3 Pre-construction Stage

7.3.1 The Contractor shall select an licensed quarry for procuring materials. The Contractor shall establish a new quarry only with the prior consent of the PIU only in cases when: (i) Lead from existing quarries is uneconomical and (ii) Alternative material sources are not available. The Contractor shall prepare a Redevelopment Plan for the quarry site and get it approved by the PIU.

7.3.2 The construction schedule and operations plans to be submitted to the PIU prior to commencement of work shall contain a detailed work plan for procuring materials that includes procurement, transportation and storage of quarry materials.

<sup>4</sup> The management of environmental concerns in the existing quarries or the redevelopment of exhausted quarries is outside the purview of the Contractor's scope. This is due to: (i) SPCBs are the nodal agencies for ensuring the quality of air and water, and (ii) The mandate for the monitoring of redevelopment of exhausted quarries is vested with the Government agency issuing permits. Therefore, the quarry operator is not bound to adhere to any additional environmental requirements laid down by the project for the entire quarry operations, as the project is one of the many users of the quarry.

<b>Operations &amp; redevelopment plan (if a new quarry is opened)....</b>
<ul style="list-style-type: none"> <li>⌘ Photograph of the quarry site prior to commencement.</li> <li>⌘ The quarry boundaries as well as location of the materials deposits, working equipments, stockpiling, access roads and final shape of the pit.</li> <li>⌘ Drainage and erosion control measures at site.</li> <li>⌘ Safety Measures during quarry operation.</li> <li>⌘ Design for redevelopment of exhaust site.</li> </ul> <p><b>Option A: Revegetating the quarry to merge with surrounding landscape:</b> This is done by conserving and reapplying the topsoil for the vegetative growth</p> <p><b>Option B: Developing exhausted quarries as water bodies:</b> The pit shall be reshaped and developed into pond, for harvesting rainwater. This option shall only be considered where the location of quarry is at the lowest point, i.e. surrounding areas / natural drainage slopes towards it.</p>

## **7.4 Construction Stage**

7.4.1 Development of site: To minimize the adverse impact during excavation of material following measures are need to be undertaken:

- i) Adequate drainage system shall be provided to prevent the flooding of the excavated area
- ii) At the stockpiling locations, the Contractor shall construct sediment barriers to prevent the erosion of excavated material due to runoff.
- iii) Construction of offices, laboratory, workshop and rest places shall be done in the up-wind of the plant to minimize the adverse impact due to dust and noise.
- iv) The access road to the plant shall be constructed taking into consideration location of units and also slope of the ground to regulate the vehicle movement within the plant.
- v) Incase of storage of blasting material, all precautions shall be taken as per The Explosive Rules, 1983.

7.4.2 Quarry operations including safety:

- i) Overburden shall be removed and disposed as per **ECoP-10.0**, “Waste Management”.
- ii) During excavation, slopes shall be flatter than 20 degrees to prevent their sliding. Incases where quarry strata are good and where chances of sliding are less this restriction can be ignored.
- iii) Incase of blasting, the procedure and safety measures shall be taken as per The Explosive Rules, 1983
- iv) The Contractor shall ensure that all workers related safety measures shall be done as per **ECoP-14.0**, “Public & Workers Health & Safety”.
- v) The Contractor shall ensure maintenance of crushers regularly as per manufacturer’s recommendation.

7.4.3 Stockpiling of the excavated material shall be done as per stockpiling of topsoil explained in **ECoP-6.0**, “Topsoil Salvage, Storage & Replacement.”

7.4.4 During transportation of the material, measures shall be taken as per **ECoP-13.0**, “Construction Plants and Equipment Management” to minimize the generation of dust and to prevent accidents

7.4.5 The PIU and the Technical Examiner shall review the quarry site for the management measures during quarry operation, including the compliance to pollution norms.

## **7.5 Post Construction Stage:**

7.5.1 The Contractor shall restore all haul roads constructed for transporting the material from the quarries to construction site to their original state.

7.5.2 The PIU and the Technical Examiner shall be entrusted the responsibility of reviewing the quarry site for the progress of implementation of Redevelopment Plan. These shall include the following two cases:

- ⌘ Redevelopment of quarries opened by the Contractor for the project
- ⌘ Redevelopment of existing quarries operated by other agencies

7.5.3 In the first case, the Contractor shall be responsible for the Redevelopment Plan prior to completion after five years, during the defect liability period. The PIU shall be responsible for reviewing this case of redevelopment prior to the issuing the defect liability certificate

7.5.4 In the second case, the redevelopment of exhaust quarry shall be the responsibility of the agency providing the permit to ensure the implementation of Redevelopment Plan.

# ECOP-8.0 Water for Construction

## 8.1 General

8.1.1 The terms and conditions of this Code of Practice pertain to the procurement of water required for construction. Except bituminous works, water is required during all stages of road construction such as Embankment Sub-Grade; Granular sub-base (GSB) and Water Bound Macadam (WBM). The activities requiring addressal during the project stages and the significance of impacts in the project regions are presented in **Table 8.1**.

**Table 8-1: Significance of impacts across project regions**

Stages	Key activities	Significance of impacts							
		Rajasthan		Himachal		Uttar Pradesh		Jharkhand	
		Arid	Other areas	Low hills	High hills	Flood plains	Other areas	Hills	Plateau
Project Planning & Design Stage	Scheduling construction to suit water availability								
	Identification of alternate water sources								
Pre-construction Stage	Arrangements for procuring water								
Construction	Extraction of water								
	Impacts not likely to be significant								
	Impacts likely to be significant								

## 8.2 Project Planning & Design Stage

8.2.1 The Detailed Project Report shall contain the following information:

- ⌘ Estimate of water requirement during different seasons based on construction schedule of various stages of the project,
- ⌘ Identification of potential sources of water for construction,
- ⌘ Arrangements to be worked out by the contractor with individual owners, when water is obtained from private sources,
- ⌘ Permits required for opening up new sources, as per the requirements of the existing statutory provisions, and
- ⌘ Whether scarcity of water would have any impact on schedule of construction.

### **In water-scarce regions, provide the following additional information in DPR...**

- ⌘ Exploring possibilities for use of existing perennial sources, through interactions with water user groups as the villagers, relevant Panchayat Raj Institutions (PRIs) and the Government Department, keeping in view that the water extraction does not infringe upon the usufruct rights of the existing water users.
- ⌘ Identification of potable water source for domestic use of workers and for use in cement - based construction such as cement concrete roads, culverts and other cross drainage works.
- ⌘ Identification of alternate water sources, water-harvesting techniques will be explored for use in hilly areas as Himachal Pradesh and Chota Nagpur hills of Jharkhand to avoid water extraction from the existing community sources.

8.2.2 In water scarce regions, if water-harvesting structures are to be constructed, suitable locations and mechanism for siting these structures will be identified. These are envisaged to be permanent water tanks for collection of stream water. Detailed drawings of water harvesting structures based on site conditions will need to be worked out and presented in the DPR. No extra payment shall be generally made for these works and the Contractor has to include the cost of these items in his offer while quoting his tendered rate.

8.2.3 Scheduling Construction in Water Scarce Areas: As part of the project preparation, PIU shall conduct an assessment of water requirement and availability in water scarce regions as: arid region of Rajasthan, Chota Nagpur Hills of Jharkhand and S W Plains of Uttar Pradesh. As far as possible, schedule for construction in these water scarce areas shall be prepared such that earthwork for embankment is carried out just before monsoon, so that water requirement for subsequent construction works such as granular sub-base and water bound macadam are met in monsoon and post monsoon season. Carrying out these activities even during the monsoon is possible as the rainfall may not be high enough to disrupt construction.

### 8.3 Pre-construction stage

8.3.1 Prior to commencement of extraction of water for construction, the contractor shall work out arrangements as specified in the DPR.

<b>Arrangements for procuring water by contractor...</b>	
#	<b>In case of community water sources</b> , the Contractor will carry out consultations and obtain written consent of Gram Panchayat for extraction of water through written arrangements with the PRI towards the same. Format of the Letter of Consent is presented in <b>Annexure 8-1</b> .
#	<b>In case of private water sources</b> , the Contractor shall not commence procurement of water from a source unless and until the written consent of owners of the parcel or parcels on which the source is located has been obtained.
#	<b>In case of new tube-wells</b> , the Contractor shall obtain clearances required from the Ground Water Board as required. The siting of such tube-wells shall be at a distance of not less than 20m from any septic tank/soak pit or other source of pollution.
#	<b>In case of water harvesting structures</b> (if required), the Contractor shall in consultation with the residents, identify suitable locations for siting the structure and construct the same.
#	<b>In case of perennial sources</b> , the Contractor shall adhere to all administrative procedures pertaining to procurement of water from such sources.

### 8.4 Construction Stage

8.4.1 During construction, the Contractor shall be responsible to monitor the following:

The arrangements worked out with the PRI/individual land owners for water extraction is adhered to,

- # Extraction of water is restricted to construction requirement and domestic use of construction workers
- # Water requirement for curing of concrete shall be minimized by pooling of water over the concrete or by covering with wet gunny bags
- # Water used for mixing of mortar/concrete and subsequent curing is free from injurious amount of oil, acids, alkalis, salts, sugar, organic materials or other substances that may be deleterious to concrete or steel and this water should conform to Clause 1010 of MoRT&H “Specifications for Road and Bridge works – Fourth Revision” and IS: 456, and,
- # The potable water used for drinking purposes of construction workers shall be as per the Indian Standard for Drinking Water IS: 10500, 1991.

8.4.2 Prior to issuing project completion certificate to the contractor, the PIU shall verify that the premises of water extraction points are restored to their original status after construction.

# ECoP-9.0 Slope Stability and Erosion Control

## 9.1 General

9.1.1 Stability of slopes is a major concern in hill areas and locations of high embankment. In cases of high embankment, water retention at the embankment base initially causes toe failure and subsequently failure of the whole embankment. Soil erosion is consequent to high runoff on hill slopes. High wind velocities cause erosion of embankments made up of cohesion-less sandy soils in western region of Rajasthan. Embankments made up of silty and sandy soils are eroded, in the absence of vegetative cover, when the slopes are steep say more than 20 Degree.

9.1.2 The scope of this ECoP includes measures to minimize the adverse environmental impacts on slope stability and soil erosion due to the construction of roads. The adverse environmental impact can be: (i) damage to adjacent land, (ii) silting of ponds and lakes disturbing the aquatic habitat (iii) erosion of rich and top fertile top layer of soil (iv) contamination of surface water bodies and (v) reduction in road formation width due to erosion of shoulders/berms. **Table 9-1** highlights the key activities that need to be addressed during the project stage and also the significance of impacts in different regions.

**Table 9-1 Significance of Impacts Across Project Region**

Stages	Key Activities	Significance of Impacts							
		Rajasthan		Himachal		Uttar Pradesh		Jharkhand	
		Arid	Other areas	Low hills	High hills	Flood plains	Other areas	Hills	Plateau
Project Planning & Design Stage	Slope considerations								
	Erosion considerations								
During Construction	Erosion Control Measures								
Post-Construction	Slope Stabilisation								
	Impacts not likely to be significant								
	Impacts likely to be significant								

## 9.2 Project Planning and Design Stage

9.2.1 During the detailed project preparation phase, the following investigations shall be carried out prior to finalisation of alignment.

- (a) Topographical
- (b) Hydrological
- (c) Geo-technical and
- (d) Geological Investigation (in case of hill roads)

9.2.2 The rock profile and geologically critical sections in Himachal are identified based on the satellite imagery for the state. Map of the critical areas shall be notified to the districts in HP to provide a broad profile.

9.2.3 Slope stability analysis for retaining / breast walls of height greater than 5m shall be carried out in hilly areas. The stability analysis shall be as per IRC: SP-48: 1998. Based on these investigations slope stabilisation measures are to be incorporated for finalising the alignment design.

- 9.2.4 In addition to the slope stability analysis the alignment should be such that (i) Steep as well as heavy cuts are avoided, (ii) Flora and fauna of the area are disturbed to a minimum possible extent and (iii) Natural drainage pattern is not unduly obstructed.
- 9.2.5 For high embankments, geo-technical investigations to determine of C,  $\lambda$ , density etc.) of the available material need to be conducted to check its suitability as fill material.
- 9.2.6 Following guidelines shall be followed in desert areas while using cohesion-less soils for embankment construction.
- ## The alignment should follow the natural ground level to the extent possible and the embankment shall be restricted to minimum to achieve ruling grades.
  - ## Slope of the embankment should be 3 (H): 1(V) or flatter.
  - ## The corners of the embankment may generally be rounded for the better aerodynamic performance

### 9.3 Pre-construction stage

9.3.1 Interceptor ditches are constructed in hill areas to protect the road bench and hillside slope from erosion due to heavy rainfall and runoff. Interceptor ditches are very effective in the areas of high intensity rainfall and where the slopes are exposed. These are the structures designed to intercept and carry surface run-off away from erodible areas and slopes, thus reducing the potential surface erosion. **Figure 9.1** shows typical installation of interceptor ditch structure as well as ditch lining types. The PIU must ensure that the layout and siting of ditches is as per guidelines on Road Drainage IRC:SP-42:1994.

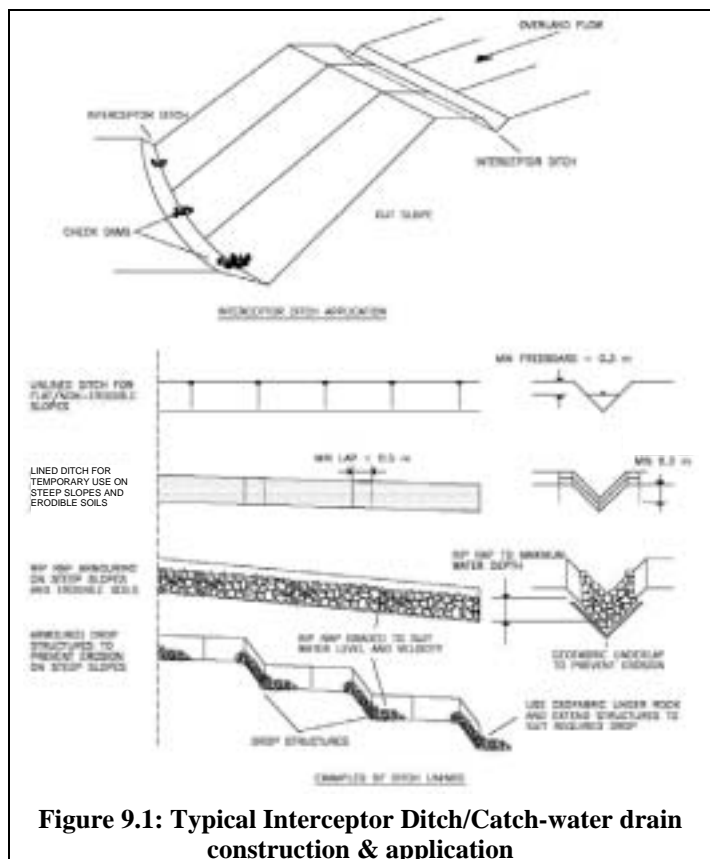

**Figure 9.1: Typical Interceptor Ditch/Catch-water drain construction & application**

### 9.4 Construction Stage

- 9.4.1 When alternative material such as fly ash is used for embankment formation, it needs to be ensured that sufficient filter bed is provided along with the top cap. All tests as per IS: 2720 (Parts: 4, 5, 8 & 40) and IRC: SP: 20-2002 are to be conducted on the embankment to keep a check on the compaction achieved.
- 9.4.2 Slope stabilisation techniques and erosion control measures as mentioned below are to be undertaken in hill areas.
- ## Increasing vegetation: On side slopes in hills, immediately after cutting is completed and debris is removed, vegetative growth has to be initiated by planting fast growing species of grass. This would prevent high velocities of runoff and resultant gully formation as well as pounding of water on the road bench. **Box 9-1** gives detailed specifications for provision of vegetation cover.

### Box 9-1: Detailed specifications for Vegetative cover

**Description:**

The vegetative cover should be planted in the region where the soil has the capacity to support the plantation and at locations where meteorological conditions favours vegetative growth.

**Site Preparation:**

☞ To prevent the seeds from being washed away subsequent to sowing, the area should be protected with surface roughening and diversions.

☞ Soil samples should be taken from the site and analysed for fertiliser and lime requirements.

**Seed Application:**

☞ The seed should be sown uniformly as soon as preparation of the seedbed has been completed.

☞ No seed should be sown during windy weather, or when the ground surface is wet, or when not tillable.

**Maintenance:**

During first six weeks, the planting should be inspected by the PIU, to check if the growth is uniform and dense. Appropriate moisture levels shall be maintained. There may be requirement of watering the plantings regularly during the dry seasons. Fertiliser and pest control applications may also be needed from time to time.

☞ **Sausage Walls / Gabions:** Sausage wall (commonly termed as Gabions) are being used extensively in hilly areas. The sausage wall are made by forming sausages of galvanized iron or steel wire netting of 4 mm dia having 10 cm square or hexagonal opening and filling the sausages with hard local boulders / stones and wrapping the wire net at the top. The sausage walls can withstand large deformation without cracking and are flexible. Further, due to the open structure, they allow free drainage of water. Typical arrangements with detailed specifications are shown in **Figure 9.2**. Sausage Walls shall be shall be constructed in-situ as per IRC: SP: 48-1998.

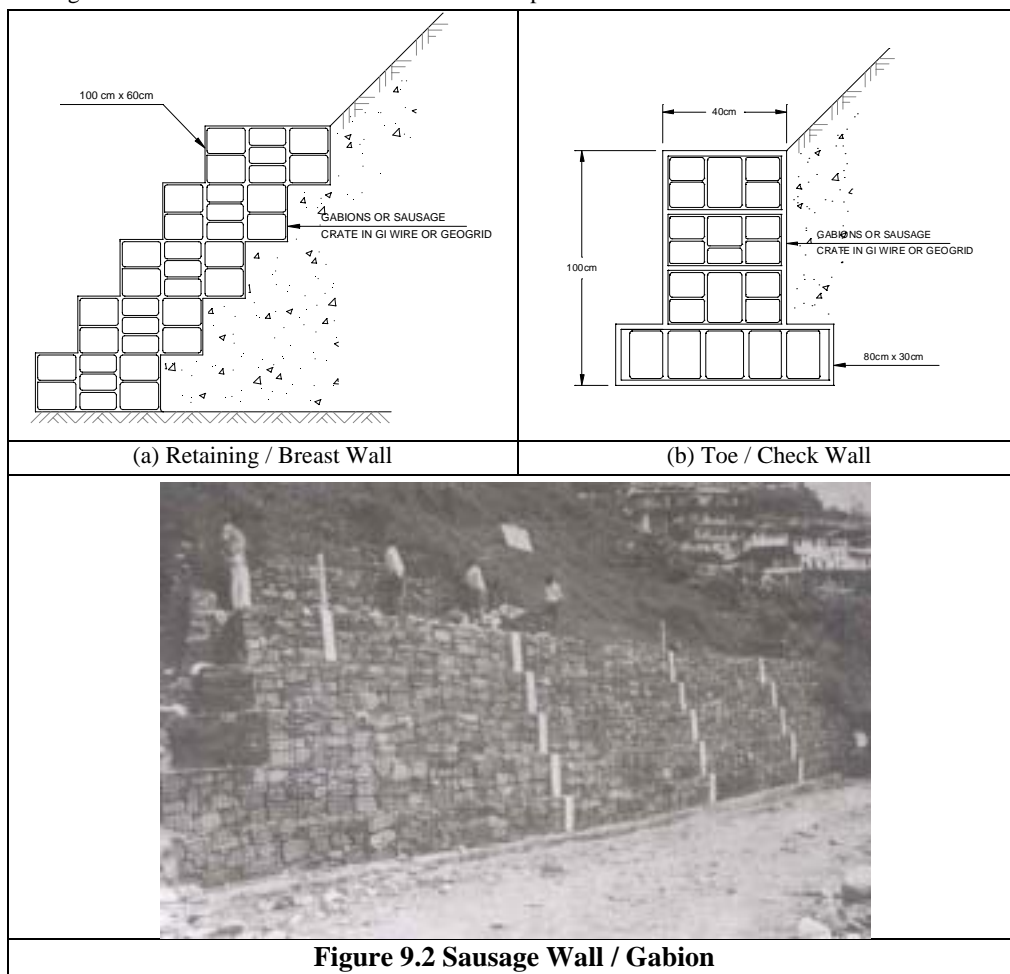

**Figure 9.2 Sausage Wall / Gabion**

☞ **Bally Benching:** To control the erosion on slopes as well as for arresting the shallow movement of top mantle slide mass at the construction location; the Contractor should provide Bally Benching. This method is also very effective in preventing gully erosion. Typical arrangements with detailed specifications are shown in **Figure 9.3**. Bally benching shall be installed as per IRC: SP: 48-1998.

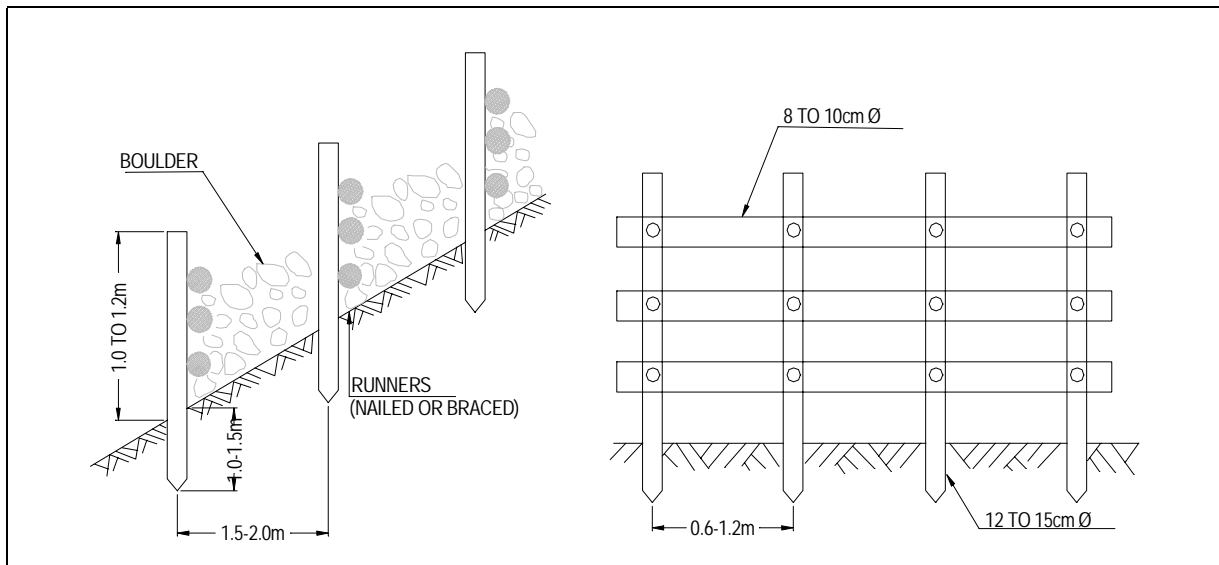

**Figure 9.3: Layout and Design Specification for Bally Benching**

- ☞ Check dams: Sheet and channel erosion on hill slopes gentler than 1(V):12(H) can be prevented effectively through construction of check dams. Details are provided in **Box 9-2**.

### Box 9-2: Check Dam

#### General:

A check dam is a small dam constructed in a drainage way to mitigate sheet and channel erosion by restricting the flow velocity. On steeper slopes greater than 1: 12 (H:V), check dams are not effective.

#### Basic Design Criteria:

- ☞ Check dams are usually constructed of riprap, logs, sandbags, and/or straw bales.
- ☞ The maximum check dam height should be 0.6 m.
- ☞ The centre of the check dam should be a minimum of 25 cm lower than the ends to act as a spillway for runoff, as illustrated in Figure 9.3
- ☞ Overflow areas should be stabilised to resist erosion.
- ☞ Stone check dams should use 7.5 cm or larger stone with side slopes of 2:1 (H:V) or flatter and should be keyed into the sides and bottom of the channel for a minimum depth of 0.6 m. The drainage area for a stone check dam should not exceed 0.2 Sq Km

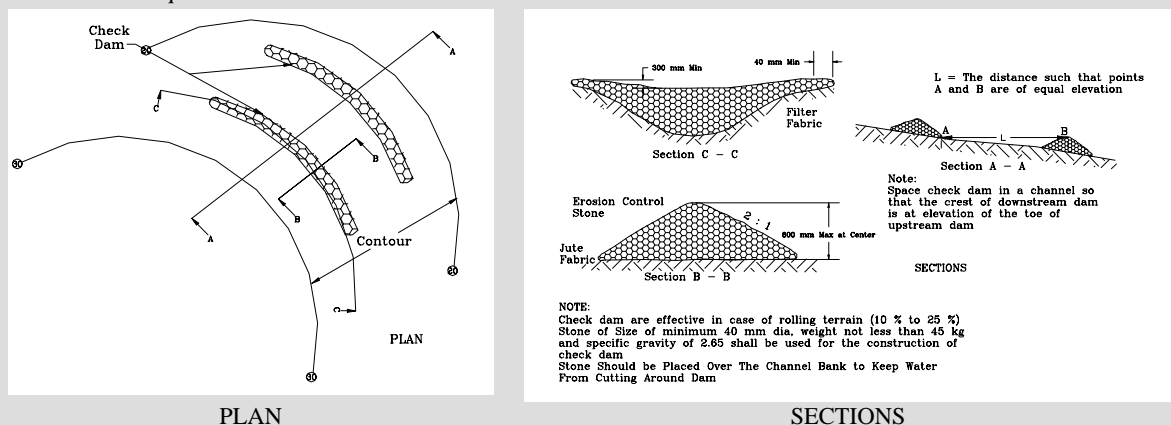

**Figure 9.4: Check Dam Specification**

- ☞ Multiple check dams should be spaced so that the bottom elevation of the upper dam is the same as the top elevation of the next dam downstream, as illustrated in **Figure 9.4** above.

#### 9.4.3 Soil erosion shall be controlled on high embankments by the following techniques:

- ☞ Silt Fencing (detailed specifications and drawings are provided in Box 9-3)
- ☞ In regions of intensive rainfall, locations of steep slopes, regions of high soil erosion potential and regions of short growing seasons, erosion control matting should be provided. Detailed specifications and drawings are provided in **Box 9-4**.
- ☞ Brush Barrier (detailed specifications and drawings are provided in Box 9-5)

### Box 9-3: Detailed Specifications for Silt Fencing

**Description:**

Silt fencing is a temporary sediment barrier made of woven, synthetic filter fabric supported by steel or wood post. The purpose of the silt fence is to prevent sediment carried by sheet flow from leaving the site and entering to natural drainage or any other water body located near the construction site. Silt fencing encourages the sheet flow and reduces the potential for development of rills and gullies. Care should be taken that silt fences are not installed across streams, ditches, waterways or other concentrated flow areas. All silt fencing should be installed along the contour, never up or down a slope. Where all the sheet flow run off is to be stored behind the silt fence, maximum slope length should not exceed as shown in the **Table 9-2**

**Table 9-2 Criteria For Silt Fence Placement**

Land Slope (%)	Maximum Slope Length (Above the fence in m)
< 2	30.0
2 to 5	22.5
5 to 10	15.0
10 to 20	7.5
> 20*	4.5

\* In areas where slope is greater than 20 %, a flat area length of 3.0 m between the toe of the slope and the fence should be provided

**Construction Specification:**

Silt fencing (Refer **Figure 9.5** for Cross-section) consists of 1.0 m wide filter fabric and should be placed on the contour. Incase runoff flow or velocities are very high or where slope exceed vertical height of 3.0 m, silt fencing should be wire reinforced as shown in the **Figure 9.5**. The contractor should purchase silt fencing in a continuous roll to the length of the barrier to avoid the use of joint. Incase of joints, filter cloth should be spliced together only at supporting post, with minimum 15 cm overlap and securely sealed. The pile is to be driven to a depth of 300 mm into the ground by pressing from the top. The frame will be installed at the edge of stockpiles and at the water bodies along which construction is in progress.

**Inspection:**

The PIU will inspect location as well as efficiency of silt fencing. The inspection should be done after every 15 days and incase of storm water, within 24 hours after the end of rain.

**Maintenance:**

The contractor should remove sediments, once they have accumulated to one-half the original height of the fence. Filter fabric should be replaced whenever it has deteriorated to such an extent that the efficacy of the fabric is reduced. Silt fence should remain in place until disturbed areas have been permanently stabilized. All the sediments accumulated should be properly disposed of before the fence is removed. The operation of removing and disposing have to be monitored by the PIU.

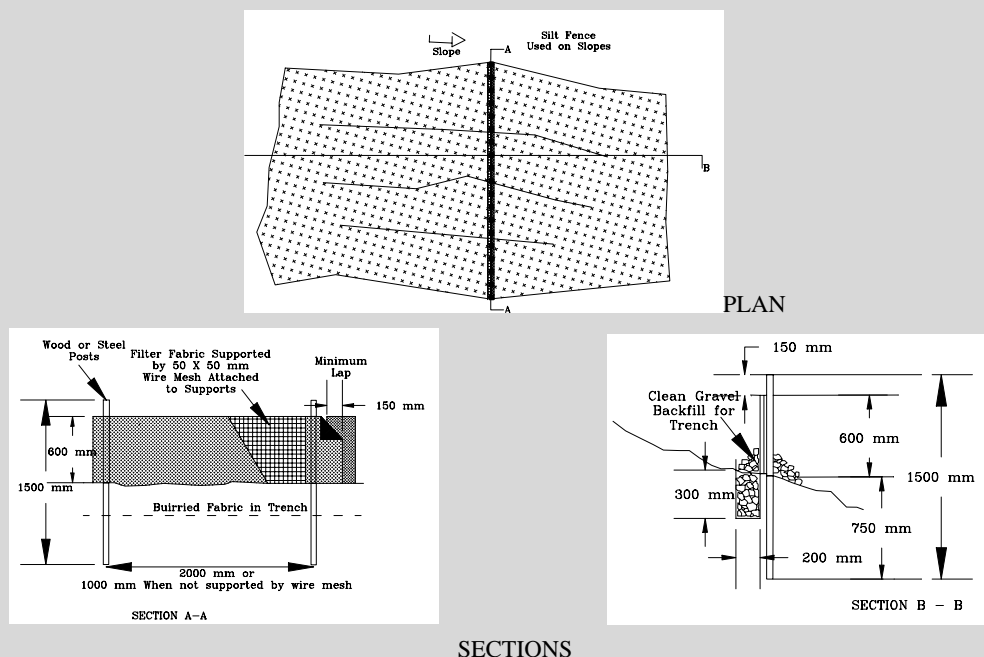

**Figure 9.5 Cross-section of Silt Fencing**

### BOX 9-4: Erosion Control Matting

#### Description:

The design specifications as well as locations should be finalised during the Project Preparation Phase. During the execution period in post-construction stage, PIU must ensure that all the guidelines are to be followed as per specifications during the site preparation and installation of erosion control matting. Following are the steps need to be followed for the placing erosion control matting:

#### Site Preparation:

- # The areas should be fertilised and seeded.
- # A smooth surface free of depressions that allows water to collect or flow under matting is required.
- # The soil should be left with loose surface after seeding.
- # The material should be steel wire formed into “U” shape and should be 15 cm to 25 cm long.

#### Installation:

- # Filter fabric made of biodegradable material (eg. Jute) should be placed horizontally on the slope less than 2:1
- # Prior to netting, a 10 cm anchor trench should be dug at the top and toe of the slope with the top trench placed 30 cm back from the crown, or a berm over which the fabric can be carried.
- # For horizontal application, work must proceed from the bottom towards the top of the slope with a 10 cm overlap. Cutting material should be folded less than 7.5 cm to 10 cm at the end, stapled and covered.
- # Staples should be placed at a spacing of 22.5 cm to 30 cm apart in the trenches along the horizontal lap joints.

### BOX 9-5: Detailed Specification for Brush Barrier

#### Description:

A brush barrier is a temporary barrier used to control sediment transport by using the residue materials available from clearing and grubbing. (Figure 9.6)

#### Design and Construction Criteria:

- # Brush should be cut and windrowed approximately 3 m from the toe of the slope. The brush barrier should be packed densely and should be a minimum of 1.2 m high before compressing. This may be accomplished during clearing and grubbing by having equipment push the brush, tree trimmings, shrubs, stones, root mats, and other materials into a mounded row on the contour. Logs placed within the barrier, parallel to the toe, can help reduce failures.
- # A brush barrier may be compressed by running a bulldozer along the top of the windrow. The compressed barrier should be 0.9 m to 1.5 m high and 1.5 m to 3.0 m wide. The top of the barrier should be at least 1.5 m below the finished roadway
- # A brush barrier may be left in place after construction unless it is in an aesthetically sensitive area or it is indicated otherwise on plans.

#### Maintenance:

Inspect a brush barrier after each rainfall and make necessary repairs. Sediment deposits should be removed when they reach approximately half the barrier's height.

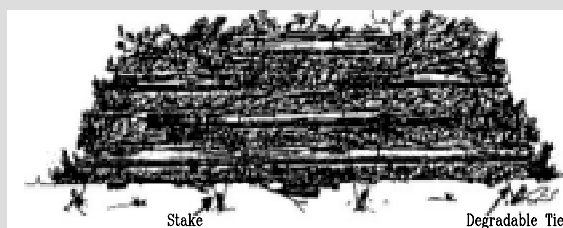

Front Elevation

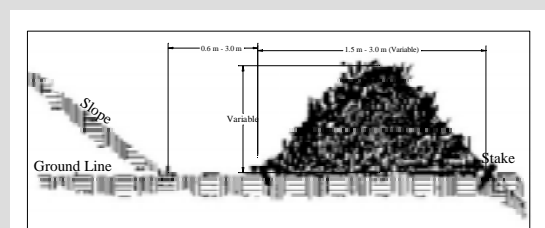

Side Elevation

Figure 9.6 Brush Barrier (Tree & Residual Material With Diameter > 150 Mm)

## 9.5 Post Construction Stage

- 9.5.1 All the exposed slopes shall preferably be covered with vegetation using grasses, brushes etc. Locally available species possessing the properties of (i) good growth (ii) dense ground cover and (iii) deep root shall be used for stabilization.
- 9.5.2 In case of steep and bare slopes requiring stabilization, in order to retain the seedling to the ground, asphalt mulch treatment may be given. Seedling are covered with asphalt emulsion and spread into a thin layer. The asphalt film gradually disintegrates and a carpet of green vegetation

and deep-rooted species of grass and clovers, takes its place. (*For details refer IRC: SP 48-1998, Chapter 11*)

- 9.5.3 Anchoring shall be carried out as per IRC: SP: 48-1998, Chapter 11 in case of rocks.
- 9.5.4 Regular inspection of check dams and repositioning/replacement of dislodged or stolen stones need to be carried out
- 9.5.5 Repair and maintenance of eroded side drain inverts is to be done in order to arrest retrogradation of levels in side drains. Slopes of high embankment can give a fertile base for growth of vegetative cover / sodding.
- 9.5.6 In arid areas, in order to avoid the deposition of sand over or near the road surface, shrubs if planted shall be at an appropriate distance from the formation. The shrubs should not be abutting the road and the distance for carrying out plantation shall be determined based on prevalent wind speeds as well as quantity of sand being carried amongst various other factors. There should be a clear gap between the roadway and shrubs to allow the wind to pickup its velocity and carry along with it any sand that is deposited



# ECoP-10.0 Waste Management

## 10.1 General

10.1.1 This code of practice describes procedures for handling, reuse and disposal of waste materials during construction. The waste materials generated can be classified into (i) Construction Waste and (ii) Domestic waste. The key activities during project stages where management of wastes is required and the significance of the impacts in the project regions are presented in **Table 10-1**.

**Table 10-1: Significance of Impacts across Project Regions**

Stages	Activities	Significance of Impacts							
		Rajasthan		Himachal		Uttar Pradesh		Jharkhand	
		Arid	Other areas	Low hills	High hills	Flood plains	Other areas	Hills	Plateau
Project Planning & Design	Identification of type/ source of waste								
Pre-construction	Identification of disposal sites								
Construction	Reuse of wastes								
Post-Construction	Decommissioning								
	Impacts not likely to be significant								
	Impacts likely to be significant								

## 10.2 Project Planning and Design Stage

10.2.1 As part of DPR preparation, PIU shall carry out the following measures

- ## Finalize road design and alignment to minimize waste generation through balancing of cut and fill operations and minimizing excess cuts requiring disposal.
- ## Identify the type of wastes as well as sources of waste during construction and suggest options for possible reuse.
- ## In case debris generated from cutting in hill areas could not be reused, it may be disposed off properly. One of the suggestions is indicated in Figure 10-1. The figure indicates construction of gabion walls on valley side at ridge locations to form a trough for waste disposal. As the ridge locations usually have streams flowing through, length of pipe provided at the culvert should be extended to let runoff flow out of the disposal location. After filling up of the disposal site, it shall be grassed and suitably vegetated to prevent erosion of the disposed soil.

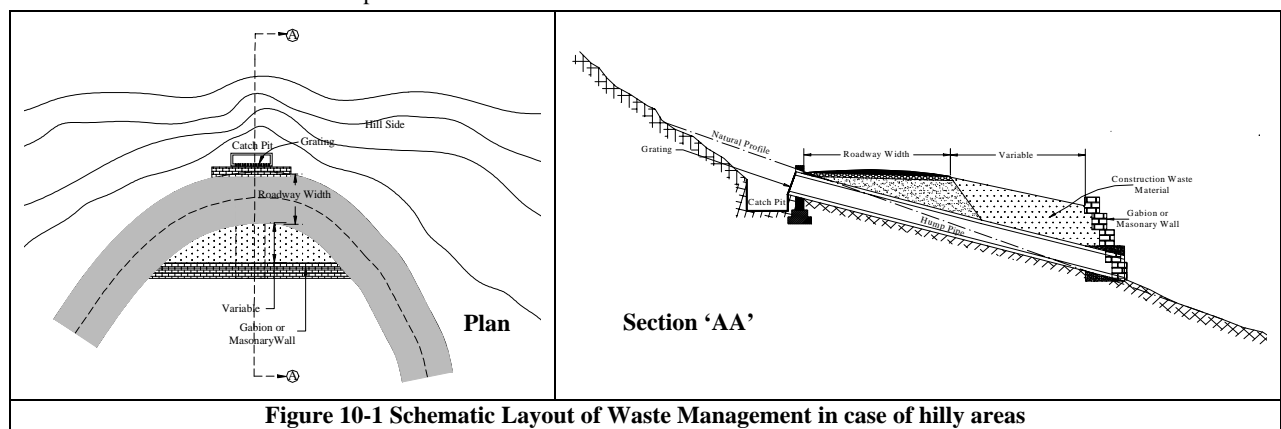

**Figure 10-1 Schematic Layout of Waste Management in case of hilly areas**

- ## Provide guidelines to the contractor for locating waste disposal sites for non-toxic wastes
- ## Identify existing landfill sites if available for disposal of toxic materials.
- ## In case no existing landfill sites are available, identification of landfill site as well as decommissioning of these site should be undertaken. Towards this, identify the clearance requirements.
- ## Include in the bid document under the Special Conditions of Contract, a clause stating that all provisions of Environmental Codes of Practice shall be applicable to the locations of disposal of wastes. These shall

include: **ECoP-6.0**, “Topsoil Salvage, Storage and Replacement”, **ECoP-9.0**, “Slope Stability and Erosion Control” and **ECoP-12.0**, “Drainage”.

### 10.3 Pre-construction Stage

10.3.1 The contractor shall identify the activities during construction, that have the potential to generate waste and work out measures for the same in the construction schedule to be submitted to the PIU. A sequential listing of the activities during road construction and the nature of wastes together with the possible options for reuse are specified in **Table 10-2**. For the disposal of excess cut and unsuitable (non-toxic) materials, the contractor shall identify the location for disposal in consultation with the community / Gram Panchayat. Any toxic materials shall be disposed in existing landfill sites that comply with legislative requirements. Prior to disposal of wastes onto private/community land, it shall be the responsibility of the Contractor to obtain a No-objection Certificate (NOC) from the land owner/community. The format for NOC shall be as per **Annexure 10-1**. The NOC shall be submitted to the PIU prior to commencement of disposal.

10.3.2 The Contractor shall educate his workforce on issues related to disposal of waste, the location of disposal site as well as the specific requirement for the management of these sites.

Practices to avoid – waste disposal ...	
⚡	Tipping of waste into stream channels, water bodies, forests and vegetated slopes
⚡	Non-cleaning of wastes after day’s work
⚡	Leaching of wastes
⚡	Littering in construction camps / sites
⚡	Storing wastes on private land

### 10.4 Construction Stage

10.4.1 The contractor shall either reuse or dispose the waste generated during construction depending upon the nature of waste, as specified in **Table 10-2**. The reuse of waste shall be carried out by the contractor only after carrying out the specific tests and ascertaining the quality of the waste materials used, and getting the same approved by the PIU.

10.4.2 Wastes that were not reused shall be disposed off safely by the contractor. The contractor shall adopt the following precautions while reusing wastes for construction:

- ⚡ In case of bituminous wastes, dumping will be carried out over a 60 mm thick layer of rammed clay so as to eliminate any chances of leaching.
- ⚡ In case of filling of low-lying areas with wastes, it needs to be ensured that the level matches with the surrounding areas. In this case care should be taken that these low lying areas are not used for rainwater storage
- ⚡ In case oil and grease are trapped for reuse in a lined pit, care shall be taken to ensure that the pit should be located at the lowest end of the site.

10.4.3 The waste management practices adopted by the Contractor, including the management of wastes at construction camps etc shall be reviewed by the PIU during the progress of construction.

### 10.5 Post Construction stage

10.5.1 After decommissioning of construction sites, the Contractor shall hand over the site after clearing the site of all debris/wastes to the PIU. The site shall be inspected by the PIU. In case of disposal of wastes on private land, certificate of Completion of Reclamation is to be obtained by the Contractor from the landowner that “the land is restored to his satisfaction” (**Annexure 5-1**). The same is to be submitted to the PIU before final payment is claimed.

**Table 10-2: Type of wastes and scope for reuse**

S.No	Activity	Type of waste	Scope for possible reuse	Disposal of waste
<b>I</b>	<b>CONSTRUCTION WASTES</b>			
1	Site Clearance and grubbing	Vegetative cover and top soil	Vegetating embankment slopes	
		Unsuitable material in embankment foundation	Embankment Fill	Low lying areas Land fill sites
2	Earthworks			
i	Overburden of borrow areas	Vegetative cover and soil	Vegetating embankment slopes	
ii	Overburden of quarries	Vegetative cover and soil	Vegetating embankment slopes	
		Granular material	Embankment Fill, Pitching	
iii	Accidental spillages during handling	Dust		
iv	Embankment construction	Soil and Granular Material	Embankment Fill	
v	Construction of earthen drains	Soil	Embankment Fill	
3	Concrete structures			
i	Storage of materials	Dust, Cement, Sand, Metal Scrap	Constructing temporary structure, embankment fill	
				Scrap Yard
ii	Handling of materials	Dust		
iii	Residual wastes	Organic matter	Manure, Revegetation	
		Cement, sand	Constructing temporary structure, embankment fill	
		Metal scrap	Diversion sign, Guard Rail	
4	Reconstruction works			
i	Dismantling of existing pavement	Bitumen Mix (broken to less than 75 mm size), granular material	Sub-base	
		Concrete	Road sub-base, reuse in concrete, fill material and as rip rap on roads	
		Guard rail sign post, guard stone	Reuse for same	
ii	Dismantling of cross drainage structures	Granular material & bricks	Constructing temporary structure, embankment fill	
		Metal scrap	Diversion sign, Guard Rail	
		Pipes	Culvert	
5	Decommissioning of sites			
i	Dismantling of temporary structures	Granular material and bricks	Constructing temporary structure, embankment fill	
6	Hill Roads			
	i) Hill cutting	Vegetative cover	Vegetating embankment slopes	
		Soil & granular material	Embankment Fill	
	ii) Clearance of slides	Vegetative cover	Vegetating embankment slopes	
		Soil & granular material	Embankment Fill	
7	Maintenance operations			
i	Desilting of side drains	Organic matter and soil	Revegetation	
<b>II</b>	<b>OIL AND FLUIDS</b>			
1	Construction machinery – maintenance and refueling	Oil and Grease	Incineration, Cooking, Illumination	
2	Bituminous works			
i	Storage	Bitumen	Low Grade Bitumen Mix	
		Bitumen	Low Grade Bitumen Mix	
ii	Mixing and handling	Bitumen Mix	Sub-base, Paving access & cross roads	
		Bitumen Mix	Sub-base, Paving access & cross roads	
iii	Rejected bituminous mix	Bitumen Mix	Sub-base, Paving access & cross roads	
<b>III</b>	<b>DOMESTIC WASTES</b>			
1	Construction camps	Organic waste,	Manure	
		Plastic and metal scrap		Scrap Yard
		Domestic effluent	Irrigation	



# ECoP-11.0 Water Bodies

## 11.1 General

11.1.1 Water bodies may be impacted when the road construction is adjacent to it or the runoff to the water body is affected by change of drainage pattern due to construction of embankment. The following activities are likely to have an adverse impact on the ecology of the area:

- ⊘ Earth moving
- ⊘ Removal of vegetation
- ⊘ Vehicle/Machine operation and maintenance
- ⊘ Handling and laying of asphalt and
- ⊘ Waste disposal from construction camps

### Construction near water bodies impairs ...

- ⊘ Catchment area of the water body
- ⊘ Drainage system
- ⊘ Flood level and water logging
- ⊘ Flora and fauna dependant on the water body
- ⊘ Ground water recharging
- ⊘ Animal husbandry as water bodies are used by animals
- ⊘ Water quality &
- ⊘ Runoff (increase/decrease)

11.1.2 **Table 11-1** highlights the key activities that need to be addressed during different stages of construction and also the significance of the impacts in project regions

**Table 11-1: Significance of Impacts across Project Region**

Stages	Key Activities	Significance of Impacts							
		Rajasthan		Himachal		Uttar Pradesh		Jharkhand	
		Arid	Other Areas	Low Hills	High Hills	Flood Plains	Other Areas	Hills	Plateau
Project Planning & Design	Alignment of Road								
Pre-construction	Mitigation designs in consultation with Community								
Construction Stage	Erosion control and Embankment Protection Measures								
	Impacts not likely to be significant								
	Impacts likely to be significant								

## 11.2 Project Planning and Design Stage

11.2.1 All efforts are to be taken to avoid the alignments passing adjacent or close to water bodies. Where possible, it should be realigned away from the water body without cutting its embankment, decreasing the storage area or impairing the catchment area. Adequate drainage arrangements as per IRC:SP-20:2002 have to be provided. Stream bank characteristics and hydrology of the area are to be studied before finalizing the alignment, the profile and cross-drainage structures.

11.2.2 If it is not possible to shift the alignment and the road is located on the banks of a drinking water pond, the camber shall be away from water body. The embankment slopes shall be protected from erosion by providing slope protection measures. A sample drawing of the measures suggested is presented as **Annexure 11-1**.

11.2.3 The decision on shifting the alignment or provision of erosion control measures on embankments cutting water bodies shall be taken by the PIU. However, it shall be ensured by the PIU that no adverse affect on the water body shall take place during construction stage.

- 11.2.4 The PIU after an assessment of the likely impacts on the water body and review of the provisions of this ECoP shall prepare Rehabilitation Plan for rectifying the likely impact due to the construction of PMGSY Road.
- 11.2.5 Complete filling of water body with soil is not contemplated in the project. The rehabilitation of water body should be with the objective of restoring it to its original state or to a better state with necessary enhancement of its environs.
- 11.2.6 Besides the following, the rehabilitation plan should include activities which are required as per statutory provisions applicable in the state:
- ## Reconstruction and stabilization of embankment in case it is impacted
  - ## If storage area is lost, then the water body is to be deepened / widened to regain an equivalent volume. Deepening of the pond is to be done when the pond is dry.
  - ## Locations of erosion protection works and silt fencing (as per **ECoP-9.0**, “Slope Stability & Erosion Control”, Box 9-3) to prevent sediment laden runoff caused by construction activities, entering the water body
  - ## Location of side drains (temporary or otherwise) to collect runoff from the embankment before entering the water body in accordance with IRC:SP-20:2002
  - ## Work program in relation to the anticipated season of flooding/overflowing of the water body
  - ## Obstructions likely to cause temporary flooding and information to seek clearance to remove the obstruction
  - ## Drawings indicating the landscape details along with species of trees / bushes to be planted in the surrounding environs of the water body
  - ## Costs of rehabilitation.
- 11.2.7 Concurrence of the Gram Panchayat has to be sought on the Rehabilitation Plan and community concerns, if any have to be incorporated into the plan by the PIU.
- 11.2.8 Cost estimates to mitigate impacts on water bodies through the rehabilitation plan or otherwise shall be incorporated into the DPR.

<b>Steps for addressal of impacts on water bodies in DPR ...</b>
<p>Step 1: Capture following details during Transect Walk:</p> <ul style="list-style-type: none"> <li>(i) Location of pond in relation to existing alignment.</li> <li>(ii) Approximate size and depth of the water body in meters ‘m’.</li> <li>(iii) Designated use of the water body – Household Use/Drinking/Irrigation.</li> <li>(iv) Visual inspection of the quality of water.</li> </ul> <p>Step 2: Consult people regarding alternate routes that were devised to avoid the pond. If alternate routes are not available, consent of the villagers is to be sought for affecting the pond and also the measures that would be taken to mitigate the impacts.</p> <p>Step 3: If impacting the pond, the extent of impact is to be clearly indicated on a separate drawing showing blown up portion of the pond.</p> <p>Step 4: Prepare rehabilitation plan if water body is getting adversely impacted.</p> <p>Step 5: Precautionary measures while working close to the water body are to be incorporated into the DPR</p>

### **11.3 Pre-construction stage**

- 11.3.1 The Rehabilitation Plan should be implemented by the Contractor immediately after completion of construction at the stretch near the water body
- 11.3.2 When there is interruption to regular activities of villagers near water body due to construction or rehabilitation work, following are the Contractor’s responsibilities:

<b>Working near Water Bodies – Precautions</b>
## Avoid locating roads on pond embankment
## Collect road runoff before entering the water bodies
## Runoff to be filtered of sediments before letting into water bodies
## Avoid debris disposal into water bodies
## Avoid disposal of oil/grease/other contaminants into water bodies

- ⊘# Restriction on use of water during construction, if any, should be intimated to the community in advance
- ⊘# Alternate access to the water body is to be provided in case there is interruption to use of exiting access. The access provided should be convenient for use of all the existing users whether community or cattle
- ⊘# If the water body affected is a drinking water source for a habitation, alternate sources of water are to be provided to the users during the period for which its use is affected

## **11.4 Construction Stage**

- 11.4.1 It should be ensured by the contractor that the runoff from construction site entering the water body is generally free from sediments
- 11.4.2 Silt fencing and/or brush barrier (as per details presented in **ECoP-9.0**, “Slope Stability & Erosion Control) as planned shall be installed in the drainage channels for collecting the sediments before letting them into the water body.
- 11.4.3 Silt/sediment should be collected and stockpiled for possible reuse as surfacing of slopes where they have to be revegetated
- 11.4.4 Cutting of embankment reduces the water retention capacity and also weakens it, hence:
  - ⊘# The contractor should ensure that the decrease in water retention should not lead to flooding of the construction site and surroundings causing submergence and interruption to construction activities.
  - ⊘# Any perceived risks of embankment failure and consequent loss/damage to the property shall be assessed and the contractor should undertake necessary precautions as provision of toe protection, erosion protection, sealing of cracks in embankments. Failure to do so and consequences arising out of embankment failure shall be the responsibility of the contractor. The PIU shall monitor regularly whether safe construction practices near water bodies are being followed.
- 11.4.5 Alternate drain inlets and outlets shall be provided in the event of closure of existing drainage channels of the water body
- 11.4.6 Movement of machinery and workforce shall be restricted around the water body, and no waste from construction camps or sites shall be disposed into it.

## **11.5 Post construction stage**

- 11.5.1 With the completion of construction, the PIU has to ensure implementation of rehabilitation plan for the water body, as planned.
- 11.5.2 The precincts of the water body have to be left clean and tidy with the completion of construction.
- 11.5.3 Drainage channels of adequate capacity shall be provided for the water body impacted.



## ECoP-12.0 Drainage

### 12.1 General

- 12.1.1 A road with good drainage is a good road. Inadequate and faulty drainage arrangements result in obstruction to natural drainage pattern. The problem is further aggravated in the low-lying areas and flood plains receiving high intensity rainfall, which can lead to the instability of embankment, damage to pavement, sinking of foundation, soil erosion, safety hazards and disruption in traffic. Provision of cross-drainage and longitudinal drainage increases the life of the road and consequently reduces water logging and related environmental impacts. The functioning of the drainage system is therefore a vital condition for a satisfactory road.
- 12.1.2 However, construction or upgradation of CD structures and longitudinal drains is likely to increase sediments, scour the banks, change water level and flow, and affect the ecology of the surrounding area.
- 12.1.3 The present code shall address the environmental concerns related to drainage aspects during different stages of the project execution. Engineering aspects brought out in this chapter are for sake of clarity. The design shall however be covered by relevant IRC codes / guidelines. Sub activities requiring incorporation during various stages of project implementation and their significance levels for drainage aspects are presented below in **Table 12-1**.

**Table 12-1 Significance of Impacts across Project Regions**

Stage	Key Activity	Rajasthan		Himachal		Uttar Pradesh		Jharkhand	
		Arid	Other areas	Low hills	High hills	Flood plains	Other areas	Hills	Plateau
Project planning & design	Hydrological Investigation								
	Geometric Design								
Pre-construction	Consultations with downstream and upstream users								
Construction	Sediment control measures								
Post-construction	Inspection and maintenance								
	Impacts not likely to be significant								
	Impacts likely to be significant								

### 12.2 Project Planning and Design

- 12.2.1 Drainage shall be broadly taken up as (i) Cross-Drainage and (ii) Longitudinal Drainage both surface & sub-surface drainage. The alignment shall be routed such that minimum drainage crossings are encountered. Also the geometric design criteria as per IRC:SP-20:2002, for effective surface drainage should be ensured.
- 12.2.2 All drains crossing the alignment shall be identified on site and marked on map while undertaking transect walk. Basic information on the width of channel, frequency of traffic holdup and flow would provide inputs into screening of alternate alignments as well as fixing the alignment. Consultations with the community shall provide information on the HFL in the area.
- 12.2.3 In areas of high and medium intensity rainfall (>400 mm/year), flood prone areas and hilly areas design of CD structures shall be prepared to avoid scouring on the downstream side and afflux on the upstream side. In areas where the Technical Audit identifies likely incidences of flooding/scouring, additional hydrological studies will need to be conducted and designs updated accordingly. For bridges and other drainage structures the studies shall be conducted as per *IRC: SP-13: 1973 "Guidelines for the Design of Small Bridges & Culverts"* and *IRC: SP-33:1989 "Guidelines on Supplemental Measures for Design, Detailing & Durability of Important Bridge Structures"*.

- 12.2.4 Design of cross-drainage structures shall be based on the inputs from the hydrological studies as per clause 12.2.3 and in other areas, the C-D structure design shall be as per IRC:SP-20:2002.
- 12.2.5 Design of C-D structure shall be such that:
- ⌘ Normal alignment of the road is followed even if it results in a skew construction of culverts and stream bank protection are incorporated
  - ⌘ Afflux generated is limited to 45 cm in plains with flat land slopes as it may cause flooding of upstream areas
  - ⌘ It is fish friendly – fish passage is not interrupted either in upstream or downstream direction
  - ⌘ Adequate openings are provided along with adequate scour protection measures for stream bank, roadway fill as head walls, wing walls and aprons as per provisions of IRC guidelines.
  - ⌘ Reinforced road bed (of concrete or rock) for protection against overflow in case of low water crossing (fords/causeways) is included
  - ⌘ The design of C-D structure should have steps leading to the bed of the drainage channel, for regular inspection of the sub-structure.
- 12.2.6 Schedule of construction of C-D structures should preferably be carried out during dry months to avoid contamination of streams
- 12.2.7 Longitudinal drains are to be designed to drain runoff from highest anticipated rainfall as per hydrological analysis in high rainfall areas (annual rainfall > 1000 mm) and hill areas (refer Appendix “Heaviest Rainfall in One Hour (mm) IRC:SP-13: 1998, “Guidelines for the Design of Small Bridges and Culverts” for rainfall data). For design of longitudinal drains in other areas, the design shall be as per IRC: SP-20: 2002.
- 12.2.8 Outfall of the roadside drains shall be into the nearby stream or culvert or existing depressions in the ground. The outfall should be at such a level that there would be no backflow into the roadside drain. Wherein pond/low lying areas exist in the vicinity, the flow, may be diverted into them for possible ground water recharge.
- 12.2.8.1 In case of Hilly areas, if no natural drainage system is found appropriate for roadside drain outfall, water-harvesting structures shall be considered to collect the runoff. The location shall be determined based on the size of the structure (which in turn depends on the discharge anticipated) imperviousness of the strata and willingness of the landowner who would be utilizing the collected water. These shall be determined by the PIU in consultation with the landowner during project preparation stage.
- 12.2.9 The roadside drains in high rainfall areas (annual rainfall > 1000mm) and hill areas, shall be stone lined to protect from runoff of high velocities.
- 12.2.10 In case of high embankment or bridge approaches, lined channels shall be provided to drain the surface runoff, prevent erosion from the slopes and avoid damage to shoulders and berms. Detailed specifications shall be in accordance with IRC SP 42:1992, Guidelines on Road Drainage and IRC: SP-20: 2002, Rural Road Manual.

### **12.3 Pre-Construction Stage**

- 12.3.1 Following measures are to be undertaken by the contractor prior to the commencement of CD/Bridge construction in case it effects the surface or sub surface flow through the stream / nallah:
- ⌘ The downstream as well as upstream user shall be informed one month in advance
  - ⌘ The contractor shall schedule the activities based on the nature of flow in the stream.
  - ⌘ The contractor should inform the concerned departments about the scheduling of work. This shall form part of the overall scheduling of the civil works to be approved by PIU.
  - ⌘ Erosion and sediment control devices if site conditions so warrant, are to be installed prior to the start of the civil works.

- ⊘# Interceptor drains to be dug prior to slope cutting to avoid high runoff from slopes entering construction sites in case of hill roads
- ⊘# Runoff from temporary drains and interceptor drains to be directed into natural drainage system in hill roads
- ⊘# In case of up-gradation of the existing CD Structures, temporary route / traffic control shall be made for the safe passage of the traffic, depending upon the nature of the stream and volume of traffic.
- ⊘# All the safety/warning signs are to be installed by the contractor before start of construction

12.3.2 In case of utilization of water from the stream, for the construction of the CD structures, the contractor has to take the consent from the concerned department (refer **ECoP-8.0**, “Water for Construction”)

## **12.4 Construction Phase**

- 12.4.1 Drainage structures at construction site shall be provided at the earliest to ensure proper compaction at the bridge approach and at the junction of bridge span and bridge approach.
- 12.4.2 In hill areas sub-surface drains, if required, shall be provided immediately after cutting the slopes and forming the roadbed (sub grade).
- 12.4.3 Velocity of runoff to be controlled to avoid formation of rills/gullies as per **ECoP-9.0**, “Slope stability & erosion control”
- 12.4.4 While working on drainage channels, sediment control measures if required shall be provided. In such case Silt fencing / brush barrier (as per the detailed specifications given in Box 9-3 and 9-5 respectively of **ECoP-9.0**, “Slope Stability & Erosion Control”) shall be provided across the stream that carries sediment.
- 12.4.5 The sediments collected behind the bunds shall be removed and after drying, can either be reused or disposed off as per **ECoP-10.0**, “Waste Management”
- 12.4.6 Safety devises and flood warning signs to be erected while working over streams and canals

## **12.5 Post Construction**

- 12.5.1 Inspection and cleaning of drain shall be done regularly to remove any debris or vegetative growth that may interrupt the flow.
- 12.5.2 HFL should be marked as per hydrological data on all drainage structures
- 12.5.3 Temporary structures constructed during construction shall be removed before handing over to ensure free flow through the channels.
- 12.5.4 The piers and abutments should be examined for excessive scour and make good the same if required.
- 12.5.5 In case of Causeway, following aspects shall be taken into consideration:
- ⊘# Dislocation of stones in stone set pavements, scouring of filler material due to eddy currents.
  - ⊘# Floating debris block the vents. Incase of large amount of floating material, debris arrestor shall be provided in upstream side.
  - ⊘# Damage to guide stones, information boards shall be inspected and replaced accordingly.
- 12.5.6 Schedule of Inspection shall be drawup for checking cracks, settlements and unusual backpressures. It must be ensured that all the rectification shall be undertaken as and when required. Following are broadly the items to be checked:
- ⊘# Settlement of piers/abutments & settlement of approach slabs have to be checked
  - ⊘# Cracks in C-D structures or RCC slabs
  - ⊘# Drainage from shoulders to be ensured
  - ⊘# Ditches & drains to be kept clean of debris or vegetation growth
  - ⊘# Repairs to parapet of culverts whenever required are to be undertaken



## ECoP-13.0 Construction Plants & Equipment management

### 13.1 General

13.1.1 During execution of the project, construction equipments, machinery and plants always have impact on the environment. The impact can be due to the gaseous emissions, dust, noise and oil spills that concern the safety and health of the workers, surrounding settlements and environment as a whole. This code of practice describes the activities during the project stages where pollution control measures are required. **Table 13-1** highlights the key activities that need to be addressed during the project and the significance of impacts in the project region.

**Table 13-1: Significance of Impacts Across Project Regions**

Stages	Key Activities	Significance of Impacts							
		Rajasthan		Himachal		Uttar Pradesh		Jharkhand	
		Arid	Other areas	Low hills	High hills	Flood plains	Other areas	Hills	Plateau
Project Planning & Design Stage	Equipment Selection								
Pre-construction Stage	Awareness of Safety Among Workers								
Construction Stage	Safety devices & Cautionary Signs								
	Waste Disposal								
Post-construction Stage	Restoration of Plant Site / Haul Roads								
	Impacts not likely to be significant								
	Impacts likely to be significant								

### 13.2 Project Planning and Design Stage

- 13.2.1 Selection criteria for setting up a plant area and parking lot for equipments and vehicles shall be done as per siting criteria for construction camp specified in **ECoP-3.0**, “Construction Camps”
- 13.2.2 Section 4, Part –I General Condition of Contract specified in Standard Bidding Document for Pradhan Mantri Gram Sadak Yojana (PMGSY) shall be adhered to during the preparation of bidding document.

### 13.3 Pre-construction Stage

- 13.3.1 The Contractor must educate the workers to undertake safety precaution while working at the plant / site as well as around heavy equipments as per Clause 14.3.2, Section 14.3, **ECoP-14.0**, “Public and Worker’s Health & Safety”.
- 13.3.2 Before setting up the crusher and hot-mix plant the contractor shall acquire “Consents” from the State Pollution Control Board as per Air (Prevention and Control of Pollution) Act, 1981, Chapter IV, Section 21.
- 13.3.3 The Contractor must ensure that all machinery, equipments, and vehicles shall comply with the existing Central Pollution Control Board (CPCB) noise and emission norms as applicable.
- 13.3.4 The PIU must ensure that the Contractor shall submit a copy of the approvals and PUC Certificates as applicable before the start of relevant work.

## 13.4 Construction Stage

13.4.1 The Contractor shall undertake measures as per **Table 13-2** to minimize -the dust generation, emissions, noise, oil spills, residual waste and accidents at the plant site as well as during transportation of material to construction site.

**Table 13-2: Measures at Plant Site**

Concern	Causes	Measures
Dust Generation	Vehicle Movement	<ul style="list-style-type: none"> <li>⊘ Water sprinkling</li> <li>⊘ Fine Materials shall be Transported in Bags or Covered by Tarpaulin during Transportation</li> <li>⊘ Tail board shall be properly closed and sealed</li> </ul>
	Crushers	⊘ Water Sprinkling
	Concrete-Mix Plant	⊘ Educate the workers for following good practices while material handling
Emissions	Hot-Mix Plant	<ul style="list-style-type: none"> <li>⊘ Site Selection as per Clause 6.5.2, Section 6.5, IRC's Manual for Construction &amp; Supervision of Bitumen Work</li> <li>⊘ Regular maintenance of Dust Collector as per manufacture's recommendations</li> </ul>
	Vehicles	⊘ Regular maintenance as per manufacture's recommendation
	Generators	⊘ Exhaust vent of long length
Noise	Heavy Load Vehicles	⊘ Exhaust silencer, Regular maintenance as per manufacture schedule
	Crushers	⊘ Siting as per <b>ECoP-3.0</b> , "Construction Camps"
	Generators	⊘ Shall be kept in a room that is acoustically enclosed (for generators of 5 KVA or above). <sup>5</sup> There shall be regular maintenance as per manufacture's recommendation.
Oil Spills	Storage and Handling	<ul style="list-style-type: none"> <li>⊘ Good practice,</li> <li>⊘ <b>ECoP-10.0</b>, "Waste Management"</li> </ul>
Residual waste	Dust Collector and Pits	⊘ <b>ECoP-10.0</b> , "Waste Management"
Concrete waste	Concrete-Mix plant	⊘ <b>ECoP-10.0</b> , "Waste Management"
Bitumen and bitumen mix	Hot-mix Plant	⊘ <b>ECoP-10.0</b> , "Waste Management"
Stone chips	Crushers	⊘ <b>ECoP-10.0</b> , "Waste Management"
Safety	Trajectory of Equipments	⊘ Caution Sign, awareness of safety among workers
	Movable Parts of Equipments	⊘ Caution Sign, awareness among workers
	Plant Area / Site	⊘ Caution Sign, Safety Equipments
	Accidents / Health	⊘ First Aid Box, Periodic Medical Check up
	Break down of vehicles	⊘ Arrangement for towing and bringing it to the workshop

13.4.2 During site clearance, all cut and grubbed materials shall be kept at a secured location so that it does not raise any safety concerns.

13.4.3 During excavation, water sprinkling shall be done to minimize dust generation.

13.4.4 Frequent water sprinkling shall be done on the haul roads to minimize dust generation. Incase of loose soils, compaction shall be done prior to water sprinkling.

13.4.5 Cautionary and informatory sign shall be provided at all locations specifying the type of operation in progress.

<sup>5</sup> As per Environmental (Protection) Rules, 1986, Rule 3, Schedule – I, Item 83 B.

- 13.4.6 The contractor must ensure that there is minimum generation of dust and waste while unloading the materials from trucks.
- 13.4.7 The construction waste generated shall be disposed as per **ECoP-10.0**, “Waste Management”.
- 13.4.8 The equipments, which are required to move forward and backward, shall be equipped with alarm for backward movement. It shall be ensure that the workers shall remain away from the working areas at such times.
- 13.4.9 The PIU shall carry out periodic inspections to ensure that all the pollution control systems are appropriately installed and comply with existing emission and noise norms.

### **13.5 Post-construction stage:**

- 13.5.1 The PIU shall ensure that all the haul roads are restored to their original state.
- 13.5.2 In case any inner village road is damaged while transporting the procured material; the contractor shall restore the road to its original condition.
- 13.5.3 The PIU must ensure that the decommissioning of plant shall be done in environmentally sound fashion and the area to brought to its original state.

<b>Safety Measures During Bitumen Construction Work...</b>	
#	The Contractor shall ensure that bitumen storing, handling as well as mixing shall be done at hot-mix plant or designated areas <sup>6</sup> to prevent contamination of soil and ground water.
#	Skilled labour shall be used while hand placing the pre-mixed bitumen material. The hand placing of pre-mixed bituminous material shall be done only in following circumstances: <ul style="list-style-type: none"> <li>○ For laying profile corrective courses of irregular shape and varying thickness</li> <li>○ In confined spaces where it is impracticable for a paver to operate and</li> <li>○ For filling potholes</li> </ul>
#	The Contractor shall provide safety equipments i.e. gumboots and gloves to the workers while handling bitumen.
#	While applying Tack Coat, spraying of bitumen shall be done in the wind direction. The labour shall wear jacket while spraying the bitumen.
#	All the bituminous work shall be done as per IRC’s Manual for Construction and Supervision of Bituminous Works.



---

<sup>6</sup> Designated area refers to paved surfaces and barren parcels of land, with adequate drainage and disposal system. It must be ensured that these are away from agriculture land, water body and other sensitive areas.



## ECoP-14.0 Public and Worker’s Health and Safety

### 14.1 General

14.1.1 The safety and health concerns of the workers and the public are impacted due to the hazards created during the construction of road.

14.1.2 This code of practice describes the measures that need to be taken to mitigate the impacts. **Table 14-1** highlights the key activities that need to be addressed during the different project stages and the significance of impacts in the project regions.

Concerns on Safety of ...	
<b>General Public due to:</b>	
⚡	Improper scheduling of construction activities especially near the settlements and sensitive areas
⚡	Parking of equipments and vehicles at the end of the day is likely to cause accidents to the public especially during night hours.
⚡	Transportation of uncovered loose material or spillage of material increases the chances of accidents to road users and surrounding settlements.
<b>Workers due to:</b>	
⚡	Improper handling of materials like bitumen, oil and other flammable material at construction sites, likely to cause safety concerns to the workers.
⚡	Lack of safety measures such as alarm, awareness and safety equipment result in accidents, especially working with or around heavy machinery / equipments.

**Table 14-1 Significance of Impacts Across Project Regions**

Stages	Key Activities	Significance of Impacts							
		Rajasthan		Himachal		Uttar Pradesh		Jharkhand	
		Arid	Other areas	Low hills	High hills	Flood plains	Other areas	Hills	Plateau
Project Planning & Design Stage	Safety considerations during design								
Pre-construction Stage	Safety & traffic control measures in construction schedule								
Construction Stage	Safety at site								
	Public safety								
Post-Construction Stage	Provision of signages								
	Impacts likely to be significant								
	Impacts not likely to be significant								

### 14.2 Project Planning and Design Stage

14.2.1 To address health and safety concerns of public, during setting up the following, relevant ECoPs as mentioned shall be complied with:

- ⚡ Construction Camps (as per **ECoP-3.0**, “Construction Camps”)
- ⚡ Borrow Areas (as per **ECoP-5.0**, “Borrow Area”) and
- ⚡ New quarry areas (as per **ECoP-7.0**, “Quarry Areas”)

14.2.2 To address the safety concerns to road user during operational phase, the DPR shall contain the following:

- ⚡ Selection and location of regulatory as well as informatory signs as per IRC: 67-2001, depending upon the geometry of the road.

Concerns on Health of...	
<b>Public due to:</b>	
⚡	Unhygienic conditions due to water logging, either by improper decommissioning of Construction Camps and parking lots, or improper disposal of construction wastes, leading to the breeding of vectors that are likely to impact the health of the general public
⚡	Interaction between workers and host community is likely to increase the risk of spread of communicable diseases.
<b>Workers due to:</b>	
⚡	Low quality drinking water as well as inappropriate storage of drinking water likely to cause water borne diseases among workers.
⚡	Absence of proper sanitary facility likely to act as a breeding ground for vectors raising health concerns among workers.

- ⚡ In case of hill roads, provision of passing places and parapet wall shall be included in road design

### 14.3 Pre-construction stage

14.3.1 In order to incorporate public health and safety concerns, the PIU and the Contractor shall disseminate the following information to the community:

- ⚡ Location of construction camps, borrow areas and new quarry areas.
- ⚡ Extent of work
- ⚡ Time of construction
- ⚡ Diversions, if any
- ⚡ Precaution measures in sensitive areas
- ⚡ Involvement of local labours in the road construction
- ⚡ Health issues - water stagnation, exposure to dust, communicable disease
- ⚡ Mechanism for grievances

14.3.2 The Contractor must educate the workers to undertake the health and safety precautions. The contractor shall educate the workers regarding:

- ⚡ Personal safety measures and location of safety devices.
- ⚡ Interaction with the host community
- ⚡ Protection of environment with respect to:
  - Trampling of vegetation and cutting of trees for cooking
  - Restriction of activities in forest areas and also on hunting
  - Water bodies protection
  - Storage and handling of materials
  - Disposal of construction waste

### 14.4 Construction Stage

14.4.1 During the progress of work, following are the safety requirements that need to be undertaken by the contractor at the construction site:

- ⚡ Personal safety equipments (such as footwear and gloves) for the workers
- ⚡ All measures as per bidding document shall be strictly followed
- ⚡ Additional provisions need to be undertaken for safety at site:
  - Adequate lighting arrangement
  - Adequate drainage system to avoid any stagnation of water
  - Lined surface with slope 1:40 (V:H) and provision of lined pit at the bottom, at the storage and handling area of bitumen and oil, as well as at the location of generator (grease trap).
  - Facilities for administering first aid

14.4.2 The following measures need to be adopted by the contractor to address public safety concerns:

- ⚡ The Contractor shall schedule the construction activities taking into consideration factors such as:
  - Sowing of crops
  - Harvesting
  - Local festivals etc.

<b>FIRST AID FACILITIES</b>	
⚡	First Aid Kit, distinctly marked with Red Cross on white back ground and shall contain minimum of following: <ul style="list-style-type: none"> <li>○ 6 small-sterilized dressings</li> <li>○ 3 medium and large sterilized dressings</li> <li>○ 1 (30 ml.) bottles containing 2 % alcoholic solution of iodine</li> <li>○ 1(30 ml) bottle containing salvolatile</li> <li>○ 1 snakebite lancet</li> <li>○ 1 pair sterilized scissors</li> <li>○ 1 copy of first-aid leaflet issued by the Director General, Factory Service &amp; Labour Institute, Government of India</li> <li>○ 100 tablets of aspirin</li> <li>○ Ointment for burns</li> <li>○ A suitable surgical antiseptic solution</li> </ul>
⚡	Adequate arrangement shall be made for immediate recoupment of the equipments, whenever necessary.
⚡	A trained personnel incharge of first aid treatment to be readily available during working hours at construction site
⚡	Suitable transport to the nearest approachable hospital should be made available.

- Availability of labour during particular periods
- ≠ All the cautionary signs as per IRC: 67-2001 and traffic control devices (such as barricades, etc) shall be placed as soon as construction activity get started and shall remain in place till the activities get completed.
- ≠ Following case specific measures need to be followed during the progress of the activity:
  - In case of blasting, the Contractor must follow The Explosives Rules, 1983.
  - In case of construction activity adjoining the water bodies, measures shall be taken as per **ECoP-11.0**, “Water Body”
  - If construction of road is within the settlement, the contractor must ensure there shall not be any unauthorized parking as well as storage of material, adjacent to road.
  - Approved chemicals should be sprayed to prevent breeding of mosquitoes and other disease-causing organisms, at all the water logging areas

14.4.3 The PIU shall carry out periodic inspections in order to ensure that all the measures are being undertaken as per the ECoP.

## **14.5 Post-construction Stage**

14.5.1 During this stage, a major concern is on road user safety. Following are the measures that need to be undertaken by the PIU to ensure safer roads:

- ≠ Inspection and maintenance of installed regulatory and informatory signs.
- ≠ Ensure that the location of signage does not obstruct the visibility
- ≠ In case of hill roads, maintenance of parapet wall as well as of overtaking zones.

14.5.2 The PIU must ensure that during the maintenance operation of road, road materials are stored at a location such that they shall not create any risk to road users.

14.5.3 The construction site shall be cleaned of all debris, scrap materials and machinery on completion of construction for the safety of public and road users, as per the **ECoP-3.0**, “Construction Camp” and **ECoP-10.0**, “Waste Management.”



# ECOP-15.0 Cultural Properties

## 15.1 General

15.1.1 The cultural properties located close to the road are likely to be impacted by the road construction. Most of the properties are avoided in general during finalization of alignment. **Table 15-1** below highlights the key activities that need to be addressed during different stages of the project and also the significance of the impacts in the project regions

**Table 15-1: Significance of Impacts Across Project Region**

Stages	Key Activities	Significance of Impacts							
		Rajasthan		Himachal		Uttar Pradesh		Jharkhand	
		Arid	Other areas	Low hills	High hills	Flood plains	Other areas	Hills	Plateau
Project Planning & Design	Identification of Cultural Properties								
	Avoidance/mitigation measures								
Construction	Precautionary measures								
Post-Construction	Restoration of impacted cultural properties								
	Impacts not likely to be significant								

## 15.2 Project Planning and Design Stage

15.2.1 Measures for mitigation of impacts on cultural properties during project preparation shall be as per the following steps:

- ## Identification of locally significant cultural properties should be done
- ## Assessment of likely impacts on each cultural property due to project implementation
- ## The extent of impact on the identified culture property should be assessed and possible measures for avoidance should be devised based on the site investigation.

15.2.2 In case impact is not avoidable, identification of alternative routes or possibility of relocation of the culture property shall be assessed in consultation with the local public, based on the economic feasibility.

15.2.3 In case of relocation, relocated site should be suggested by the local people and the size of relocated structure should at least be equal to the original structure.

15.2.4 A detailed design of the relocated structure and its site plan along with the necessary BoQ are to be presented DPR. A sample of the drawing for relocation of cultural property and sample BoQ is presented in **Annexure 15-1**.

15.2.5 The relocation and other avoidance measures should be carried out before the start of the road work

15.2.6 It must be ensured by the PIU that the BoQ and rates are incorporated into the contract document.

### Information to be collected...

- ## Location
- ## Direction (North/ South/East/West) With Respect to Road
- ## Distance of the structure from existing centerline of the road
- ## Type of Property eg: temple/mosque/shrine/dargah etc
- ## Plan of the structure
- ## Importance of the structure – historical/social/archeological
- ## Ownership of the property
- ## Probable loss to the property
- ## Specific periods/durations in which large congregations as festivals/mela take place causing hindrance to vehicular movement
- ## Choice of community, issue of relocation

### **15.3 Construction Stage**

15.3.1 Major impacts on the properties during this stage are mainly due to movement of construction machinery as well as due to construction activity near the cultural property. Following are precautionary measures that need to be undertaken by the contractor while working near these structures:

- ## Provision of temporary barricades to isolate the precincts of the cultural property from the construction site shall be devised by the Engineer to avoid impacts.
- ## Restrict movement of heavy machinery near the structure
- ## =Avoid disposal or tipping of earth near the structure
- ## Access to these properties shall be kept clear from dirt and grit

15.3.2 During earth excavation, if any property is unearthed and seems to be culturally significant or likely to have archeological significance, the same shall be intimated to the Engineer. Work shall be suspended until further orders from PIU. The State Archeological Department shall be intimated of the chance find and the Engineer shall carry out a joint inspection with the department. Actions as appropriate shall be intimated to the Contractor along with the probable date for resuming the work.

15.3.3 The PIU must ensure that the contractor implements the precautionary measures as suggested.

### **15.4 Post Construction Stage**

15.4.1 Immediately after completion of construction, the Contractor will affect clearance of the precincts of cultural properties.

15.4.2 In case access to any of the cultural properties is severed during construction; it needs to be restored at the Contractor's cost.

15.4.3 The PIU shall certify restoration of all road links as well as relocated properties before final payment is made.

## ECoP-16.0 Tree Plantation

### 16.1 General

16.1.1 Section 21.4 of PMGSY guidelines specifies that the state governments would take up the planting of fruit bearing and other suitable trees, on both sides of the roads from their own funds. Besides improving aesthetics and ecology of the area, the trees provide fuel wood, act as noise barriers, provide visual screen for sensitive areas and also generate revenue by sale of its produce. However, certain precautions must be taken in design of avenue or cluster plantation so that the trees do not have an adverse impact on road maintenance and/or on safety of the road users. This code of practice elaborates on the approach towards planting trees on PMGSY roads. Emphasis has been laid on a greater involvement of communities and Gram Panchayats in planting and maintenance of roadside trees. The activities requiring addressal during the project stages and the significance of impacts in the project region are presented in **Table 16-1**.

**Table 16-1: Significance of Impacts Across Project Region**

Stages	Key Activities	Significance of Impacts							
		Rajasthan		Himachal		Uttar Pradesh		Jharkhand	
		Arid	Other Areas	Low Hills	High Hills	Flood Plains	Other Areas	Hills	Plateau
Project Planning & Design Stage	Minimising tree felling								
	Plantation Strategies								
	Consultation with PRIs								
Post-construction Stage	Maintenance of trees								
	Impacts not likely to be significant								
	Impacts likely to be significant								

### 16.2 Project Planning and Design Stage

- 16.2.1 During alignment finalisation, due consideration shall be given to minimise the loss of existing tree cover, encroachment of forest areas / protected areas etc as specified in **ECoP-1.0**, "Project Preparation". Tree felling, if unavoidable, shall be done only after compensatory plantation of at least three saplings for every tree cut is done. This shall be carried out by the PIU immaterial of the legal requirements of the state.
- | Plant trees along roads where there is... |  |
|---|--|
| ≠#  | Availability of land for planting          |
| ≠#  | Availability of water                      |
| ≠#  | Willingness of PRI to nurture the saplings |
- 16.2.2 A roadside plantation plan may be prepared by the PIU as part of the DPR, and finalised in consultation with the State Forest Department and PRI. The plantations shall be in accordance with the IRC:SP:21-1979 Manual on Landscaping and IRC:66-1976. The plan may be in the form of avenue trees or cluster plantation. It should be ensured that plantation is carried out only in areas where sufficient water is available during dry seasons and the plant can be protected during the initial stages of their growth. The species shall be identified in consultation with officials of forest department, giving due importance to local flora, It is recommended to plant mixed species in case of both avenue or cluster plantation. The saplings for plantation may be supplied by the Forest Department.
- 16.2.3 Consultations shall include the role of the PRIs in maintaining and managing the trees to be planted in the project. A MoU may be signed between the Gram Panchayat, PIU and Forest Department towards maintenance of the trees, and empowering the PRIs to be entitled to any revenue generated out of these trees. Format for the MoU is attached as **Annexure 16-1**.

Alternately the need for close cooperation shall be covered by a government order. It shall be the responsibility of the Gram Panchayats through the Development Committees to work out institutional mechanisms for managing the plantation and upkeep of trees.

16.2.4 The plantation strategy shall suggest the planting of fruit bearing trees and other suitable trees. Development of cluster plantations will be encouraged in the Government lands, at locations desired by the community. The choice of species will be based on the preferences of the community.

**Do not plant trees ...**

- # Within the line of sight around junctions
- # On the inside of curves
- # Within 5 m of the proposed centre line

16.2.5 In arid areas, shelter-belt plantation shall be proposed as wind breaks, through planting of local hardy shrub and grass species in preference to plantation of trees. The locations of these shelter-belt plantations shall be decided by the PIU in consultation with the PRI and State Forest Department after considering the wind direction, velocity and the likely movement pattern of sand dunes.

**16.3 Post-construction stage**

16.3.1 Planting of saplings from the nurseries as per the plantation plan and the subsequent maintenance of the trees planted may be carried out by the PRI, with its own funds. Planting shall be undertaken in the appropriate season.. The activities to be taken up by the PRI as part of maintenance shall include (i) cutting/lopping branches up to a height of 2.5m above ground level to ensure visibility (ii) Removal of dead wood from the roadway and storing away from roads, and (iii) Weed cutting from shoulders and keeping the shoulders free from any growth of vegetation. In addition, the PRI is to ensure a healthy survival rate by planting replacement saplings in cases where the survival rate is less than 80%.

16.3.2 Watering of trees during the initial period of two to three years shall be the responsibility of the PRI or the agency designated by it. The shoulders of the road shall be kept clear of weeds or any undesirable undergrowth, which may hinder free flow of traffic.

16.3.3 It needs to be ensured that the branches of the trees do not obstruct clear view of the informatory and caution signs

16.3.4 Deciduous trees shed leaves every season. It is necessary to keep the roadway clear of such debris.

16.3.5 Some gaps should be left even in avenue plantation to ensure that the carriageway dries up early after an occasional shower.

Note: The species of trees to be planted has not been suggested, as this should be decided in consultation with the State Forest Department for the particular region, on the basis of requirement on the local community for fuel wood, fodder, etc.

## ECOP-17.0 Managing Induced Development

---

### 17.1 General

17.1.1 Rural lands have a distinct character consisting of productive farmlands with natural areas and limited residential settlement. Developments allowed to grow along the village roads, unless planned and regulated, have the potential to generate traffic and pedestrian movements that can lead to unsafe traffic conditions. Lack of planning controls in the rural areas has allowed roadside development, ranging from individual commercial establishments to continuous stretches of ribbon developments. This code of practice provides measures for regulating the land uses along the roads and tackling induced developments likely along the PMGSY roads. The measures suggest a greater involvement of the Village Panchayats and the Road Authorities for the PMGSY roads. The measures suggested are in accordance with the roles and responsibilities of the PRIs as suggested in the 73<sup>rd</sup> Amendment Act, 1992 and the respective State Panchayat Acts.

### 17.2 Project Planning and Design Stage

17.2.1 As part of the design stage, the PIU may identify areas that are susceptible to induced development impacts. These locations will be finalised in consultation with the Gram Panchayat. It is suggested that the PIU may take initiative in educating the community on the safety issues due to ribbon development.

<b>Locations vulnerable to induced development...</b>
---

- |   |
|---|
| # Lands within 50m of junctions   |
| # Agricultural lands within 100m of settlements   |
| # Stretches within 100m of temples, weekly fairs and locations of community mass gatherings |

17.2.2 The design of access points to the road shall as far as possible conform to certain minimum geometric standards.

### 17.3 Operation stage

17.3.1 The Gram Panchayat / Road authority which ever is applicable, shall lay down restrictions on building activities along the rural roads. Towards this, the recommended standards for building lines and control lines may be followed as stipulated in Table 2.4 of IRC: SP: 20-2002.

<b>Possible development activities along PMGSY roads...</b>
---

- |   |
|---|
| # Residential sites   |
| # Repair shops & Petty shops  |
| # Commercial establishments within settlements                            |
| # Basic amenities – health, education, water pumps etc                    |
| # Village level public buildings  |
| # Selling of produce, informal markets                                    |
| # Developments around specific areas as water bodies, cultural properties |
| # Formal markets & agro-processing units                                  |

17.3.2 Development of Residential Sites Outside Existing Settlement: Apart from the adoption of the recommended standards for building lines, the Gram Panchayat shall encourage local development through education to the communities to construct property with setback from the road rather than on the road.

17.3.3 Development of Repair Shops, Petty Shops at Junctions: A road junction, especially at locations where the village road meets a district road is a typical site where such repair shops, petty shops tend to come up. The Gram Panchayat shall ensure that no such shops or structures come up within the line of sight. Areas for their development shall be demarcated and parking facilities shall be provided to encourage them developing away from the road.

- 17.3.4 While deciding upon the location of community assets, the following preventive measures to address possible induced impacts shall be taken up:
- €# The area around the bus stops has the potential to induce growth of kiosks and petty shops. While this is unavoidable and desirable (to minimize the impact on the road), such growth needs to be encouraged away from the road.
  - €# Community sources of water such as hand pumps are generally sited on the shoulders. It shall be the responsibility of the Gram Panchayat to identify lands outside the Road Land Width and identify any suitable government land accessible from the road. This approach would achieve (i) Safety and (ii) Damage to the road due to water logging, usually around such water sources.
- 17.3.5 The Gram Panchayat shall follow the principles given hereunder while planning and developing small markets / fairs, which include the selling of agricultural produce:
- €# Restricting or planning the activity to one side of the road to minimise pedestrians crossing the road
  - €# Provide parking areas if necessary, and clearly delineating the parking areas from the road
  - €# Providing a good visibility on the approaches to the market area.
  - €# These sites should not be within 150m of the access or egress points of a major junction.
  - €# The commercial areas should be preferably planned lateral to the road than in parallel direction
- 17.3.5.1 In case of Himachal Pradesh, road width and control width will be fixed by the road authority after its declaration as a scheduled road. In Rajasthan the power to fix the control and building lines vests with the road authority under Highways Act. In case of Uttar Pradesh, PRI / Road Authority may be motivated towards avoidance of encroachments on the roads. However, decisions on managing induced development shall be taken by the “Bhumi Prabhandhak Samiti” of the Govt. of UP. In Jharkhand, with the setting up of Gram Panchayats, the provisions as per the 73<sup>rd</sup> Constitutional Amendment Act, 1992 shall be applicable.
- 17.3.6 The Gram Panchayat may take up appropriate measures towards the removal of encroachments onto the public land.
- 17.3.7 The concerns of the communities, about the traffic speed and/or volume through the villages are usually addressed through traffic calming schemes such as road humps or speed breakers/rumble strips along the road. The PIU, where applicable shall incorporate traffic calming schemes in the design aimed at changing the driver’s visual perception of the road environment, as they enter the village, so that they adjust their driving style to better navigate any obstacles encountered. However, such calming devices shall be provided only in the event of provision of adequate signages and pavement marking.

**Role of Gram Panchayats in regulating development along roads – Post 73<sup>rd</sup> Constitutional Amendment, 1992 to the Constitution of India ...**

The 73<sup>rd</sup> Amendment Act, 1992, endows the Panchayats with such powers and authority, as may be necessary to enable them to function as institutions of self-government. The act entrusts the responsibility to the Village Panchayat, planning and implementation of schemes for economic development and social justice as listed in the Eleventh Schedule (243G) of the Constitution. This has been reflected in the State Panchayat Acts as follows.

**Himachal Pradesh:** The Himachal Pradesh Panchayati Raj (Amendment) Act, 1991 provides for the following:

- €# Entrust to the panchayats the responsibility of preparation and implementation of schemes for promoting economic development and social justice, including those on subjects listed in Eleventh Schedule of the Constitution of India. Further,
- €# Empowers the Gram Panchayat to remove encroachments.
- €# Enables the Gram Panchayats to regulate building construction through preparation of a model schemes for the village.
- €# Towards the implementation of these measures, an Amenities Committee be constituted for education, public health, public works and other works

**Rajasthan:** The Rajasthan Government has transferred the functions as per the Eleventh Schedule to the PRIs in 1959. Further, the Rajasthan Panchayati Raj Act, 1994 provides for constitution of a Social Services and

Social Justice Committee, which shall include the management of health, education, roads etc.

**Uttar Pradesh:** The UP Kshetra Panchayat and Zilla Panchayat Adhiniyam, 1961, as amended in 1994, provides guidelines for the activities to be discharged by the Panchayats:

- €# A Gram Panchayat shall prepare every year a development plan for the panchayat area and submit the same to the Kshetra Panchayat.
- €# A Gram Panchayat shall have control of all public streets situated within its jurisdiction, not being a private street.
- €# Every Gram Panchayat shall also be the Bhumi Prabandhak Committee and shall discharge the duties of upkeep, protection and supervision of all properties held by the Gram Panchayat. A Gram Panchayat is empowered to frame by-laws to:
  - Prevent damage to public streets and property
  - Prohibit or regulate the use of public streets or public places by individuals
  - Regulate any other duties or functions of the Gram Panchayat, which shall include development of haats, bazaars, development of abadi sites and any other matter related to control of development.

**Jharkhand:** The Provisions of the Panchayats (Extension to the Scheduled Areas) Act (PESA), 1996, endowed Panchayats at the appropriate level and the Gram Sabha specifically with:

- €# The power to prevent alienation of land in scheduled areas and take appropriate action to restore any unlawfully alienated land of a schedule tribes; - This may be utilized in prevention of encroachments in the scheduled areas.
- €# The power to manage village markets by whatever name called; - This may be utilized in managing local markets / hats
- €# The power to control over local plans and resources for such plans including tribal sub-plans; - This may be utilized in implementing and managing induced development plan in the schedule areas.

Note: In Jharkand other than Schedule Areas, provisions as per 73<sup>rd</sup> Amendment Act, 1992, empowering Panchayats over control of local plans and control of public streets under its jurisdiction shall be applicable..



# ECoP-18.0 Environmental Audit

## 18.1 General

18.1.1 Environmental Audit provides a systematic review of planning, designing, construction practice and operation activities that may have adverse impact on the surrounding environment. Environmental Audit enables identification of:

- ⌘ Degradation/improvement of surrounding ecology
- ⌘ Damage to surrounding habitation and
- ⌘ Extent of compliance with ECoP and other regulatory provisions

18.1.2 Hence PIU should assess whether construction activities comply with environmental standards and other regulatory requirements, by conducting an Environmental Audit. These need to be carried out on a periodic basis.

Aspects for Audit...	
⌘	Alignment finalization
⌘	Site preparation
⌘	Material management
⌘	Drainage
⌘	Slope protection and erosion control
⌘	Water management and economy of use
⌘	Waste generation, management and disposal
⌘	Tree cutting and compensatory plantation
⌘	Siting construction camps, plants and equipments
⌘	Induced Development

## 18.2 Audit Procedure

18.2.1 Safeguards Specialist<sup>7</sup> of Technical Examiner shall be responsible for conduct of the Environmental Audit. It will be conducted in phases corresponding to the phases of the project such as (i) DPR Preparation, (ii) Pre-Construction (iii) Construction and (iv) Post Construction. The audit can be undertaken along with quality assurance checks that need to be conducted by Technical Examiner.

18.2.2 Environmental audit shall be as per the **Checklist-1 & 2** provided in the ECoP. Audit for project preparation, pre-construction and post-construction stages shall be one time, while for construction stage, quarterly audit shall be undertaken. Audit for DPR preparation as per **Checklist –1** will be conducted by the PIU and for the other project stages, audit shall be conducted by the Technical Examiner. The audit findings shall be reported to the State implementing authorities and MoRD on half yearly basis for construction stage. An annual report of the monitoring shall include findings and suggestions of the Audit.

Benefits of Audit	
⌘	Determines the efficiency of practices followed during execution of the work
⌘	Determines the performance of environmental measures suggested
⌘	Assesses the need to undertake additional measures to minimize any adverse environmental impacts identified during the project period
⌘	Audit develops the potential of waste minimization and adoption of recycling and reuse of waste.
⌘	Assist in complying with local, state and national laws and regulation

<sup>7</sup> Implementation arrangements for the project specify inclusion of safeguards specialist. ESMF presents the implementation aspects along with the specific responsibilities.

**Check list-1: Audit Checklist for DPR Preparation**

Sl. No.	Items for inclusion in DPR	Response				Attachments
		Yes	No	NA	Indicate number	
<b>I. Transect Walk</b>						
1	Is transect walk conducted for finalizing the alignment?					Map of Transect Walk
1.1	Is information about transect walk been informed to the public					Annexure 20-1 of ECoP, Formats 2, 3 and 4
<b>II. Initial Consultations</b>						
2	Are consultations conducted with community before alignment finalisation					Suggestions received from community, Annexure 20-3 of ECoP
2.1	Suggestions received on the proposed alignment					Suggestions received and response of PIU, Annexure 20-3 of ECoP
2.2	Consent of land owners towards voluntary land donation					Attach Affidavits/MoU, Annexure-5 of R&PF
3	Are suggestions received from community been incorporated into design					
3.1	Only few suggestions are incorporated					Reasons for not incorporating suggestions from community
3.2	Are reasons for not incorporating suggestions been communicated to the community					
<b>III. Identification of PAPs</b>						
4	Are type and extent of losses due to project identified					
4.1	Agriculture land, ha					Attach profile of PAPs, Annexure-4 of R&PF
4.2	Residential land, ha					
4.3	Commercial land, ha					
4.4	Government/panchayat land, ha					Consent of Panchayat on use of land for road. Format as issued by the respective panchayats
4.5	Forest Area, ha					Forest Clearance as per Forest (conservation) Act
4.6	Loss of common property resources/cultural properties					Attach details of common property resources/cultural properties affected indicating: Type, location, distance from center line and side of road, and extent of impact
5	Are PAPs due to the project identified					List of PAPs and loss suffered due to the project (Annexure 20-1, Format 7 of ECoP may be followed)
6	Are Eligible PAPs identified with respect to following:					List of eligible PAPs and loss suffered due to the project (Annexure 20-1, Format 9 of ECoP may be followed)
6.1	BPL					
6.2	Marginal land owner (less than 3-1/8 acres and losing 10% of residual land)					
6.3	WHH					
6.4	SC/ST					
6.5	Handicapped					
7	Are grievances reported					List of grievances and PAPs
7.1	Type of concerns or grievances					Mechanism for grievance redressal
7.2	Residual grievances if any					Reasons for non addressal
<b>IV. R&amp;R actions</b>						
8	Are provisions for losses been made					List eligible PAPs and provisions, Annexure 20-1, Format 9 of ECoP
8.1	Are provisions of alternate land site made for the identified Eligible PAPs losing land and structure					Details of PAPs and land provided
8.2	Are provisions made for alternate land for ST in scheduled areas under PESA Act					Details of PAPs and type of provisions as per PESA Act
8.3	Are provisions made for inclusion of PAPs losing land/shelter/livelihood under any ongoing Rural Development scheme					Details of Eligible PAPs and schemes under which they are included, Annexure 20-1, Format 9 of ECoP
8.4	Are provisions made for illegal occupants					List of encroachers/squatters and provisions
9	Are consultations conducted during project preparation cover the following:					Record of the consultation session, Annexure 20-3 of ECoP
9.1	Accommodating migrant labourers and					

Sl. No.	Items for inclusion in DPR	Response				Attachments
		Yes	No	NA	Indicate number	
	construction camps near settlement					
9.2	Awareness of residents towards health issues including HIV/AIDS due to provision of road					
<b>V. Environmental Clearances</b>						
10	Environmental clearances to be obtained, if required					Copy of Clearance obtained, Format of clearances as per relevant Acts
10.1	SPCB					Copy of application form submitted if clearance is pending. Format of application as per relevant Acts
10.2	Forest Department					
10.3	MoEF (in case of black topping in Himalayas)					
<b>VI. Surveys Conducted</b>						
11	Are detailed surveys conducted for the project					Information presented in DPR
11.1	Geological Studies					
11.2	Hydrological Studies					
11.3	Topographical Studies					
11.4	Was peg marking carried out to delineate the proposed alignment					
<b>VII. Loss of common property resources</b>						
12	Are provisions made to community losing common property resources, assets or utilities, if any					Type of loss and arrangements made
13	Are provisions for relocation of cultural properties been made					Location map of relocation
<b>VIII. Material source identification, extraction and rehabilitation</b>						
14	Are provisions made in specifications for identification of borrow areas to reduce cost and use waste materials					
15	Are provisions made for rehabilitation of borrow areas in the DPR/Specifications					
16	Were sources of alternate materials explored or provisions made for utilizing them, incase lead for stone ballast is excessive, to reduce cost and use waste materials.					Properties of alternative materials and extent of utilization
17	Is material from existing quarries in sufficient quantities for the project					
17.1	If answer to No. 17 is no, then are arrangements made for identification, extraction, rehabilitation of new quarries as per ECoP					
18	Is the project area water scarce?					
18.1	If answer to No. 18 is yes, are possibilities of use of existing water sources identified in consultation with the villagers, PRI or Govt. Departments? (Community water sources to be used only with their consent)					List of existing perennial sources prepared
18.2	Are provisions in the specifications made for identification, procurement and rehabilitation arrangements to be carried out by the contractor as per ECoP					
<b>IX. Water Bodies</b>						
19	Does the alignment cut across or passing adjacent to water body?					
19.1	Are consultations conducted with community for seeking consent and measures to be taken to mitigated impacts					
19.2	Are detailed designs prepared indicating pond to be affected					Detailed blown up drawing indicating the pond
19.3	Are provisions made for control of pollution of pond water during construction					
19.4	Are provisions made for rehabilitation of the water body, if affected					
<b>X. Slope Stability, Soil Erosion &amp; Top soil conservation</b>						
20	Is stability analysis carried out for the breast walls/retaining walls					Information to be included in DPR
21	Are slope stabilization measures included in the DPR					Locations of measures where required along with the measures suggested
22	Are erosion control measures included in the DPR					Locations of measures required and measures suggested

Sl. No.	Items for inclusion in DPR	Response				Attachments
		Yes	No	NA	Indicate number	
23	Are species of vegetation to be grown over the steep slopes determined					List of species
24	Are provisions made for conservation of topsoil in stockpiles			*		* Shall be applicable only in cases where topsoil is devoid of any fertility or humus as in desert areas and higher Himalayan regions where topography is mostly comprised of glacial ice. In other areas the answer can be either 'Yes' or 'No'
24.1	Are stockpile preservation techniques included in the specifications for the activities of the contractor					
24.2	Is reuse of topsoil by been included in the special conditions of contract					
24.3	Has special provisions such as chutes been made to protect high banks					
<b>XI. Drainage</b>						
25	Does hydrological studies indicate afflux greater than 450mm due to construction of cross drainage structures					Locations, height of afflux and discharge expected
25.1	Are culverts at such locations designed to handle the afflux and to ensure that upstream areas do not get flooded and excessive scour caused on downstream nor fields affected					Reasons for not providing culverts
25.2	Are outfalls identified for discharge from the openings capable of disposing it					
25.3	In case existing outfalls are not adequate, are alternate locations for discharge identified					Information on alternate discharge outfalls to be presented
26	Are provisions for stone lined side drains in high rainfall areas and hill areas made in the DPR					
27	Are provisions for channel drains in case of high embankments (> 1.5m) been made in the DPR					Locations where specified
28	Are contractor's responsibilities as per ECoP-13 in Pre-construction and construction stages included as part of specifications					
29	Are provisions made in the DPR for erection of safety devises, flood warning signs and warning posts at construction locations over drainage channels					
30	Has provision been made for construction of siphons for irrigation channels and PAPs informed about it					
<b>XII. Forests &amp; Tree Plantation</b>						
31	Are trees being cut by the project, if yes indicate number of trees felled					
31.1	Is clearance from the forest department obtained					
31.2	Is land identified for compensatory plantation					
31.3	Is roadside plantation being taken up? If yes indicate number of trees being planted					
31.4	Are arrangements for supply of saplings from forest department and maintenance by PRI being made?					
32	Is any forest land being diverted for the project					
32.1	If yes to No. 32, is clearance from forest department obtained?					Clearance from Forest Department
32.2	Is land identified for handing over to forest department					Details of land use/area of land identified
32.3	Are provisions made in the specifications to avoid setting up of construction camps/borrow areas and new quarry areas in the forest areas?					
<b>XIII. Natural Habitat</b>						
33	Does any natural habitat as per ECoP 19 exists along the project corridor					
33.1	Is inventorization of ecological features being done during transect walk					
33.2	Are provision for road design made as per ECoP					
33.3	Is Natural habitat Management Plan prepared					Natural Habitat Management Plan, ECoP-19.0
33.3.1	If yes, are all aspect as per ECoP 19, Clause 19.2.7					
<b>XIV. Pollution Prevention measures</b>						
34	Are provisions made for administering pollution control measures at construction sites as per ECoP					
35	Are provisions made for safe disposal of wastes					Location of disposal sites and

Sl. No.	Items for inclusion in DPR	Response				Attachments
		Yes	No	NA	Indicate number	
	from construction sites					arrangements made for safe disposal
<b>XV. Safety</b>						
36	Are provisions made for worker's health & hygiene at construction camps					Layout of construction camp with arrangements for health & hygiene of workers, Conceptual layout given as Annexure-3.1 of ECoP
37	Are provisions made for traffic diversions during construction					Provide in bid document
37.1	Are traffic diversions / closure of traffic been intimated to the public					
38	Are provisions made for signage, demarcating cones and tapes during construction on tracks being utilized by traffic at present					
39	Are provisions made for supply of Personal Protective Equipment to the workers					Reference to the bill of quantities
40	Are provisions made for construction of parapet walls on hill roads for safety of road user					
<b>XVI. Finalisation of Alignment</b>						
41	Are designs conforming to IRC standards, if no then are the following criteria adopted. Indicate RoW					
41.1	Design speed considered is not be less than 40 km/hr in plain areas and 35 km/hr in rolling terrain					
41.2	Roadway width of 6m for link routes & 9m in cutting sections in desert areas					Locations where provided
41.3	Carriageway width of 3.75m to be adopted universally. If no, indicate width adopted					
41.4	Embankment Height of 0.3 to 0.4 m in arid & sandy areas. Follows natural topography in desert areas					
41.5	Minimum absolute curve radius of 50m @ 40 km/hr and 38 m @ 35 km/hr					
41.6	Junction design in conformance to IRC: SP-20: 2002					
42	Are enhancements mentioned in ECoP provided in the design - mention details against each given below					
42.1	Cattle crossings at their normal crossing routes for safety of cattle and road user					Design (conceptual sketch as in ECoP-1.0) & locations
42.2	Cross roads for access to & from agriculture lands to avoid damage to embankment and roadside drain					Design (conceptual sketch as in ECoP-1.0) & locations
42.3	Paved shoulders at destination and villages enroute and provide bus bays					Design (conceptual sketch as in ECoP-1.0) & locations
42.4	Widening of embankment where possible to provide a platform for storing maintenance materials					Design (conceptual sketch as in ECoP-1.0) & Locations where provided
<b>XVII. Induced Development</b>						
43	Are provisions made for demarcating lands for use of service shops					Location & area
44	Are provisions made for avoiding encroachments onto the available road width					
45	Are provisions made for control of development along the road near locations vulnerable to induced development					
<b>XVIII. Monitoring</b>						
46	Are provisions made for supervision of implementation of the environmental measures as per ECoP					
47	Are steps provided for inspection of the bridges and culverts					

## Check list -2A: Environmental Audit Checklist during Pre-Construction Stage

Sl.No.	Activity	Impacts	Measure/s suggested as per ECoP	ECoP Applicable	Additional Information	Measures Implemented	Compliance with ECoP		
							Yes	No	NA
2A	Pre – Construction Activities								
A1.0	Alignment marking	Nil	(i) Co-ordination with Revenue Department	ECoP 1.0 ECoP 2.0					
A2.0	Relocation of utilities	Impact on current usage	(i) Identification of relocation site in advance	ECoP 2.0					
			(ii) Preferably Scheduling the activity in consonance with the community usage pattern	ECoP 2.0					
A3.0	Tree Felling	Compliance with Forest Act in case trees are on forest land	(i) Prior clearance from Forest Department	ECoP 1.0					
		Loss of canopy	(ii) Compensatory plantations as per roadside plantation plan	ECoP 16.0					
A4.0	Clearance of land	Affect on livelihood	(i) Compensation as per project provisions	ECoP2.0					
		Affect on standing crops	(ii) Scheduling of activity and coordination	ECoP 1.0					
		Affect on cultural properties	(iii) Modification of alignment or Relocation of the cultural properties	ECoP 15.0					
		Affect on natural habitats	(iv) No clearance of vegetation beyond existing road land width.	ECoP 19.0					
A5.0	Diversion of forest land	Compliance with Forest Act	(i) Activity scheduling to avoid delays, conformance to legal requirements	ECoP 1.0					
		Affect on flora	(ii) Precautionary measures during construction in forest areas	All ECoP					
		Pollution from construction activities	(iii) Precautions while operating equipment/machinery	ECoP 13.0					
A6.0	Transfer of land ownership	Grievances from community	(i) Addressal through Grievance Redressal Mechanisms & Consultations	ECoP 1.0 ECoP 20.0					
		Affect on livelihood	(ii) Provision of entitlements as per resettlement framework	ECoP 1.0					
A7.0	Location of Storage Yards, labour camps, and construction sites	Pollution from construction camps, storage yards & labour camps	(i) Location criteria to be adopted	ECoP 3.0 ECoP 20.0	● Indicate location if not as per ECoP ● Number of workers - male & female				
			(ii) Obtain clearances from PCB	ECoP 1.0					
		Pressure on local infrastructure	(iii) Infrastructure arrangements to be as per guidelines	ECoP 3.0	● Siting of Construction Camps				
				ECoP 3.0	● Drinking Water Provision				
				ECoP 3.0	● Adequate Sanitary Arrangement				
				ECoP 3.0	● Arrangement for Waste Disposal				
				ECoP 3.0	● Lighting Arrangement				
				ECoP 3.0	● First Aid Facility				
				ECoP 3.0	● Fire Fighting Arrangement				
				ECoP 3.0	● Interaction with the host community				
A8.0	Procurement of equipments and machinery	Machinery likely to cause pollution	(i) Machinery to be procured shall be in conformance with noise and emission standards of CPCB	ECoP 13.0 ECoP 19.0					
		Safety concerns in machinery operation	(ii) Safety equipment for workers	ECoP 14.0					
A9.0	Identification and Selection of Material Sources	Conflict of uses in case of water	(i) Consultations and arrangements at contractor-individual levels, documentation of agreement for water for construction	ECoP 8.0 ECoP 20.0	● Provide construction schedule				

Sl.No.	Activity	Impacts	Measure/s suggested as per ECoP	ECoP Applicable	Additional Information	Measures Implemented	Compliance with ECoP		
							Yes	No	NA
		Borrowing causes depressed lands	(ii) Consultations and arrangements at contractor-individual levels, documentation of agreement for Borrow areas	ECoP 5.0	<ul style="list-style-type: none"> <li>• Indicate location of Borrow areas In case</li> <li>• of areas other than on road side provide - lead from project road (km), Haul Road condition (Blacktopped, Gravel, Earthen road) Landuse of identified borrow area Redevelopment plan</li> </ul>				
		Pollution due to material extraction from borrow and quarry areas to surrounding environment	(iii) Precautionary measures during siting of borrow areas and quarry areas	ECoP 5.0 ECoP 7.0					
		Disturbance to Natural Habitats	(iv) Avoidance of location of material sources in Natural Habitats	ECoP 19.0	Natural Habitat Management Plan				
A10.0	Identification of designated locations of waste disposal	Pollution due to location close to settlements, water bodies & other sensitive areas	(i) Site selection in conformance to criteria provided	ECoP 10.0					

## Check list -2B: Environmental Audit Checklist during Construction Stage

SL.No.	Activity	Impacts	Measure/s suggested as per ECoP	ECoP Applicable	Additional Information	Measures Implemented	Compliance with ECoP		
							Yes	No	NA
<b>2B</b>	<b>Construction Activities</b>								
<b>B1.0</b>	<b>Site Clearance</b>								
B1.1	Clearing and Grubbing	Effect on roadside vegetation	(i) Restricting movement of machinery/equipment	ECoP 2.0 ECoP 13.0					
		Debris generation creating unsightly conditions	(ii) Disposal / storage of grubbing waste and possible reuse	ECoP 10.0					
B1.2	Dismantling of existing culverts and structures, if any	Generation of Debris creating unsightly conditions	(i) Disposal of waste and likely reuse	ECoP 10.0					
		Flooding due to interception to drainage paths	(ii) Provision of diversion channels and/or scheduling construction of culverts in dry months	ECoP 12.0					
<b>B2.0</b>	<b>Planning Traffic diversions and Detours</b>	Trampling of vegetation along traffic diversions	(i) Activity scheduling, identification of alternative track	ECoP 14.0					
<b>B3.0</b>	<b>Material Procurement</b>	Loss of topsoil	(i) Stripping & Storing topsoil	ECoP 6.0	<ul style="list-style-type: none"> <li>• Location &amp; quantity of topsoil stored</li> <li>• Space reserved for storing topsoil (% of area opened for construction activities)</li> <li>• Stabilisation measures for stockpile</li> </ul>				
		Formation of stagnant water pools due to borrowing/quarrying	(ii) Rehabilitation plan for borrow areas & quarry areas (new quarry)	ECoP 5.0 ECoP 7.0	In case new quarries are opened for the project provide following information <ul style="list-style-type: none"> <li>• Material Procured from quarry</li> <li>• Provisions of Drainage in the site</li> <li>• Rehabilitation Plan to be enclosed</li> </ul>				
		Illegal quarrying / sand mining	(iii) Conformance of quarries selected to the SPCB requirements, including quarry restoration plans	ECoP 7.0	• Clearance from Mining Department				
		Uncontrolled blasting at quarries	(iv) Controlled blasting to the extent required. Conformance to blasting rules as per the Indian Explosives Act	ECoP 7.0					
<b>B4.0</b>	<b>Transport of materials to site</b>	Fugitive emissions from transport trucks	(i) Covering of material with tarpaulin or use of covered box trucks during transport	ECoP 10.0					
		Dust emissions from haul roads	(ii) Haul road management	ECoP 13.0	• Indicate if new haul roads are constructed				
<b>B5.0</b>	<b>Materials handling at site</b>								
	Handling of materials	Risk of injury to workers	(i) Use of Personal Protective Equipment (PPE)	ECoP 14.0	• Mention PPE provided to workers				
B5.1	Storage of materials	Contamination to water sources, leaching into ground water	(ii) Provision of impervious base to storage areas	ECoP 3.0					
B5.2	Handling of earth	Dust rising and increase in particulate concentration in ambient air	(iii) Use of dust suppressants	ECoP 13.0					
B5.3	Handling of fly ash	Increase of particulate concentration and contamination of nearby areas	(iv) Use of dust suppressants	ECoP 4.0					
B5.4	Handling of granular material	Risk of injury to workers	(v) Use of Personal Protective Equipment	ECoP 14.0					
B5.5	Handling of bituminous materials	Leaching of materials, contamination of water sources	(vi) Provision of impervious base at bitumen storage areas	ECoP 10.0					
		Air pollution	(vii) Control of emissions from mixing	ECoP 13.0					
B5.6	Handling of oil/diesel	Contamination from accidental spills	(viii) Prevention of accidental spills, affecting cleaning immediately after spill	ECoP 13.0					
		Pollution due to incomplete burning	(ix) Ensure complete combustion of fuel through regular maintenance of equipment	ECoP 13.0					

Sl.No.	Activity	Impacts	Measure/s suggested as per ECoP	ECoP Applicable	Additional Information	Measures Implemented	Compliance with ECoP		
							Yes	No	NA
B5.7	Waste management	Littering of debris at construction site	(x) Waste to be disposed at disposal locations only	ECoP 10.0	Location of Disposal Site Type of waste Disposal type or reuse				
		Contamination of surroundings due to runoff from construction site	(xi) Prevention of runoff from entering water bodies	ECoP 11.0					
B5.8	Operation of construction equipments and machinery	Air & Noise pollution	(xii) Conformance to Emission standards and norms	ECoP 13.0					
		Operational safety of workers	(xiii) Conformance to Safety concerns of the road users and workers in operation, first aid provision and mandatory provision of Personal Protective Equipment (PPE)	ECoP 14.0	Mention PPE provided to workers Signage as per provisions of IRC for safety of road users				
B5.9	Movement of Machinery	Trampling of vegetation	(xiv) Restriction of movement within ROW	ECoP 13.0					
		Damage to flora	(xv) Minimizing impact on vegetation	ECoP 13.0 ECoP 19.0					
		Damage to road side properties	(xvi) Minimizing impacts on private and common properties, including religious structures	ECoP 13.0 ECoP 15.0					
<b>B6.0</b>	<b>Earthworks</b>								
B6.1	Cutting	Uncontrolled blasting in case of rock cutting	(i) Controlled blasting to be made mandatory	ECoP 7.0					
		Loss of topsoil	(ii) Preservation of topsoil for reuse	ECoP 6.0	Quantity of topsoil generated (cum) Period of Preservation (No. of days) Stabilisation measures undertaken				
		Affect on water bodies	(iii) Precautions to be taken while working close to water bodies	ECoP 11.0					
		Waste generation	(iv) Safe disposal of waste & possible reuse	ECoP 10.0					
B6.2	Embankment construction	Interruption to drainage	(i) Drainage channels to be provided with culverts in advance to embankment construction	ECoP 12.0					
		Dust Rising	(ii) Dust suppression with water	ECoP 13.0					
		Excess water/material usage	(iii) Minimising height of embankment	ECoP 1.0					
			(iv) Scheduling embankment construction in wet months, if possible	ECoP 1.0					
			(v) Compaction with vibratory rollers is suggested	ECoP 1.0					
		Erosion causing impact on embankment/slope stability	(v) Slope stabilization measures as seeding, mulching & bio-engineering techniques	ECoP 9.0		Indicate type of measures implemented			
		Formation of rills / gullies	(vi) Construction of temporary erosion control structures as per requirements	ECoP 9.0					
		Contamination of water bodies/ water courses	(vii) Control measures as silt fencing, vegetative barriers etc	ECoP 9.0					
			(viii) Avoiding disposal of liquid wastes into natural water courses	ECoP 11.0					
B6.3	Maintenance at construction camp	Collection of rainwater in construction camps	(ix) Temporary drains during construction	ECoP 3.0					
		Waste water from labour camps	(x) Disposal of waste water into soakpits/sumps	ECoP 3.0					
		Contamination of soil	(xi) Removal of oil / other chemical spills & wastes	ECoP 3.0					
B6.4	Cutting embankments of surface water bodies	Impact on the drainage flows in and out of the water body	(xii) Restoration of drainage channels	ECoP 11.0					
		Embankment stability	(xiii) Design of slopes of the water bodies, slope protection etc	ECoP 9.0					
<b>B7.0</b>	<b>Sub-Base &amp; Base courses</b>								
B7.1	Granular sub-base	Extensive extraction of quarry materials	(i) Use of locally available materials (licensed quarry)	ECoP 4.0					

Sl.No.	Activity	Impacts	Measure/s suggested as per ECoP	ECoP Applicable	Additional Information	Measures Implemented	Compliance with ECoP		
							Yes	No	NA
B7.2	Wet mix macadam	Extensive water requirement	(ii) Scheduling the activity preferably in wet months	ECoP 1.0					
			(iii) Avoiding conflict of uses due to water extraction from construction	ECoP 8.0					
B7.3	Shoulders treatment	Movement of Machinery for compaction	(iv) Restricting movement on adjacent lands	ECoP 13.0					
<b>B8.0</b>	<b>Culverts and Minor Bridge Works</b>	Interruption to water flow	(i) Provision of diversion channels	ECoP 12.0					
		Pollution of water channels during construction	(ii) Control of sediment runoff	ECoP 12.0					
		Safety of Workers	(iii) Mandatory use of Personal Protective Equipment	ECoP 14.0					
<b>B9.0</b>	<b>Surfacing</b>								
B9.1	Bituminous surface	Worker's safety during handling of hot mix	(i) Mandatory use of Personal Protective Equipment	ECoP 14.0					
		Damage to vegetation (burning/cutting)	(ii) Avoiding use of wood as fuel for heating bitumen	ECoP 13.0					
			(iii) Hot mix plant location to be preferably on waste lands	ECoP 13.0					
		Contamination due to bituminous wastes	(iv) Reuse or Land filling of bituminous wastes	ECoP 10.0					
		Impacts on Air quality	(v) Ensuring compliance of hotmix plants with the CPCB emission standards	ECoP 13.0					
B9.2	Concrete surfacing for roads crossing built up areas	Contamination of surroundings due to concrete mixing	(vi) Mixing concrete at designated locations away from habitation and agriculture lands	ECoP 3.0					
<b>B10.0</b>	<b>Road furniture/Signage</b>	-Nil-	(i) To be provided as per design						
<b>B11.0</b>	<b>Shoulder protection</b>	Requires material extraction from quarries	(i) Use locally available material	ECoP 4.0					
			(ii) Ensure that all shoulders are clear of debris or construction materials	ECoP 13.0					
<b>B12.0</b>	<b>Enhancements</b>	-Nil-	(i) To be included in DPR	ECoP 1.0 ECoP 20.0					
<b>B13.0</b>	<b>Monitoring environmental conditions</b>	-Nil-	(i) To be as per the codes of environmental practice	ECoP 18.0					

## Check list -2C: Environmental Audit Checklist during Post-Construction Stage

SL.No.	Activity	Impacts	Measure/s suggested as per ECoP	ECoP Applicable	Additional Information	Measures Implemented	Compliance with ECoP		
							Yes	No	NA
<b>C</b>	<b>Post Construction Activities</b>								
<b>C1.0</b>	<b>Clearing of construction camps</b>								
C1.1	Campsite restoration	Change of landuse due to setting up of construction camp	(i) Campsite to be restored to its original condition as per the rehabilitation plan	ECoP 3.0					
			(ii) Restoration of top soil	ECoP 6.0					
C1.2	Dismantling of campsite	Waste generation at the construction site	(iii) Disposal of waste at designated locations	ECoP 10.0					
<b>C2.0</b>	<b>Clearing of Water Channels, side drains and culverts</b>	Generation of debris & silt	(i) Removal of Debris and disposal	ECoP 11.0 ECoP 12.0					
<b>C3.0</b>	<b>Rehabilitation of borrow areas/quarry areas</b>	-Nil-	(i) Top soil restoration, revegetation	ECoP 5.0					
		-Nil-	(ii) Restoration of haul roads	ECoP 7.0					
<b>C4.0</b>	<b>Revegetation of embankment slopes and slope stabilisation measures undertaken</b>	Erosion of slopes due to runoff or high wind speeds	(i) Revegetation of slopes with native species	ECoP 9.0					
<b>C5.0</b>	<b>Rehabilitation of water bodies</b>	-Nil-	(i) Measures to reconstruct embankment in case it is affected	ECoP 11.0					
<b>C6.0</b>	<b>Restoration of cultural properties</b>	Effect on Aesthetics	(i) The precincts of the cultural properties have to be cleared of any debris	ECoP 15.0					
			(ii) Access to the cultural property is to be restored immediately after completion of construction	ECoP 15.0					
<b>C7.0</b>	<b>Tree Plantation</b>		(i) Tree plantation is to be carried out by the community preferably with inputs from Forest department	ECoP 16.0	<ul style="list-style-type: none"> <li>• Indicate agency responsible for plantation</li> <li>• Number of saplings planted</li> <li>• Survival rate of plantation</li> </ul>				
<b>C8.0</b>	<b>Preventing Induced Development</b>	Congestion on roads and impairment of safety of road users	(i) Issue of notification on building lines and control lines	ECoP 17.0					
			(ii) Assigning responsibility to PRI (or any other agency) for control of encroachment	ECoP 17.0	• Indicate the responsible agency				
C8.1	Clearing of encroachments	Loss of livelihood	(iii) Precautionary measures to avoid encroachments	ECoP 17.0					



## ECoP-19.0 Natural Habitats

### 19.1 General

19.1.1 This code of practice envisages measures to be undertaken during blacktopping / widening of PMGSY Road passing through designated natural habitats. These measures shall be undertaken in addition to the measures laid down in the other ECoPs.

#### Designated Natural Habitats

- # National Park
- # Reserve Forest
- # Sanctuaries
- # Notified Wetlands
- # Fisheries and Aquatic Habitats

19.1.2 As per the World Bank OP 4.04, the conservation of natural habitats, like other measures that protect and enhance the environment, is essential for long-term sustainable development. A precautionary approach to natural resource management to ensure opportunities for environmentally sustainable development has been adopted for the project.

#### Main features of the Bank's Natural Habitats Policy (OP 4.04)

Natural habitats are land and water areas where (i) the ecosystems' biological communities are formed largely by native plant and animal species, and (ii) human activity has not essentially modified the areas primary ecological functions. The policy on natural habitats contains two major provisions with respect to biodiversity conservation and EA. Firstly, it prohibits Bank involvement in projects, which involve significant conversion or degradation of critical natural habitats. These include: existing protected areas and adjoining or linked areas or resources (such as water sources) on which the protected areas depend; and sites identified as meriting protection. Secondly, where natural habitats out-side protected areas are within a project's area of influence, the project must not convert them significantly unless:

- # There are no feasible alternatives
- # The EA demonstrates that benefits substantially outweigh the costs
- # Mitigation measures acceptable to the Bank are implemented, which would normally include support for one or more compensatory protected areas that are ecologically similar to, and no smaller than, the natural habitats adversely affected by the project

#### Applicability:

With the above understanding of the Natural Habitats Policy (OP 4.04), following areas are identified to be Critical Natural Habitats designated as per the prevailing GoI/state level legal provisions. It has to be ensured while finalizing the alignment that these designated natural habitats are not being cut across or not adjoining the alignment to the extent that they will be impacted.

- i. Protected Areas (Sanctuaries, National Parks and Closed Areas) defined under The Wild Life (Protection) Amendment Act, 2002 and The Indian Wildlife (Protection) Act, 1972, amended 1993
- ii. Notified Wetlands: As per the Ramsar Convention, 1971, Wetlands are areas of marsh, fen, peatland or water, whether natural or artificial, permanent or temporary, with water that is static or flowing, fresh, brackish or salt, including areas of marine water the depth of which at low tide does not exceed six meters. This definition encompasses coastal and shallow marine areas (including coral reefs), as well as river courses and temporary lakes or depressions in semi-arid zones.
- iii. Fisheries and Aquatic Habitats as per provisions of (a) HP Fisheries Act 1976 (for the state of Himachal Pradesh) (b) The Rajasthan Fisheries Act, 1953 (for the state of Rajasthan). For the purpose of this ECoP in the other two states Uttar Pradesh and Jharkhand as no fisheries acts are in force, habitats similar in nature to those in the above two acts, shall be considered as a critical natural habitat.

### 19.2 Project Planning and Design

19.2.1 To minimize the adverse impact on the ecology of the natural habitats, selection of alignment should be as per **ECoP-1.0**, "Project Planning & Design".

19.2.2 An officer of atleast the rank of a forest ranger shall make an inventory of the main ecological features along the PMGSY Road. The inventory shall be carried out as the ranger travels along the proposed alignment during the transect walk.

- 19.2.3 The nature and type of impact on natural habitats due to road construction shall be identified. Magnitude of the impact to the extent feasible on the ecological features shall also be assessed.

Ecological Features...	Adverse Impacts...
## Area of natural habitat	## Diversion of forest land
## Type and number of endangered species of flora and fauna	## Cutting of trees
## Stream and water bodies	## Trampling of vegetation
## Breeding ground and seasons	## Contamination of water due to the usage of water from the source within the natural habitat
## Migration season of bird species	## Loss of breeding grounds
## Animal crossing	## Interruption to animal crossings during the construction

- 19.2.4 Impacts identified on the natural habitats shall be minimized to the extent required. Minimization shall be through precautionary measures or through appropriate mitigation measures. Following are the measures undertaken along the road passing through natural habitats:

- ## Constricting the roadway width to 6.0 m to minimize the extent of diversion of forest land and cutting of trees
- ## Traffic calming devices shall be introduced where necessary.
- ## Signage (viz. speed limit, animal crossing, switch of headlight etc) shall be provided as per IRC: 67-2001 Code of Practice for road sign (first revision)

- 19.2.5 In addition to the above measures, specific impacts identified on site shall be mitigated as per the recommendation of the forest department / officer in charge of the identified natural habitat.

- 19.2.6 In case proposed alignment falls within the catchment of a water body or a stream, a flush causeway shall be constructed without impacting the drainage system. The length of the causeway shall be as per the existing water spread. The causeway shall be strictly in compliance with IRC:SP-20:2002. In no circumstances a water body within the natural habitat shall be cut across or filled for the purpose of laying the road.

- 19.2.7 A Natural Habitat Management Plan shall be prepared for the stretch passing through designated natural habitat covering the following aspects:

- ## **Project Description**, describing the project background along with project objective and benefits.
- ## **Policy, legal & Administrative framework:** highlighting the institutional setting and legal framework along with the clearance required for the project.
- ## **Baseline environmental / ecological profile** highlighting the existing scenario along the PMGSY Road as well as in its influential area.
- ## **Analysis of Alternatives** describing design alternatives and analyze them to evaluate best-fit option.
- ## **Identification and Assessment of Impact:** adverse impact shall be identified and evaluated in compliance with ECoP's for the best-fit option.
- ## **Management Plan** describing the avoidance as well as mitigation measures shall be suggested along with the monitoring and implementation mechanism.
- ## **Budgetary Provision** describing the costs associated with the management measures.

### 19.3 Pre-construction Stage:

- 19.3.1 No Construction Camps, Stockyards, Concrete Batching or Hot Mix Plants shall be located within any designated natural habitat or within 500m from its boundary.
- 19.3.2 Contractor in consultation with forest ranger or any other concerned authority shall prepare a schedule of construction within the natural habitat. Due consideration shall be given to the time

of migration, time of crossing, breeding habits and any other special phenomena taking place in the area for the concerned flora or fauna.

#### **19.4 Construction Stage:**

- 19.4.1 Procurement of any kind of construction material (as quarry or borrow material) from within the natural habitat shall be strictly prohibited
- 19.4.2 No water resources within the natural habitat shall be tapped for road construction.
- 19.4.3 Use of mechanized equipment shall be kept minimum within the natural habitat. Contractor must ensure that there will be no parking of vehicles machine and equipment within the natural habitat.
- 19.4.4 Disposal of construction waste within the natural habitat shall be strictly prohibited and as far as possible reuse shall be undertaken as per Table 10-2 type of waste of **ECOP-10.0**, “Waste Management”.
- 19.4.5 PIU shall nominate one expert to carry out audit at all stages of project in accordance with Checklist A, B and C of **ECOP-18.0**, “Environmental Audit” to ensure all provision are followed as per ECoPs.

#### **19.5 Post Construction Stage:**

- 19.5.1 The road passing through the natural habitat shall be declared as a silence zone and provisions as per clause 19.2.4 of this ECoP shall be made.
- 19.5.2 Compensatory tree plantation within the available Right of Way shall be done in accordance with **ECOP-16.0**, “Tree Plantation”.
- 19.5.3 The PIU must ensure maintenance of drainage structure shall be undertaken as per **ECOP-12.0**, “Drainage”



# ECoP-20.0 Consultations for Environmental Aspects

---

## 20.1 General

- 20.1.1 All stages of project planning, preparation and implementation will involve interaction with the community. Consultations with community or other stakeholders are an integral part of the project activities. These would in general be conducted by the PIU in prioritization and project preparation and post-construction stages. While during pre-construction PIU / Contractor and in construction stages the contractor will be conducting the consultations. This ECoP is intended to provide guidelines for the PIU/Contractor for conducting the consultations.

### Consultations to be conducted ...

- ##Information dissemination about proposed PMGSY roads under core network
- ##During Project Preparation
  - ##Dissemination of project information
  - ##For finalizing alignment
  - ##For disseminating information on incorporation/non-incorporation of environmental concerns into project design
- ##During Implementation for...
  - ##Seeking consent on temporary use of land for setting up construction facilities, borrowing, traffic diversions and disposal of wastes
  - ##Seeking consent on extraction of water for construction, relocation of common property resources and cultural properties
  - ##Encouraging tree plantation and
  - ##Avoiding / minimizing induced development

## 20.2 Project Preparation Stage

- 20.2.1 The proposed PMGSY roads under core network shall be displayed at Zilla Parishad headquarters. Thereafter each road shall be taken up for preparation of DPR as per priority formula adopted by the State Government.
- 20.2.2 During the DPR stage, information on the connectivity, and other provisions of ESMF shall be disseminated at the village Panchayat of the concerned habitation in the form of Brochure as presented in **Annexure 20-1**. It shall indicate the need for adequate land width and voluntary land donation.
- 20.2.3 To enable incorporation of environmental and social concerns into the project preparation, an inventory of environmental and social features of the road is prepared. This is done through a Transect Walk. The transect walk shall be a participatory process organized by the PIU in coordination with the Gram Panchayat and the revenue officials at the village level. In case, the proposed alignment is likely to pass through a natural habitat (as per **ECOP-19.0**, “Natural Habitats”) then an official from Forest Department would also be accompanying the team. Details of the conduct of transect walk are as per **Annexure 20-2**.
- 20.2.4 Within one week of conduct of transect walk, the output of transect shall be disseminated by the PIU indicating how the concerns of community have been incorporated. If due to technical or other reasons, the choices of the community are not incorporated, the reasons for not accepting any suggestion shall be communicated and subsequently alignment shall be finalized. Format for recording the consultation outputs is presented as **Annexure 20-3**.

## 20.3 Pre-Construction Stage

- 20.3.1 Consultations during this stage will be towards seeking consent of landowners for clearance of the Road land width, temporary use of land and material provision for construction.
- 20.3.2 The consultations to be conducted during this stage and aspects to be covered are presented in the individual ECoP prepared for each aspect. PIU will be conducting the consultations towards clearance of the proposed road land width. While Contractor will be conducting consultations

for temporary use of land and for material provision for construction. **Table 20-1** summarizes the consultations to be conducted and provisions made in the individual ECoPs along with the responsibilities.

**Table 20-1: Consultations during Pre-Construction Stage**

Sl.No.	Aspects of Consultation	Desired Outputs	Reference
<b>1</b>	<b>Consultations for Clearance of Road land width</b>		
1.1	Consultation for Relocation of Common Property Resources (CPR)	<ul style="list-style-type: none"> <li>≠ Consent for relocation of CPR</li> <li>≠ Identify area for relocation</li> </ul>	ECoP-2.0
1.2	Relocation of Cultural Properties	<ul style="list-style-type: none"> <li>≠ Consent for relocation of cultural property</li> <li>≠ Discussion on design for relocated structures</li> <li>≠ Identify area for relocation</li> </ul>	ECoP-15.0
<b>2</b>	<b>Consultations for Temporary use of Land</b>		
2.1	Setting up Construction Camp	<ul style="list-style-type: none"> <li>≠ Consent for setting up the camp</li> <li>≠ Terms of use as: free of cost, payment of rent for use or any other</li> <li>≠ Rehabilitation options for the land subsequent to its use</li> </ul>	ECoP-3.0
2.2	Land for Borrowing	<ul style="list-style-type: none"> <li>≠ Consent for use of land for borrowing</li> <li>≠ Location for storage of Topsoil</li> <li>≠ Rehabilitation options for the land subsequent to borrowing</li> </ul>	ECoP-5.0
2.3	Disposal of Wastes	<ul style="list-style-type: none"> <li>≠ Consent for use of land for waste disposal</li> <li>≠ Type of wastes to be disposed</li> <li>≠ Rehabilitation of land subsequent to waste disposal</li> </ul>	ECoP-10.0
2.4	Diversion of Traffic	<ul style="list-style-type: none"> <li>≠ Consent for use of land for temporary traffic diversion</li> <li>≠ Site preparation as removal of topsoil along the route for temporary diversion</li> <li>≠ Rehabilitation of land subsequent to completion of construction in the stretch</li> </ul>	ECoP-14.0
<b>3</b>	<b>Consultations for material extraction</b>		
3.1	Extraction of water	<ul style="list-style-type: none"> <li>≠ Seeking consent on extraction of water</li> <li>≠ Terms of use as: free of cost or payment for water used</li> </ul>	ECoP-8.0
3.2	Borrowing of earth	<ul style="list-style-type: none"> <li>≠ Seeking consent for borrowing</li> <li>≠ Terms of use as: free of cost or payment for earth, depth of borrowing</li> </ul>	ECoP-5.0

## 20.4 Construction Stage

20.4.1 The Site Engineer in charge of the road shall settle any grievances raised by the community during this stage. If grievances remain unaddressed, they shall be referred to the concerned senior officers of PIU (Assistant Engineer and Executive Engineer) and shall be addressed as per the Grievance Redressal Mechanism devised in the **Resettlement Framework**.

20.4.2 The PIU shall consult the community and PRI in identifying people volunteering for Tree plantation. All aspects of tree plantation and maintenance shall be briefed to them towards the end of construction period as per the **ECoP-16.0**, "Tree Plantation".

## 20.5 Post-Construction Stage

20.5.1 The PIU shall conduct consultations with the PRI and community on induced development aspects along the roads constructed. Awareness on impacts likely due to induced development will be generated during the consultations. Measures to be undertaken for its control and avoid encroachments shall be discussed and necessary arrangements shall be notified as per the **ECoP-17.0**, "Induced Development".

## 20.6 Consultation Schedule

Consultations to be conducted at various stages of the project and agencies responsible shall be as per the schedule given in **Table 20-2** below.

**Table 20-2: Schedule of Consultations**

Sl.No	Activity	Main Responsible Agency	Other Agency / Department Involved	Consultation Tool	Stakeholders	Pre-selection	DPR Preparation ( in months)												Post Construction
							1	2	3	4	5	6	7	8	9	10	11	12	13
<b>1</b>	<b>Prioritization</b>																		
1.1	PMGSY road under Core Network	PIU		Dissemination	Pubic														
<b>2</b>	<b>Project Preparation</b>																		
2.1	Project Information & ESMF	PIU	PRI	Dissemination	Village Community														
2.2	Finalization of Alignment	PIU	PRI, RD & FD	Transect Walk	Village Community														
2.3	Follow up	PIU	PRI	Consultation	Village Community														
2.4	Project Planning & Design Stage: Topographical and Other Engineering Surveys	PIU		Consultations	Village Community														
<b>3</b>	<b>Pre-Construction Stage</b>																		
3.1	Clearance of Road land width																		
3.1.1	Relocation of Common Property Resource	PIU	PRI	Consultation	Village Community														
3.1.2	Relocation of Culture Property	PIU	PRI	Consultation	Village Community														
3.2	Temporary Usage of Land																		
3.2.1	Setting up of Construction Camp	Contractor	PRI	Consultation	Property Owner / PRI														
3.2.2	Diversion of Traffic	Contractor	PRI	Consultation	Property Owner / PRI														
3.2.3	Disposal of Wastes	Contractor	PRI	Consultation	Property Owner / PRI														
3.3	Material Extraction																		
3.3.1	Borrowing of Earth	Contractor	PRI	Consultation	Property Owner / PRI														
3.3.2	Extraction of Water	Contractor	ID, GWB	Consultation	Property Owner / PRI														
<b>4</b>	<b>Construction Stage</b>																		
4.1	Redressal of Grievances	Contractor	PIU	Consultation	Property Owner / Community														
<b>5</b>	<b>Post Construction Stage</b>																		
5.1	Identification for Voluntary Tree Plantation	PIU	PRI	Consultation	Village Community														
5.2	Induce Development Aspect	PIU	PRI	Consultation	Village Community														



## References

---

1. Rural Road Manual, IRC: SP: 20-2002, Indian Road Congress (IRC) Publications, 2002
2. Hill Road Manual, IRC: SP: 48-1998, Indian Road Congress (IRC) Publications, 1998
3. Keller, G.; Sherar J.; Best Management Practice Field Guide, Low-Volume Roads Engineering, US Agency for International Development (USAID), Washington, DC. May, 2003.
4. General Conditions of Contract for Central P.W.D. Works, A Government of India Publication, 2003
5. Utilization of Fly Ash, Ministry of Environmental and Forest (MoEF) Notification, S.O. 1164 (E), The Gazette of India, Extraordinary Part II, Section 3, Sub-section (ii), Ministry of Environment and Forest, 5<sup>th</sup> November, 2002.
6. Steel Slag, Turner-FairBank Highway Research Center (online). [Cited 24<sup>th</sup> September 2003] Available from World Wide Web: <http://www.tfhr.gov/hnr20/recycle/waste/ssa2.htm>.
7. Siddharth, P., Gainful Utilization of Marble Waste, An Effort towards protection of Ecology & Environment (Online), [Cited 25<sup>th</sup> September 2003] Available from World Wide Web: <http://www.cdos-india.com/papers/18%20-%20Gainful%20Utilization%20of%20Marble%20Wast%20-%20Siddharth%20Pareek.doc>
8. Recommended Practice for Borrow Pits for Road Embankment Constructed by Manual Operation, IRC: 10-1961, Indian Road Congress (IRC) Publication, 1961
9. Permanent Vegetation, CODE 880, Illinois Urban Manual Practice Standard, (online), [Cited on 10<sup>th</sup> October 2003], Available from World Wide Web: <http://www.il.nrcs.usda.gov/engineer/urban/Standards/urbst880.htm>
10. Chilibeck, B., Chislett, G., Norris G., Land Development Guideline for the Protection of Aquatic Habitat, The Habitat Management Division of Fisheries and Ocean and The Integrated Branch of The Ministry of Environment, Land and Parks, Government of Canada, September 1993.(Online), [Cited on 19<sup>th</sup> September 2003], Available from the Worldwide Web: [http://collection.nlc-bnc.ca/100/200/301/dfo-mpo/land\\_development\\_guidelines/165353.pdf](http://collection.nlc-bnc.ca/100/200/301/dfo-mpo/land_development_guidelines/165353.pdf).
11. Water, Clause 1010, Materials for Structures, Section 1000, Specification for Road and Bridge Works (Fourth Revision), Ministry of Road Transport and Highways, Indian Road Congress (IRC) Publications, 2001.
12. Code of Practice for Plain and Reinforced Concrete (Fourth Revision), IS: 456-2000, Indian Standards, 2000.
13. Drinking Water (First Revision) (Amendment 1), Reaffirmed 1993, IS: 10500-1991, Indian Standards, 1993.
14. Construction/Demolition Waste Recycling and Disposal, Saskatchewan Environment, Environmental Protection Branch, SWANA Publication #GR-REC 300, 1993, SENES Consultants Ltd., Environment Canada, December 1993 (Online) [Cited on 21<sup>st</sup> September 2003], Available on Worldwide Web: <http://www.se.gov.sk.ca>

15. Guidelines for The Design of Small Bridges and Culverts, IRC: SP: 13-1973, Indian Road Congress (IRC) Publication, 1973.
16. Guidelines on Supplemental Measures for Design, Detailing & Durability of Important Bridge Structures, IRC: SP: 33-1989, Indian Road Congress (IRC) Publication, 1973.
17. Recommended Practice for Sight Distance on Rural Highways, IRC: 66-1976, Indian Road Congress (IRC) Publication, 1976.
18. Guidelines on Road Drainage, IRC: SP: 42-1979
19. Manual on Landscaping of Roads, IRC: SP: 21-1979, Indian Road Congress (IRC) Publication, 1979
20. Role of Gram Panchayats in Regulating Development along Roads, Post 73<sup>rd</sup> Constitutional Amendment, 1992, Constitution of India.
21. Pollution Control Acts, Rules and Notifications Issued Thereunder, Central Pollution Control Board (CPCB), September, 2001. Available on Worldwide Web: <http://www.envfor.nic.in/legis/legis.html> - B

**ANNEXURE**

---



## ANNEXURE 1-1 SCREENING OF SUB-PROJECTS

A screening and review process for identification of sensitive sub-projects with respect to environmental/social issues has been worked out. The screening exercise shall be carried out by the PIUs prior to initiation of the DPR activities. The **screening exercise** shall be a useful **tool to identify the environmental and social issues**, and thereby integrate them into the project preparation, and **not as an exclusion criterion** for avoiding environmental and social impacts. The screening criteria includes:

Environmental factors, including,

- ## Sensitive areas, natural habitats, protected areas
- ## Felling of trees outside the protected areas
- ## Clearance of vegetative cover
- ## Loss of productive agricultural land
- ## Cuts across perennial streams or surface water bodies
- ## Vulnerability to natural hazards, land slides/slips and,
- ## Environmental features as marshy areas, sand dunes etc

Social factors, including,

- ## Land availability
- ## Loss of structures
- ## Loss of livelihood
- ## Impacts on Indigenous population
- ## Impacts on common property resources, and,
- ## Demand from communities for the road.

The screening shall enable categorization of sub-projects based on their environmental / social sensitivity as follows:

Sub-projects, wherein no significant adverse environmental/social impacts are expected, and

- ## (i) The environmental impacts will be of the type normally associated with standard rural road construction. The measures suggested in the ECoP shall be adequate to address the general environmental issues likely in these sub-projects.
- ## (ii) The extent of social impacts is minimal. The requirement for land width accretion is not significant and there is no impact on structures or loss of livelihood. Any extra land take in the sub-projects for the proposed improvements shall be through a transparent process of voluntary land donation as laid down in the R&PF. Resettlement impacts of the vulnerable EPs shall be addressed through the entitlement provisions suggested. The documentation of the addressal of the social issues shall be included in the DPR of the sub-projects, as specified in the R&PF. In such projects, the level of documentation of the environmental and social issues shall be as laid down in the **ECoP-1.0**, "Project Planning and Design" and the R&PF.

Sub-projects, wherein there is a potential for significant adverse environmental /social impacts,

- ## (i) There is a likelihood of adverse impacts requiring specific interventions such as roads passing through forestlands, sanctuaries etc, and thereby requiring additional environmental analysis. In such cases, an EMP as outlined in the **ECoP 19.0**, "Natural Habitats" shall be prepared as part of the DPR. The following aspects shall be considered as triggers for the preparation of EMP, (a) Impacts on natural habitats, (b) Vulnerability to natural hazards, land slides/slips. In addition to the preparation of the EMP for such projects, the PIU shall undertake the particular road improvement in compliance with the statutory provisions for Environmental Clearances as applicable.

- ## (ii) Prior to initiation of the DPR preparation, it is revealed that there is a likelihood of significant resettlement or the sub-project involves loss of structures / livelihood and there is a resentment of the communities towards the process of voluntary land donation for the project. In such cases, the PIU shall work out alternative alignments to minimise the social impacts. Sub-projects where there no scope exists for addressing the resettlement impacts through any of the mechanisms suggested in the R&PF shall not be taken up during that particular year. For such roads, the PIU shall decide not to go forward with the proposed road improvement through a written communication to the PRI stating the reasons, and no further analysis or investigation will ensue. Such roads will be taken up in subsequent phases of the project, only after these issues are resolved by the communities / PRI and there is a formal demand for the project to the PIU from the PRI.

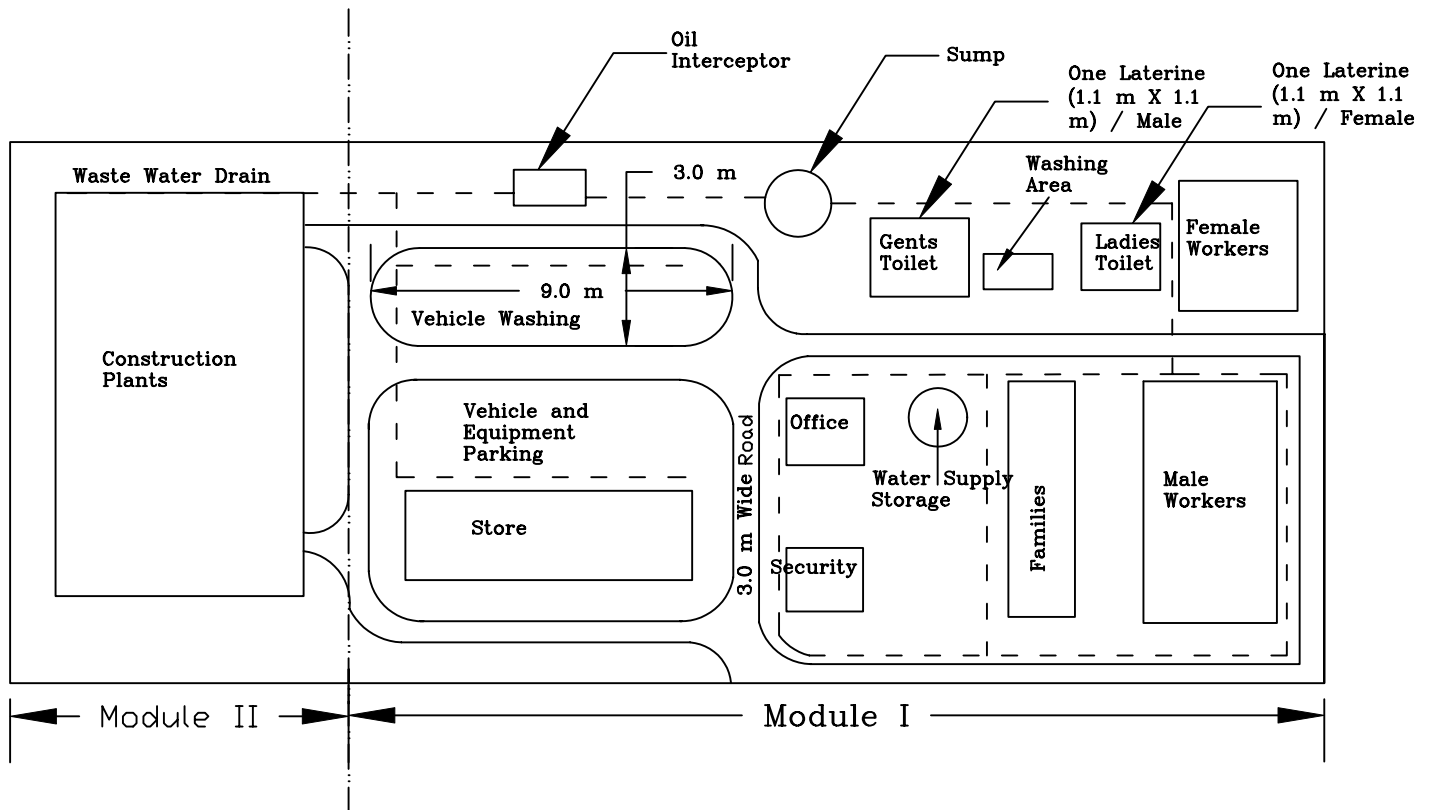

**NOTE:**

Incase of Centralized Construction Camp Module II shall be added

Construction Camp shall be about 3000 sq m for 60 workers

Floor Area shall be calculated at the rate of 2.7 sq m / worker

Cooking Place Area shall be 1.8 m X 1.5 m in front of each unit

Material Use for construction of camp:

1. Sundried or Burnt Brick laid in mud mortar shall be used for construction of wall.

2. Floor may be kutchha but plastered with mud gobi and shall be atleast 15 cm above ground level.

Open space shall be atleast 7.2 m between the row of huts or reduced to 6.0 m according to the availability of site.

Water Storage Capacity shall be at the rate 135 l per worker and in arid areas 110 l per worker

Sump of capacity 1.3 times of maximum waste water discharge per day shall be constructed

Construction Plant (include WMM plant, Hot-mix plant, Generator, Aggregate Stockpile, Bitumen storage tank, Cement storage, Oil & Grease) of about 5500 sq m shall be constructed

TITLE  
**CONCEPTUAL LAYOUT OF CONSTRUCTION CAMP**

Client:-  
MINISTRY OF RURAL DEVELOPMENT (MoRD)

PROJECT  
**PRADHAN MANTRI GRAM SADAK YOJANA**

ANNEXURE  
3-1

Date:-  
03-02-04

Scale:-  
NOT TO SCALE



Consultant:-  
LEA ASSOCIATES SOUTH ASIA PVT. LTD.  
(LASA) NEW DELHI



**MEMORANDUM OF UNDERSTANDING  
FOR  
SUPPLY OF QUARRY OVERBURDEN**

This Memorandum of Understanding (herein after referred as "MoU") is made on \_\_\_\_ day of (Month), (Year) corresponding to Saka Sambat \_\_\_\_ day of (Month), (Year)

Between 4

Shri \_\_\_\_\_, owner of (Name of Quarry), (Licensed Number) (Name of Village, Block, City), (hereinafter referred as "First Party")

And

M/S \_\_\_\_\_, (Registration Number) incorporated under the Companies act \_\_\_\_ (hereinafter referred as "Second Party"), appointed by the Program Implementation Unit (herein after referred as "PIU") of the behalf of Government of \_\_\_\_\_ for the construction of PMGSY Road.

By this MoU,

**The First Party Agrees:**

1. To supply \_\_\_\_\_ cum of quarry overburden of type (Soil / Mix of Soil and Weathered Stone / Weathered Stone) for the construction of PMGSY Road in the village \_\_\_\_\_, block \_\_\_\_\_, district \_\_\_\_\_, state \_\_\_\_\_.
2. Not to claim any cost against above said quarry overburden.

**Second Party Agrees:**

1. To utilize above mentioned quarry overburden for sole purpose of construction of PMGSY Road.
2. To bear the transportation cost of above mentioned quarry overburden.

**Term of MoU**

This MoU shall commenced on the date of its signing and shall remain in force for a period till the mentioned quantity of overburden is met. Thereafter the MoU shall be deemed terminated by lapsing.

**Termination**

The second party can terminate the MoU by giving one-week notice if quality of the overburden does not conform to the engineering specification.

The first party can terminate the MoU, by specifying the reason in written and giving two-week notice to the second party.

The parties hereto have signed this MoU on the date and the year above written.

\_\_\_\_\_

(Signature of First Party)

\_\_\_\_\_

(Signature of Second Party)

**CERTIFICATE FOR COMPLETION  
OF  
RECLAMATION**

This certificate for completion is made on \_\_\_\_\_ day of \_\_\_\_\_ 2004 corresponding to Saka Sambat \_\_\_\_\_ day of \_\_\_\_\_ 2004 by Shri \_\_\_\_\_ son of \_\_\_\_\_ resident of village \_\_\_\_\_, block \_\_\_\_\_, district \_\_\_\_\_, state \_\_\_\_\_ (hereinafter referred to as "Owner")

**The Owner hereby declares that:**

1. Have transferable rights of \_\_\_\_\_ acre of land bearing khasra No. \_\_\_\_\_ in village \_\_\_\_\_ block \_\_\_\_\_, tehsil \_\_\_\_\_, and district \_\_\_\_\_.
2. Certified that M/S \_\_\_\_\_, (Registration Number) incorporated under the Companies act \_\_\_\_\_ (hereinafter referred to as "Contractor") had satisfactorily completed the reclamation of \_\_\_\_\_ acre of land utilized for \_\_\_\_\_ as per provision.

\_\_\_\_\_

(Signature of Owner)

**LETTER OF CONSENT  
FOR  
USAGE OF WATER FOR CONSTRUCTION**

This Letter Of Consent (herein after referred to as "LoC") is made on \_\_\_\_\_ day of \_\_\_\_\_ 2004 corresponding to Saka Sambat \_\_\_\_\_ day of \_\_\_\_\_ 2004

Between

Shri \_\_\_\_\_ Sarpanch of village \_\_\_\_\_, block \_\_\_\_\_, district \_\_\_\_\_, state \_\_\_\_\_ (hereinafter referred to as "PRI")

Or

Shri \_\_\_\_\_ son of \_\_\_\_\_ resident of village \_\_\_\_\_, block \_\_\_\_\_, district \_\_\_\_\_, state \_\_\_\_\_ (hereinafter referred to as "Owner")

And

M/S \_\_\_\_\_ (Registration Number) incorporated under the Companies act \_\_\_\_\_ (hereinafter referred to as "Contractor").

By this LoC,

**The Owner / PRI hereby declares that:**

1. Have no objection on usage of \_\_\_\_\_ volume of water for the construction of PMGSY Road
2. Shall claim the sum of \_\_\_\_\_ only as compensation, incase of damage to the source of water or its utility
3. Shall charge \_\_\_\_\_ per Kiloliter incase of
 

ÿ	Extraction of water irrespective of quantity of extraction	<u>Tick which ever is agreed upon</u>
ÿ	Over extraction of water (above the quantity agreed in declaration 1.	
4. Shall be liable for all losses or damage caused to any individual/organization/community for suppressing any information in this respect

**Term of LoC**

This LoC shall be effective from the date of its signing and shall remain in force for a period of \_\_\_\_\_ Year. Thereafter the LoC shall be deemed terminated by lapsing.

The parties hereto have sign this LoC on the date and the year above written

\_\_\_\_\_

(Signature of Owner / PRI)

\_\_\_\_\_

(Signature of Contractor)

\_\_\_\_\_

(Signature of Witness on owner/PRI side)

\_\_\_\_\_

(Signature of witness on Contractors side)

**NO OBJECTION CERTIFICATE  
FOR  
TEMPORARY USAGE OF LAND**

This No Objection Certificate (herein after referred to as "NOC") is made on \_\_\_\_\_ day of \_\_\_\_\_ 2004 corresponding to Saka Sambat \_\_\_\_\_ day of \_\_\_\_\_ 2004

Between

Shri \_\_\_\_\_ son of \_\_\_\_\_ resident of village \_\_\_\_\_, block \_\_\_\_\_, district \_\_\_\_\_, state \_\_\_\_\_ (hereinafter referred to as "Owner")

And

M/S \_\_\_\_\_ (Registration Number) incorporated under the Companies act \_\_\_\_\_ (hereinafter referred to as "Contractor").

By this NOC,

**The Owner hereby declares that:**

1. Has transferable rights of \_\_\_\_\_ acre of land bearing khasra No. \_\_\_\_\_ in village \_\_\_\_\_ block \_\_\_\_\_, tehsil \_\_\_\_\_, and district \_\_\_\_\_.
2. Have no objection on temporary disposal of construction waste / borrowing / if any other specify \_\_\_\_\_ for PMGSY Road Construction within the said boundaries: \_\_\_\_\_ (North Side), \_\_\_\_\_ (South Side), \_\_\_\_\_ (East Side), \_\_\_\_\_ (West Side)
3. Above said land shall only be utilized for the said purpose only
4. No hazardous waste / material dumping or activities involving hazardous material shall be done within the said boundary.
5. Shall claim the sum of \_\_\_\_\_ only as compensation, incase reclamation of above said land not being undertaken within \_\_\_\_\_ (day / month / year) from the date of signing of NOC.

Or

Incase of violation of above mention clauses.

6. Shall be liable for all losses or damage caused to any individual/organization/community for suppressing any information in this respect

**The Contractor hereby commits that:**

1. Not to carry out any activity beyond the specified boundary, as specified in the boundary above.
2. To reclaim the plot of land within \_\_\_\_\_ (day / month / year) from the date of signing of NOC as per Reclamation Plan approved by the PIU, (Name of the PIU).
3. Shall compensate above-mentioned sum to the owner incase above mention time frame is not met.

**Term of MoU**

This MoU shall be effective from the date of its signing and shall remain in force for a period of \_\_\_\_\_ Year. Thereafter the MoU shall be deemed terminated by lapsing.

The parties hereto have sign this MoU on the date and the year above written

\_\_\_\_\_

(Signature of Owner)

\_\_\_\_\_

(Signature of Contractor)

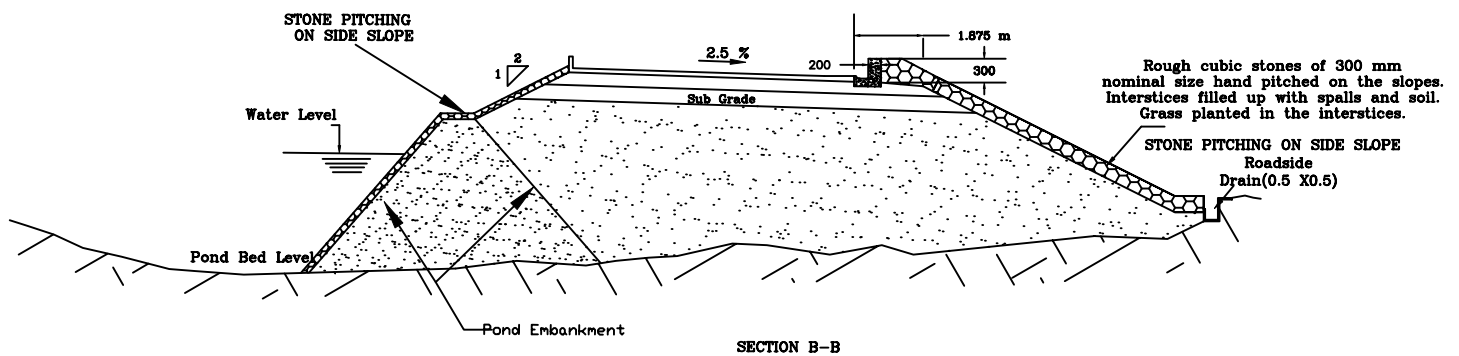
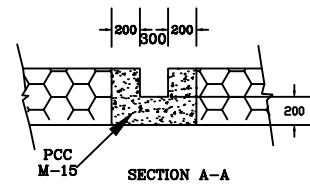
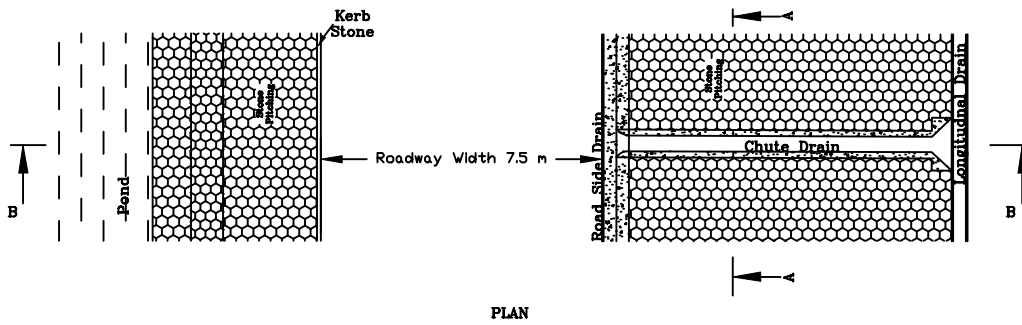

ROAD ON POND EMBANKMENT

<b>TITLE</b> <b>WATERBODY REHABILITATION</b>					Client:- <b>MINISTRY OF RURAL DEVELOPMENT (MoRD)</b>
<b>PROJECT</b> <b>PRADHAN MANTRI GRAM SADAK YOJANA</b>		<b>ANNEXURE</b> 11-1	<b>Date:-</b> 03-02-04	<b>Scale:-</b> NOT TO SCALE	
<b>Consultant:-</b> <b>LEA ASSOCIATES SOUTH ASIA PVT. LTD.</b> (LASA) NEW DELHI					



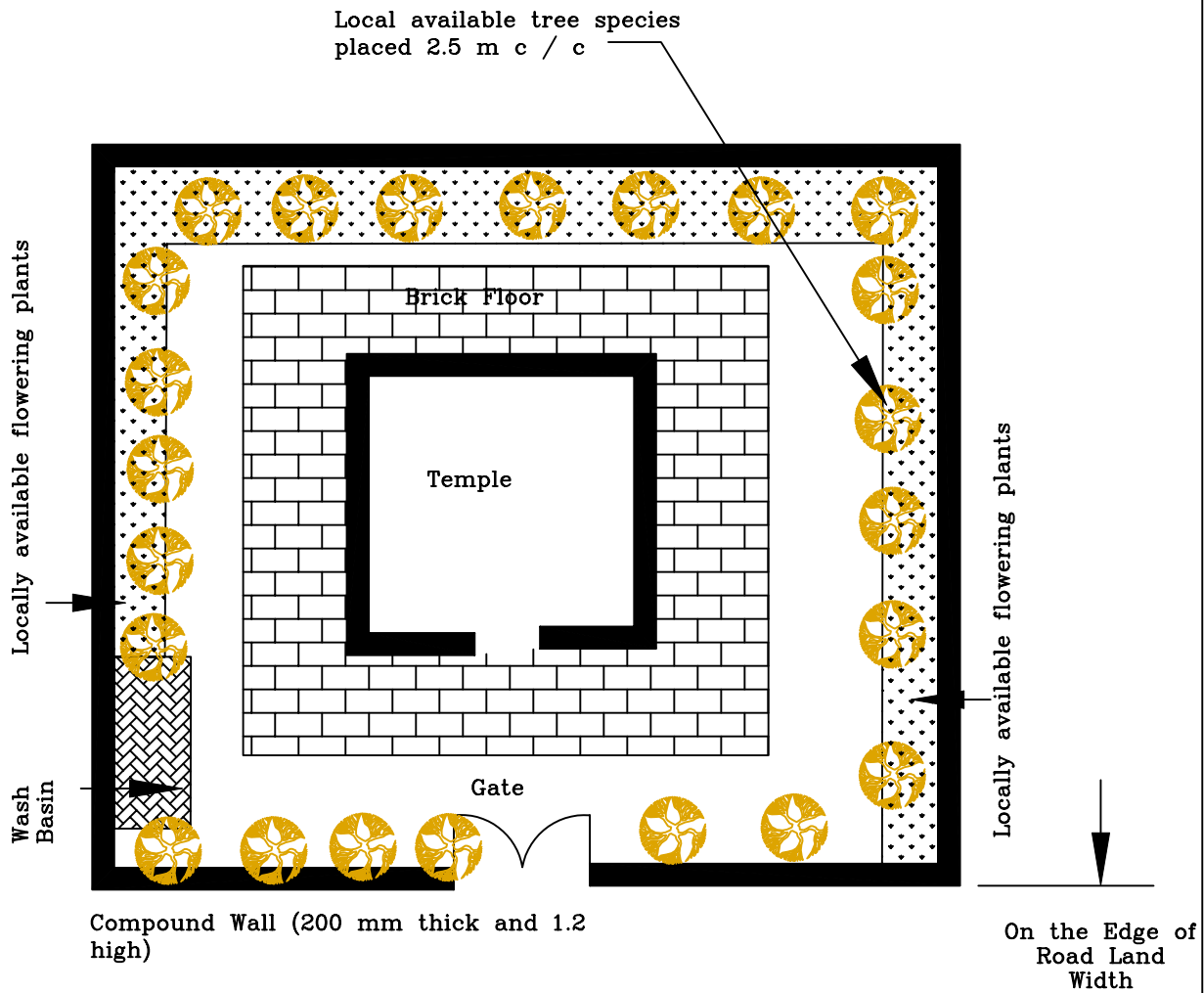

### Sample BoQ for Cultural Property

Built Up Area Sq m 9  
Plot Area Sq m 165

Sl No	Item	Unit	Quantity
1	Dressing Area	Sq m	156
2	Brick Floor	Sq m	40
3	Tree and Flower Plantation		
4	Grass Area	Sq m	52.5
5	No of trees	No	11
6	Compound Wall		
	(I) Brick Work	Cu m	8.775
	(II) Excavation	Cu m	10.53

TITLE  
**RELOCATION OF CULTURAL PROPERTY**

Client:-  
MINISTRY OF RURAL DEVELOPMENT (MoRD)

PROJECT  
**PRADHAN MANTRI GRAM SADAK YOJANA**

ANNEXURE  
15-1

Date:-  
03-02-04

Scale:-  
NOT TO SCALE



Consultant:-  
LEA ASSOCIATES SOUTH ASIA PVT. LTD.  
(LASA) NEW DELHI



**MEMORANDUM OF UNDERSTANDING**  
Between  
**PUBLIC WORK DEPARTMENT (PWD), GOVERNMENT OF (Mention State)**  
**STATE FOREST DEPARTMENT**  
And  
**PANCHAYAT RAJ INSTITUTION (PRI)**

This MEMORANDUM OF UNDERSTANDING (hereinafter referred to as “MoU” is made on the \_\_\_\_ day of (Month), (Year) for (Name of PMGSY Road) of length \_\_\_\_ km.

Between

Public Work Department (PWD), Government of (Mention State)

State Forest Department

And

Panchayat Raj Institution (PRI)

By this MoU, PRI and State Forest Department agree to undertake roadside tree plantation along the PMGSY Road, in accordance to the commitments cited below:

**STATE FOREST DEPARTMENT HERE BY COMMITS:**

- i. The alignment shall be finalized after transect walk in case it passes through Forest area.
- ii. Forest Department agrees to depute forest ranger to provide suggestions to design modification and to help in identification of species of trees to be felled if any. This shall help in drawing up tree plantation strategy. In case the alignment passes through forest areas, Forest Ranger shall provide information on presence of any rare/endangered species as per the Red Data Book.
- iii. To assist PIU for developing roadside tree plantation strategy on the PMGSY road in consultation with the community.
- iv. To supply saplings to the PRIs / Community from the forest nurseries.
- v. To provide training to PRI / Community for:
  - a. Seeding procedure
  - b. Fertilizing and watering of trees
  - c. Maintaining of roadside tree that include (i) cutting/lopping branches and (ii) Weed cutting.
- vi. To depute Forest Ranger to monitor the healthy survival of trees (refer Annexure I for monitoring format) and prepared monitoring report at every three months incorporating gaps and suggestions. The copy of the same shall be sent to DFO and PIU.

PANCHAYAT RAJ INSTITUTION (PRI) HERE BY COMMITS:

- i. To plant saplings provided by the state forest department as per roadside plantation strategies.
- ii. To undertake training program organized by the forest department for planting and maintaining the trees.
- iii. To undertake maintenance of planted trees with its own funds. The maintenance shall include:
  - a. Fertilizing and watering the trees during initial period of two to three years.
  - b. Spraying of insecticides / pesticides
  - c. Cutting/lopping branches up to a height of 2.5m above ground level to ensure visibility.
  - d. Removal of dead wood from the roadway and storing away from roads, and
  - e. Weed cutting from shoulders and keeping the shoulders free from any growth of vegetation
- iv. To plant replacement saplings where the survival rate is less than 80 %
- v. To prepare roadside tree plantation inventory for every kilometer length for PMGSY Road including rate of survival after every three month. The copy of the same shall be submitted to PIU.

This MoU shall be valid for a period of two year from the date of its signing and may be renewed as mutually agreed upon between PWD, PRIs and Forest Department.

The terms and conditions set out in this MoU shall supersede all earlier communication, if any, exchanges for the purpose.

Dated: \_\_\_\_\_

Signature:

\_\_\_\_\_  
Executive Engineer  
(PIU)

\_\_\_\_\_  
Sarpanch  
(PRI)

\_\_\_\_\_  
District Forest Officer  
(Forest Department)

### Annexure 20-1: Information Dissemination Formats

Project Stage	Information to be Disseminated	How to Disseminate	Location	Responsible Agency	Target Group
<b>Prioritization</b>					
After approval of Core Network	Details of Core Network	Display of list and maps at Gram Panchayat Office <b>(Format 1)</b>	Gram Panchayat Office	PIU	Village Community
<b>Planning</b>					
Prior to finalization of alignment	Overview of project with salient features, Implementing Agency	Distribution of Brochures <b>(Format 2)</b>	Village Chaupal/Haat, Local Newspaper	PIU	Village Community
Prior to Transect Walk		Public Announcements <b>(Format 3)</b> Pamphlets/Posters <b>(Format 4)</b>	Village Chaupal/Haat	PIU	Village Community
During Transect Walk	Guidance Note for Transect walk	Pamphlets/Posters <b>(Format 5)</b>	Village Chaupal/Haat	PIU	Village Community
After finalization of alignment and minimization of impacts	Outputs from transect walk including modifications community suggestions, List of impacts & PAPs	Display of Transect Walk Maps and List of issues <b>(Format 6)</b> Pamphlet/Display of list of PAPs <b>(Format 7)</b>	Village Chaupal, Haat	PIU	Village Community, PAPs
Prior to voluntary land donation	Process of Voluntary Donation & Entitlements	Notices to Individual Landowners/PAPs <b>(Format 8)</b> Notice to Eligible PAPs <b>(Format 9)</b>	Village Chaupal, Haat, List at Gram Panchayat Office	PIU	PAPs & Eligible PAPs
<b>Implementation</b>					
Prior to initializing construction works	Sub-Project Details	Pamphlets/Announcement/Notice Boards <b>(Format 10)</b>	Village Chaupal, Haat, Onsite Information Boards	PIU	Community, PAPs

**Format 1 Detail of Core Network along with Map** (After approval of Core Network)

**State:**

**District:**

Block Name & Code	Corridor Name	Link Route/ No.	Village/s Name & Code			Whether Connected/Not Connected	Type of Road Work	Population			Estimated Cost (Rs. Lakhs)	Estimated Length (kms)
			From	To	Beneficiary Village			Total	SC	ST		

The map for the Core Network should clearly communicate

- Q Administrative Boundaries (District/Block/Tehsil/Village)
- Q Link Route and Length
- Q Name of connected habitation/s

Responsible Agency/Person: PIU (EE/SE), District Panchayat (Zila Pradhan), Gram Panchayat (Sarpanch and other members)

**Format 2 Project Details Brochure** (Prior to initiating PMGSY roadwork)

Responsible Agency/Person: PIU (AE/JE), Gram Panchayat (Sarpanch and other members)

**INFORMATION ABOUT IMPLEMENTING AGENCIES**

**Department :** \_\_\_\_\_

Address : \_\_\_\_\_ Tel.: \_\_\_\_\_ E-mail \_\_\_\_\_

Contact Person \_\_\_\_\_

Department : \_\_\_\_\_

Address \_\_\_\_\_

Contact Person \_\_\_\_\_ Tel. No. \_\_\_\_\_

Principal Technical Agency: \_\_\_\_\_

Contact Person \_\_\_\_\_ Tel. No. \_\_\_\_\_

State Technical Agency: \_\_\_\_\_

Contact Person \_\_\_\_\_ Tel. No. \_\_\_\_\_



PRADHAN MANTRI GRAM SADAK YOJANA

**INFORMATION BROCHURE**



*What is PMGSY?*

*Why are all weather roads being built?*



***What is PMGSY?***

PMGSY or Pradhan Mantri Gram Sadak Yojana is a Central Government project to provide road connectivity to villages with population of 500 persons or more in the rural areas by 2007. In desert, hill and tribal areas, the villages with population 250 or more will be connected.

***Why are all weather roads being built?***

Rural road connectivity plays a key role in securing poverty alleviation by providing easy access to marketing centers for agricultural produce at lower transportation cost resulting in higher price realization and consequently increasing rural income. It further increases access to education, healthcare, employment opportunities and improving standard of living of the rural population.

*Where are these roads being built?*

*Who will build these roads?*

*What is the meaning of PIU?*



***Where are these roads being built?***

In the state, the Govt would finance the proposed PMGSY works through the World Bank in .....districts. The villages with population of 500 or more will be connected through roads. In desert, hill and tribal areas, the villages with population 250 or more will be connected.

***Who will build these roads?***

In the state, the ..... (Department) is implementing PMGSY. The ..... (Department) has set up a Project Implementing Unit (PIU) for this purpose at the district level.

***What is the meaning of PIU?***

PIU is the short name of "Programme Implementing Unit". This includes Senior officers from ..... (Department), other officers, engineers etc. PIU will work in consultation with PRI (Panchati Raj Institutions).

*Who will finance this project?*

*What is World Bank?*



***Who will finance this project?***

The Govt would finance the proposed PMGSY works through the World Bank. In the .....districts of state the project is being implemented with loan from World Bank .

***What is World Bank?***

World Bank is an international organization, which gives loan for development purpose to the governments all across the world.

*How are the project roads selected?*

*How to get the core network map?*

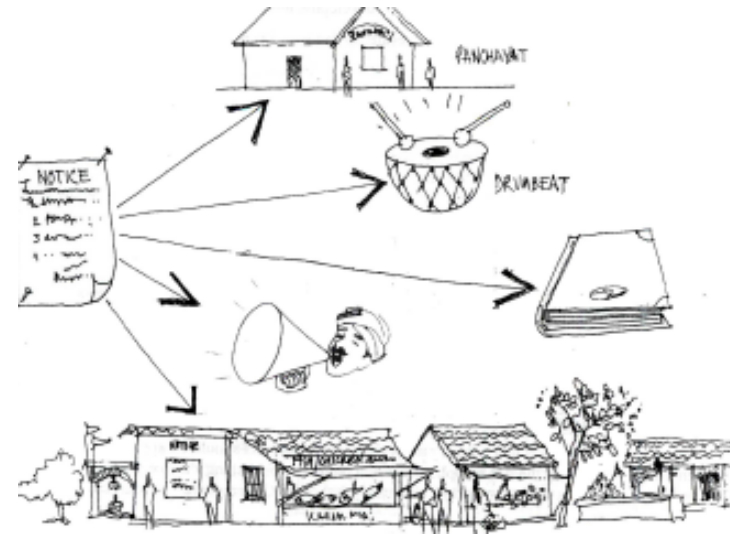

***How are the project roads selected?***

The selection of roads for new construction/ up gradation shall be from the core network. A Core Network is the minimal network of roads essential to provide basic access to essential social economic services to all eligible habitations in the selected areas through at least single all-weather road connectivity.

***How to get the core network map?***

Copies of the Core Network are available for the public at the Zila Panchayat offices. Salient features of the finalized core network will be displayed at the notice boards of the District Panchayat and the concerned Gram Panchayats.

*What are the prerequisites for building the roads?*

*Donation of Land*

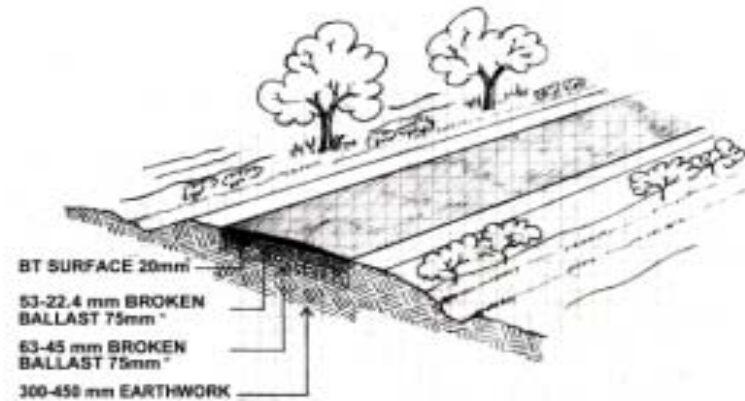

\* This is a typical Cross Section. The actual thickness of layers varies and would depend upon pavement design based on location of road, soil conditions, and other parameters.

***What are the prerequisites for building the roads?***

It is necessary to have sufficient land for building the road. In case of sharp curves extra land may be required to ensure the safety of the road users.

***Donation of Land***

In case the land is required, the villagers will have to donate part of their land for the project.

*Which land will be required?*

*What are the possible types of impact?*

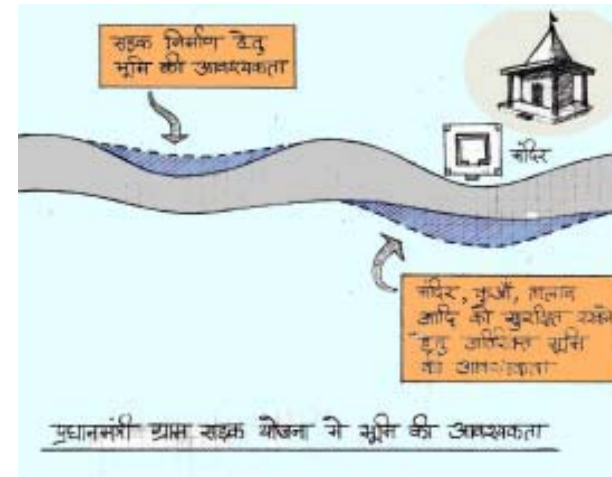

**Which land will be required?**

The land required for the project will be nominal. Wherever the revenue tracks already exist, it will be converted into all weather road. Thus the impact on land, houses, shops etc will be minimal. Extra land will be required where the existing revenue track is narrow or there is need to improve the curve.

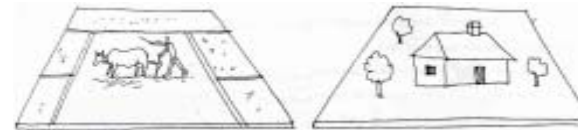

**What are the possible types of impact?**

- Land may be required for road building or widening,
- Farming, shops etc may be required to shift away at the place where the road is to be built,
- If house is located at the place where road is to be built, it may have to be shifted.

*You are eligible for assistance if !*



**You are eligible for assistance if :**

*You belong to :-*

- BPL households (with a valid proof), as per the State poverty line for rural areas;
- Other eligible categories:
  - (1) Women headed households with women as sole earner
  - (2) Scheduled Caste/Scheduled Tribe and
  - (3) Handicapped person,

*and you are subjected to any of the following impacts;*

- o Loses considerable amount of land (more than 10% /20% of the total land holding),
- o Loses shelter and,
- o Loses source of livelihood.

## *Suggested Measures for Addressing Various Impact Categories*

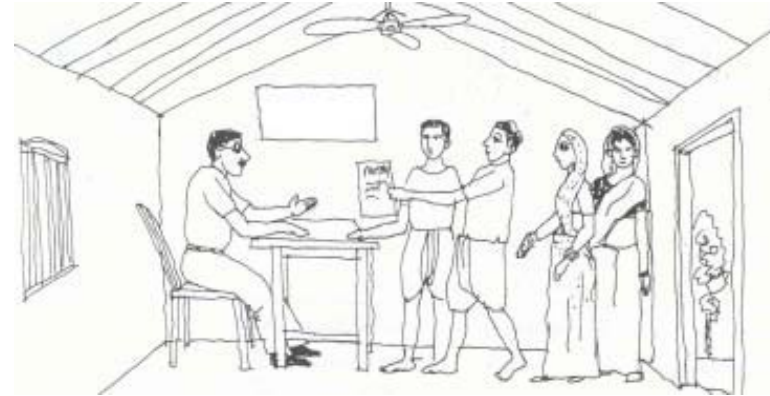

### **Suggested Measures for Addressing Various Impact Categories**

- **Land:** Assistance/Support by the community only for vulnerable groups through: (i) Alternate land sites provided by GP/community (ii) Assistance or support by community and Panchayat and (iii) Inclusion as beneficiaries in Rural Development (RD) programs if eligible.
- **Structures:** Assistance/Support for asset creation by community and Panchayat (or) Inclusion of PAPs losing shelter as beneficiaries in RD programs if eligible.
- **Livelihood:** Inclusion as beneficiaries in RD programs if eligible.
- **Common Property Resources:** GP/community with technical inputs from PIU either relocate or construct assets; Consultations with the concerned sections of the community in case of grazing land etc
- **Non-titleholders:** Advance notice to removal of assets/standing crops and subsequent clearance; Involvement of GP/community in sensitisation and clearance of encroachments

## *How community can contribute?*



### ***How community can contribute?***

The project encourages community involvement to make them accountable in the success of the entire project. The community will participate directly or in coordination with PRIs for the following:

- Identification and finalization of core network
- Finalization of alignment
- Facilitate identification of issues and concerns
- Suggest measures for mitigating impacts including impacts on eligible vulnerable groups
- Redressing grievances at individual / community level
- Providing assistance to the contractor to ensure speedy implementation.

*What happens when there is resentment from the communities?*

### *PMGSY and Conservation of Environment*



#### ***What happens when there is resentment from the communities?***

The roads under PMGSY will be built to connect villages where the communities need them. The PIU shall not take up those roads (in that particular year) where the local population is apprehensive to the implementation of the Resettlement Framework. Such projects will be taken up at a later stage, only after the communities / PRIs work out suitable mechanisms at the village level to resolve issues pertaining to land take.

#### ***PMGSY and Conservation of Environment***

PMGSY aims for rural roads construction with a minimum impact on the environment. To avoid adverse environmental impacts, issues have been considered at each project implementation stage to guide planning, design, construction and maintenance of PMGSY roads. Detailed guidelines named ECoP are prepared for this purpose. The information on this could be obtained from the PIU.

## *Addressal of Public Grievances*



### **Addressal of Public Grievances**

During the Planning stage a group of people will conduct Transect Walk. During the walk, the members of PIU will talk to the villagers, give them information, receive information from them and will try to understand their problems. Besides this they will also take suggestions for solutions to above problems.

The PIU to intimate the PRI at least a week prior to the transect walk. The intimation to the public shall be in the form of a formal notice at the Village Panchayat building. The information will include the date, time and place of the transect walk.

*What will happen if there are grievances even after the Transect Walk?*



***What will happen if there are grievances even after the Transect Walk?***

The Land Management Committee shall act as the village level Grievance Committee, and will meet once in a month till DPR preparation and quarterly after initiation of the construction work for addressing grievances till the construction is completed. Residual grievances will be addressed through a Grievance Redressal Committee at the district level, comprising (i) Executive Engineer of the PIU, (ii) Sub-Divisional Magistrate (iii) Member of Zila Parishad, and (iv) Member of Land Management Committee of the GP. Representative of PAPs will be invited to be present during the proceedings of grievance redressal. This committee will solve the grievances, which could not be solved at the village level.

## *How to get information about the project*

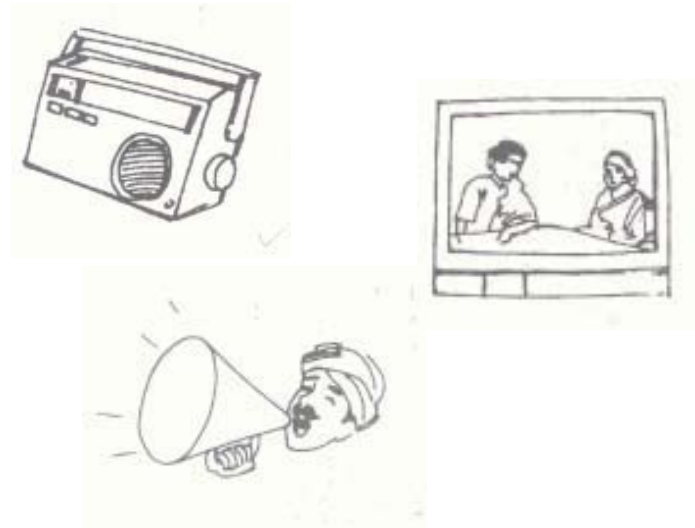

### **How to get information about the project**

The PIU will give information at every stage of the project. The information about the plan of road could be obtained from the Gram Panchayat. The Gram Panchayat will maintain a list of all the documents related to the project. Copy of which could be obtained from the panchayat office. After the finalisation of alignment the information could be obtained from both Village Panchayat and District Panchayat.

The official web site of the PMGSY [www.pmgysy.nic.in](http://www.pmgysy.nic.in) provides the detailed project information at the national, state and district levels.

**Format 3 Public Announcements** (Prior to finalization of alignment/transect walk)

- Q What is the Project and its salient features
- Q Benefits
- Q Which Agencies are involved
- Q What if resentment from community
- Q Need for additional land through Voluntary Land Donation
- Q Likely Impacts and Entitlements
- Q Date of Transect Walk
- Q Alignment Details along with map of alignment displayed
- Q Contact Person and Address (PIU and PRI)

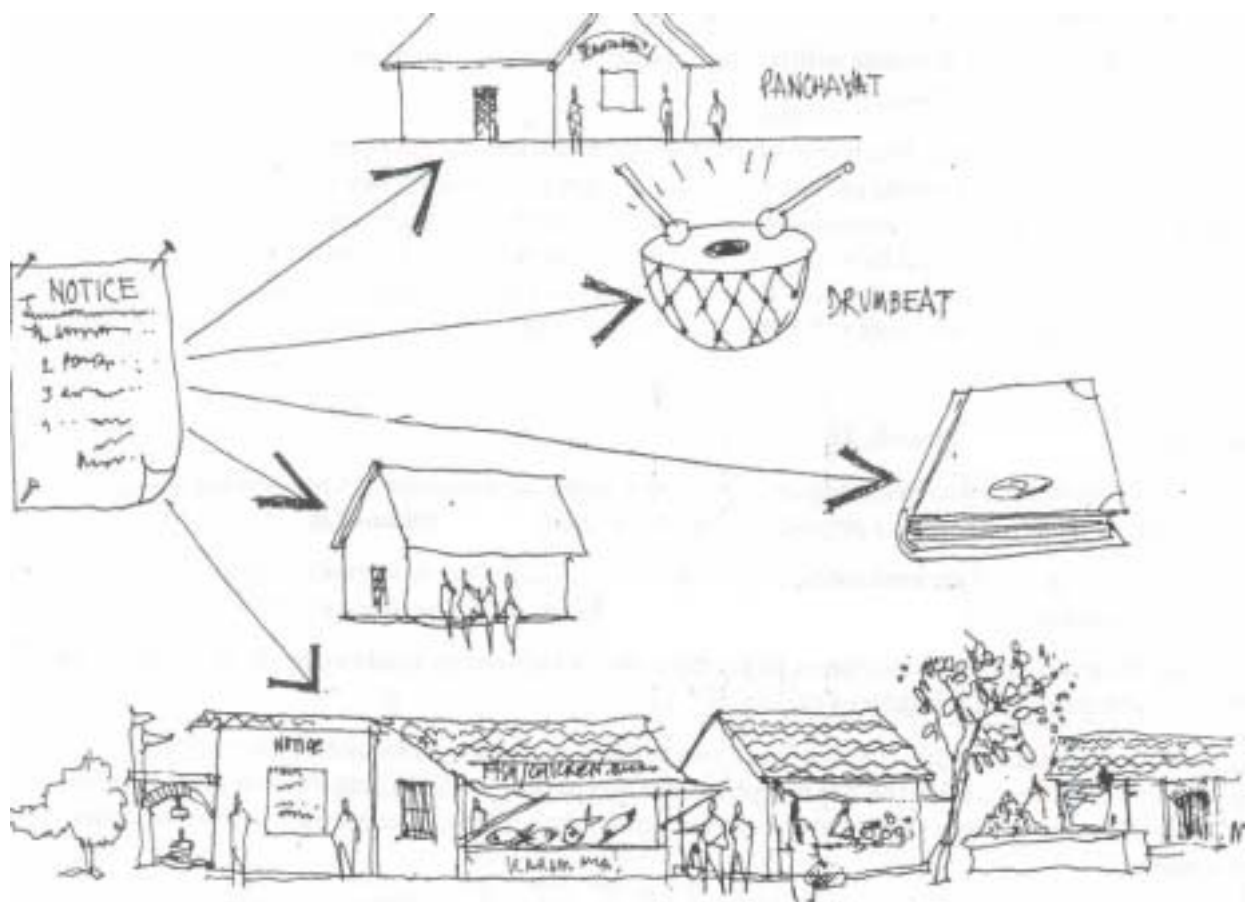

Responsible Agency/Person: PIU (AE/JE), Gram Panchayat (Sarpanch and other members), Community Development Officer



**Format 5      Guidance Note for Transect Walk**  
(During finalization of alignment/transect walk)

- ⚡ Sensitising the community about the sub-project and design compulsions
- ⚡ Route Alternatives
- ⚡ Inventorisation of Environmental and Social Features (Trees, Water bodies, Grazing lands etc)
- ⚡ Inventorisation of Utilities (Electric Pole, Handpump, Wells etc.)
- ⚡ Requirement of Land / Availability of sufficient Land
- ⚡ Locations where extra land will be required
- ⚡ Land Ownership / Land Categories
  - Private Land
  - Government Land
  - Encroachments and Squatters
- ⚡ Design Modifications
  - Road Safety
  - Protection of Cultural Properties
  - Slope for vehicles to enter and exit the road
  - Slope for cattle Crossing
  - Induced Development
  - Lay - by
- ⚡ Plantation
- ⚡ Process of Land Transfer
- ⚡ Profile of Project Affected Persons (PAPs)
- ⚡ Assessment of Social Impacts (Land Structures, Cultural Properties etc.)
- ⚡ **Issues and suggestions of the local people**

**Responsible Agency/Person: PIU (AE/JE), Gram Panchayat (Sarpanch and other members), Community Development Officer**

**Format 6      Outputs of Transect Walk** (After finalization of alignment/transect walk)



- ## Identification of Environmental & Social sensitive location
- ## Likely location for additional land requirement
- ## Issues identified
- ## Suggestion from community

**Modifications to minimize land width accretion and incorporating community suggestions through alterations/modifications on alignment**

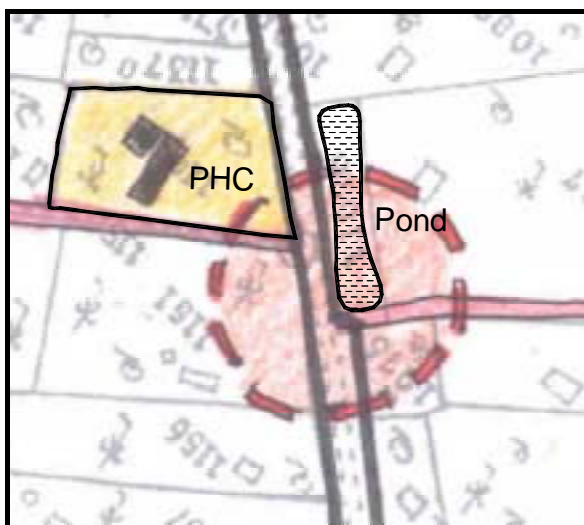

As suggested by the community during the transect walk, the alignment has been modified in view to protect the religious structure on the RHS of the project road. The landowners have provided land voluntarily to avoid dismantling or relocation of the religious structure.

Responsible Agency/Person: PIU (AE/JE), Gram Panchayat (Sarpanch and other members), Community Development Officer, Patwari

**Format 7 Display of Details of PAPs**  
(After identification of PAPs through transect walk)



**District:** \_\_\_\_\_ **Tehsil:** \_\_\_\_\_ **Block:** \_\_\_\_\_

**Name of Project Corridor:** \_\_\_\_\_

**Total Length (km):** \_\_\_\_\_

**Details of PAPs:**

S. No	Village Name	Name of PAP	Vulnerable Category					Type of Impact/Loss				Extent of Loss		Whether Eligible PAP	
			Scheduled Caste	Scheduled Tribe	Below Poverty Line	Women Headed Household	Handicap	Land	Livelihood	Shelter	CPR	Land (m)	Structure (nos)		

**Once land donated, the following restrictions on the land donated**

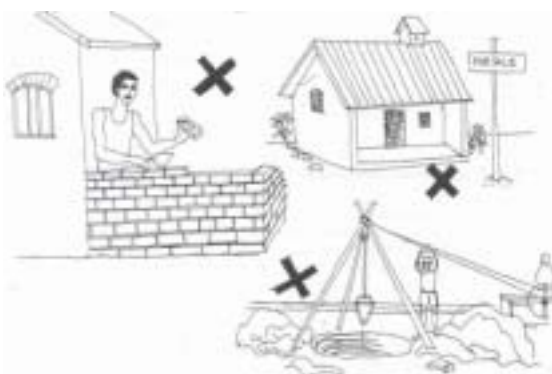

- # Restrictions on construction work
- # Prohibition on sale/ mortgage / lease
- # No Compensation
- # No inheritance by successor



In Case of any Grievances, Contact:

Responsible Agency/Person: PIU (AE/JE), Gram Panchayat (Sarpanch and other members), Community Development Officer



**Format 8 Owners (PAPs/Eligible PAPs) for Voluntary Donation  
(After identification of PAPs & Donation of land)  
(For distribution to Eligible PAPs)**



<b>District:</b>	<b>Tehsil:</b>	<b>Block:</b>
<b>Name of Project Corridor:</b>		<b>Total Length (km):</b>
<b>Roadway Width (m):</b>	<b>Required:</b>	<b>Available:</b>
<b>Carriageway Width (m):</b>	<b>Required:</b>	<b>Available:</b>
<b>Road Land Width (m):</b>	<b>Required:</b>	<b>Available:</b>

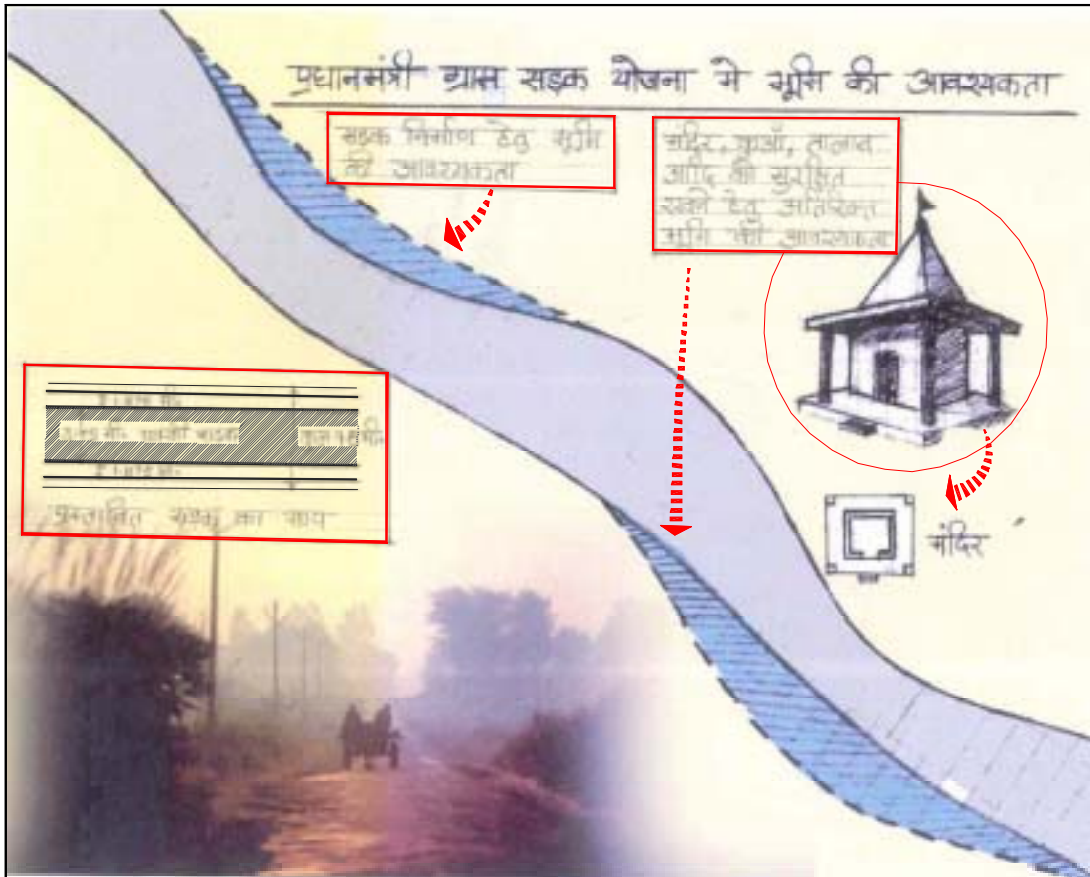

In Case of any Grievances, Contact: Responsible Agency/Person: PIU (AE/JE), Gram Panchayat (Sarpanch and other members), Community Development Officer

**Format 9 Details for Eligible PAPs**  
(After identification of Eligible PAPs through Profile of PAPs)



**District:** \_\_\_\_\_ **Tehsil:** \_\_\_\_\_ **Block:** \_\_\_\_\_

**Name of Sub Project Corridor:** \_\_\_\_\_

**Details of Eligible PAPs:**

Name of Eligible PAP	Type of Loss	Eligible Category	Entitlement

Following categories of PAPs shall be entitled for support as Eligible PAPs:

- ## BPL households (with a valid proof), as per the State poverty line for rural areas;
- ## Other Eligible Categories (i) Women headed households with women as sole earner (ii) Scheduled Caste/Scheduled Tribe and (iii) Handicapped person, and is subject to any of the following impacts;
  - o Loses more than 10%<sup>1</sup> of the total land holding<sup>2</sup>;
  - o Loses shelter; and,
  - o Loses source of livelihood.

Following are suggested measures for addressing various impact categories:

- ## **Land:** Assistance/Support by the community (or) Inclusion of eligible PAPs as beneficiaries in RD programs
- ## **Structures:** Assistance/Support for asset creation by community and Panchayat (or) Inclusion of eligible PAPs losing shelter as beneficiaries in RD programs
- ## **Livelihood:** Inclusion of eligible PAPs as beneficiaries in RD programs
- ## **Common Property Resources:** GP/community with technical inputs from PIU either relocate or construct asset; Consultations with the concerned sections of the community in case of grazing land

The PIU shall be responsible for enrolling the Eligible PAPs under the various Rural Development Schemes as per his/her eligibility. The PIU shall provide the procedure for enrolling in RD scheme and the details of the scheme he/she is being enrolled into. The date and location for the enrollment as well as the disbursement of entitlements shall be disclosed by the PIU in advance to the Eligible PAPs. The name of contact person and address shall also be displayed for any further details required or grievances to be addressed by the Eligible PAPs.



**Details available at (Agency Name, Address, Phone No & Contact Person Name)**

Responsible Agency/Person: PIU (AE/JE), Gram Panchayat (Sarpanch and other members), Community Development Officer

<sup>1</sup> Replace with 20% in case of Himachal Pradesh

<sup>2</sup> The total land holding includes any other land parcels owned elsewhere by the PAP

 <b>PRADHAN MANTRI GRAM SADAK YOJANA</b>		
<b>District:</b>	<b>Tehsil:</b>	<b>Block:</b>
<b>Name of Sub Project Corridor:</b>		
<b>Total Length (km):</b>		
<b>Connected Settlement/s:</b>		
<b>Total Cost (Rs. Lakhs):</b>		
<b>Implementing Agency:</b>		
<b>Name of Contractor:</b>		
<b>Construction Schedule:</b>	<b>Date of Commencement:</b>	<b>Date of Completion:</b>
<b>Scope for involvement of locals as construction labour:</b>	<b>Yes</b>	<b>No</b>
<b>Wages (Rs/Day) as per minimum wages prescribed:</b>		
<b>Grievance Redressal, Contact Person &amp; Frequency of meeting:</b>		
# Village Level		
# District Level		
<b>Contract Details:</b>		
<b>Type of Work:</b>	<b>Road Width (m):</b>	<b>Design Speed (km/hr):</b>
<b>No. of CD Works:</b>	<b>No. of Bridges:</b>	<b>No. of Culverts:</b>
<b>No. of Causeways:</b>	<b>No. of Syphons:</b>	<b>Surface/Side Drains (No X m):</b>
<b>Stages of Construction Work:</b>		
# <b>Earthwork &amp; Gravelling:</b> Clearance of vegetation & rubble, formation & grade soil leveling, soil compaction		
# <b>WBM Work:</b> Laying, Spreading & Compacting stone Aggregate to WBM at Under Layer (mm), Top Layer (mm)		
# <b>Surfacing Work (Bituminous Work):</b> Applying primer coat on granular base, tack coat on surface with bitumen emulsion, laying compacted open graded premix carpet, premix seal coat using hot mix plant& paver		
# <b>CD Works, CC road, drains:</b> Excavation in foundation trances, laying cement concrete, fixing RCC spun/hume pipe, Plaster on new surface in cement & mortar, fixing precast cement concrete, laying pitching on slope		
# <b>Road Furniture:</b> S&F Cut Stone, Sign Board, Warning Reflective Sign Board, PMGSY Information Sign Board with PMGSY Logo		
<b>In case of any concerns in quality of implementation, Contact Executive Engineer, PIU (Agency Name, Address, Phone No &amp; Contact Person Name)</b>		
<b>Contract Document copy available at PIU (Agency Name, Address, Phone No &amp; Contact Person Name)</b>		

Responsible Agency/Person: PIU (AE/JE), Gram Panchayat (Sarpanch and other members), Community Development Officer, Patwari

## ANNEXURE 20-2 METHODOLOGY FOR TRANSECT WALK

*A transect walk is suggested along the proposed alignment with the communities towards finalisation of the alignment. The transect walk shall be a participatory process organised by the PIU in co-ordination with the Gram Panchayat and the revenue officials at the village level. The methodologies for the conduct of transect, the issues to be raised and recording of the same is described in this Annexure.*

### A. WHAT IS A TRANSECT WALK?

**A walk along the suggested alignment by PIU with the communities, PRI and key informants to observe, to listen, and to ask questions which would enable identification of problems and collectively evolve solutions.** The transect shall enable the PIU, to quickly learn about the social structure, issues pertaining to land, social impacts, soils, land use, and community assets and to triangulate data already available. Figures 1 to 4 of this annexure illustrate the recording of the transect on the village revenue maps.

### B. PLANNING AND PREPAREDNESS FOR A TRANSECT WALK

€# The PIU to intimate the PRI at least a week prior to the transect walk. The intimation to the public shall be in the form of a formal notice at the Village Panchayat building.

€# To provide information on the project, provide at least 25 copies of the PMGSY handouts, describing the salient features of the project, including a description of the proposed improvements, land width required and the provisions of the resettlement framework.

€# Collect the village revenue map from the Patwari and mark the suggested alignment. The list of landowners along the suggested alignment to be identified from the revenue records.

€# The PRI to select a group of villagers (key informants) who have good knowledge on physical resources of the village and who are willing to participate in the transect walk.

€# Discuss with the PRI representatives on the basis of the village revenue map the route to follow in the walk. Obtain the suggestions from the PRI representatives on the following questions

€# Where to start?

€# Where to end?

€# What to see?

€# At what time to start?

€# How long will it take?

€# Does the walk need to be split<sup>1</sup> into sections?

€# When does the transect team halt?

€# Provide contacts to the communities regarding the project information. These shall be through (i) Contacting the PIU official, and (ii) Village Pradhan or Sarpanch.

€# Distribute responsibilities for recording information among the members of the PRI, Patwari and the key informants, for activities such as interviewing, time keeping, sketching and recording.

Transect Walk shall halt when...	Identification of key informants...
€#Community or individual has a concern	€# Old people in village community
€#Impact on private land / structures	€# Women representatives
€#Impact on community land	€# School Teacher
€#Impact on Forests & sensitive areas /structures	€# Community representatives
€#Clearances of encroachers	€# Vulnerable Groups
€#Impact on standing crops	
€#Ambiguity pertaining to land ownership	

<sup>1</sup> Long corridor shall require more than one transect.

### C. CONDUCTING A TRANSECT WALK

- ## Based on the responsibilities assigned, the participants shall observe and record in detail all-important things on the revenue map and get as much information as possible from the villagers and the locals. When talking to the villagers, the PIU to feel free to use the **six helpers**:
  - o When?
  - o What?
  - o How?
  - o Where?
  - o Why?
  - o Who?
- ## Make notes of all vital information gathered and draw sketches wherever necessary. The sensitive locations where additional efforts need to be taken during the design will be marked on the revenue map.
- ## Travel slowly and patiently and try to understand the physical features and aspects related to social issues, land titles, in the village from different perspectives.
- ##

Social Aspects ...	Environmental Aspects ...
<ul style="list-style-type: none"> <li>## Sites of additional land uptake</li> <li>## Encroachments and squatters</li> <li>## Land categories impacted</li> <li>## Lands with traditional, customary rights</li> <li>## Population characteristics incl. vulnerable groups</li> <li>## Assessment of social impacts               <ul style="list-style-type: none"> <li>o Land</li> <li>o Structures (Residential/Commercial)</li> <li>o Other structures (Wells, Temples etc)</li> <li>o Trees, standing crops</li> <li>o Common properties</li> <li>o Livelihood and economic opportunities</li> </ul> </li> </ul>	<ul style="list-style-type: none"> <li>## Trees</li> <li>## Forests if any</li> <li>## Drainage lines, rivers and water crossings</li> <li>## Irrigation water courses</li> <li>## Water bodies</li> <li>## Grazing lands</li> <li>## Utilities</li> <li>## Community facilities</li> <li>## Schools</li> <li>## Hospitals</li> <li>## Major junctions and</li> <li>## Seasonal markets or cultural congregations</li> </ul>

- ## The PIU representative to communicate to the participants on site, on the possible extent of improvements. The PIU shall provide adequate responses to the communities on:
  - o Queries raised pertaining to environmental and social issues
  - o Process of voluntary land donation.
  - o Working out possible alignment changes to minimise impacts
  - o Compliance to IRC SP-20 standards to enhance safety of road users.
- ## All queries and concerns of the communities shall be recorded.

### D. THINGS TO DO AFTER THE TRANSECT WALK

- ## After the completion of a transect walk, sit down in a suitable place with the villagers to have a discussion and recording of information and data collected.
- ## Prepare an illustrative diagram of the transect walk on the revenue map using the information already gathered and get the information cross-checked by the community.
- ## Prior to dispersing for the day, finalize a date for the formal consultation session to be conducted.



- €# **Marking centerline** of the proposed alignment on the revenue map
- €# **Assessment of available land width**
- €# **Identification of land categories** and ownership status

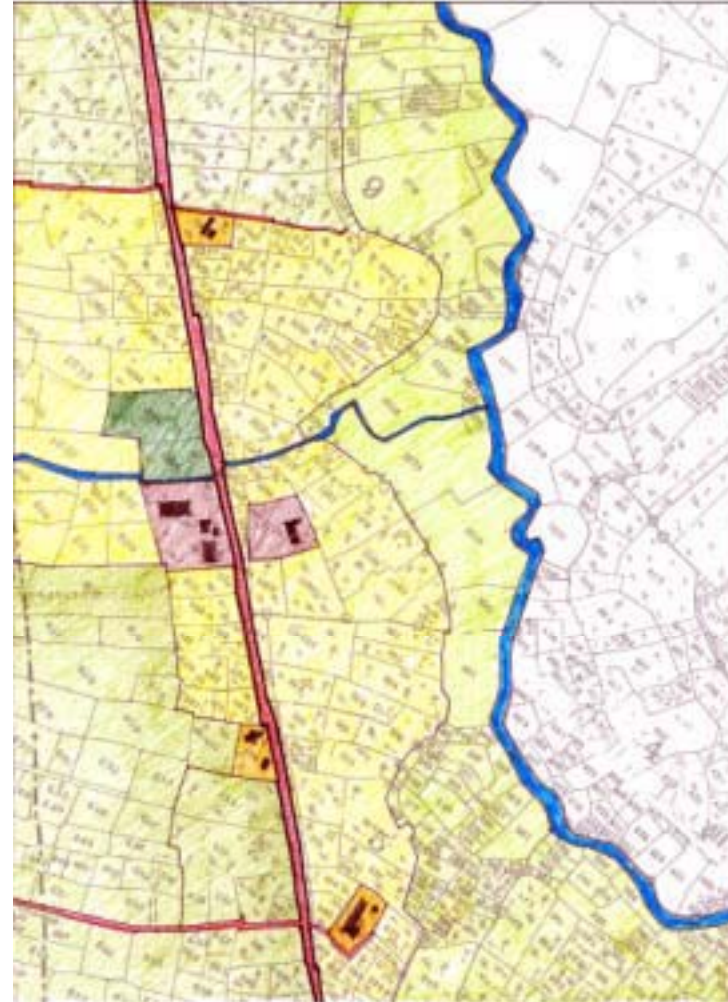

- €# **Inventory of environmental and physical features** along the alignment
- €# **Marking of land uses**

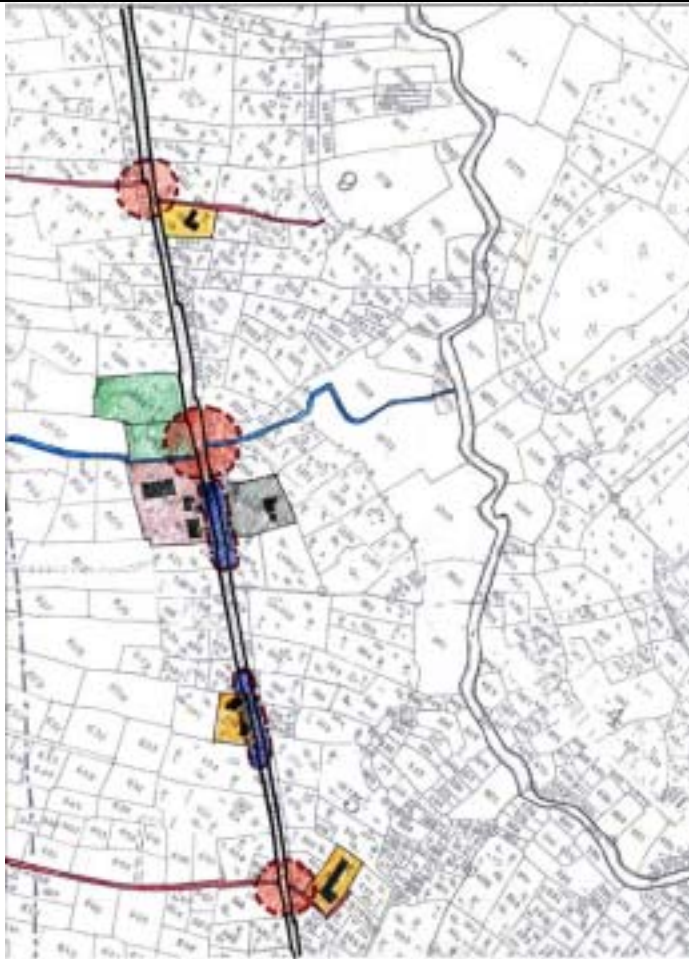

⌘ Identification of sensitive locations as major junctions, cultural properties, water crossings, forests, locations with large number of trees.



⌘ Identification of locations requiring land width accretion  
⌘ Identification of vulnerable persons

**FORMAT FOR RECORDING CONSULTATION**

<b>District</b>	:		<b>Village</b>	:	
<b>Road No</b>	:		<b>Date</b>	:	
<b>Road Name</b>	:		<b>Time</b>	:	
<b>Venue</b>	:		<b>Duration</b>	:	

---

**1. Project Description**

---

**2. Issues raised by the community and responses provided**

**Issues :**

**Response by PIU/PRI:**

---

**3. Key issues**

- (i)
- (ii)
- (iii)

---

**4. Conclusion by PRI representatives**

**Suggested Content of Consultation sessions...**

The meeting duration shall be for about 1-1/2 to 2 hours and shall cover the following.

*All these steps of the consultation shall be recorded in the format*

**I: The session shall start with a description of the project by the PIU officials** to the community. The following information shall be covered:

Overview of PMGSY and criteria for selection

Involvement of PRIs & communities in project planning, design and implementation

Expectations of the project from the beneficiaries, the communities

Outputs of the transect and how the concerns of the communities have been incorporated into the design, if not, why they have not been incorporated

Provisions of the project as the Resettlement Framework provisions, mechanisms for voluntary land donation process etc

Environmental issues in the project, Codes of practice

Survey of Profile of PAPs

Mechanisms for Grievances, implementation arrangements

Involvement of communities / PRI in tree plantation, managing induced development etc

Likely construction schedule

**II : After the description of the project, suggestions from the community on the project and issues will be obtained.**

**III : Responses to the issues raised will be provided by the PIU, PRI during the meeting.** For issues that require a visit to the site or involves certain engineering decisions, or consultations with other Government agencies, a date shall be committed for response to the same. The response shall be given by the PIU to the PRI within the specified date.

**IV : The PIU shall summarize the issues.**

**V: Conclusion by the PRI representatives and attendance of the participants.**

**On a separate sheet mark the attendance at the meeting in the following format**

Community		PIU/PRI	
Name of Person and village of residence	Signature	Name and designation of Official	Signature