

**GOVERNMENT OF INDIA
PRADHAN MANTRI GRAM SADAK YOJANA**

**Environmental and Social Management Framework
for
RURAL ROADS PROJECT II**

ENVIRONMENTAL CODES OF PRACTICE

July 2010

**National Rural Roads Development Agency
Ministry of Rural Development**

Table of Contents

Table of Contents	2
List of Annexures	3
Abbreviations.....	4
ECOP-1.0 PROJECT PLANNING AND DESIGN	
ECOP-2.0 SITE PREPRATION	
ECOP-3.0 CONSTRUCTION CAMPS	
ECOP-4.0 ALTERNATE MATERIALS FOR CONSTRUCTION	
ECOP-5.0 BORROW AREAS	
ECOP.6.0 TOPSOIL SALVAGE, STORAGE AND REPLACEMENT	
ECOP-7.0 QUARRY MANAGEMENT	
ECOP-8.0 WATER FOR CONSTRUCTION	
ECOP-9.0 SLOPE STABILITY AND EROSION CONTROL	
ECOP-9A.0 BIO-ENGINEERING	
ECOP-10.0 WASTE MANAGENENT	
ECOP-11.0 WATER BODIES	
ECOP-12.0 DRAINAGE	
ECOP-13.0 CONSTRUCTION PLANT AND EQUIPMENT MANAGEMENT	
ECOP-14.0 PUBLIC AND WORKER’S HEALTH AND SAFETY	
ECOP-15.0 CULTURAL PROPERTIES	
ECOP-16.0 TREE PLANTATION	
ECOP-17.0 MANAGING INDUCED DEVELOPMEMT	
ECOP-18.0 ENVIRONMENT AUDIT	
ECOP-19.0 NATURAL HABITAT	
ECOP-19 A. BIO-DIVERSITY	
ECOP-20.0 CONSULTATION FOR ENVIRONMENT ASPECTS	

Abbreviations

AAV	Aggregate Abrasion Value
BoQ	Bill of Quantities
CD Structures	Cross Drainage Structures
CPCB	Central Pollution Control Board
DPR	Detailed Project Report
ECoP	Environmental Code of Practice
GP	Gram Panchayat
GS	Gram Sabha
GSB	Granular Sub- Grade
HFL	High Flood Level
IRC	Indian Roads Congress
IS	Indian Standards
MoEF	Ministry of Environment and Forest
MoRD	The Ministry of Rural Development
MoRT&H	Ministry of Road Transport and Highways
MoU	Memorandum of Understanding
NOC	No-Objection Certificate
NREGA	National Rural Employment Act
NQM	National Quality Monitor
O & M	Operation and Maintenance
ODR	Other District Roads
OM	Operations Manual
PIU	Programme Implementation Units
PMGSY	Pradhan Mantri Gram Sadak Yojana
POL	Petrol, Oil and Lubricants
PRIs	Panchayat Raj Institutions
PSV	Polished Stone Value
PUC	Pollution under Control
PWD	Public Works Department
RoW	Right of Way
S W Plains	South West Plains
SP	Special Publications
SPCB	State Pollution Control Board
WBM	Water Bound Macadam

ECoP-1.0 Planning and Design

1.1 General

1.1.1 This code of practice details the factors to be considered during project preparation to avoid/address environmental concerns through modifications in project design and incorporation of mitigation measures. Guidelines specified in the IRC: SP-20:2002 and SP-48 for project preparation are to be followed in conjunction with the measures suggested as part of this ECoP.

1.2 Finalization of Alignment

1.2.1 All requirements of Section 1.5 of IRC: SP-20: 2002 in selection of alignment should be met with. In addition, adequate consultations with the communities to identify the concerns and preferences need to be taken up during selection of the alignment. Rural roads, being low volume roads, shall be aligned to follow the natural topography. Finalisation of alignment shall be carried out in accordance with the provisions presented below.

1.2.2.1 Alignment shall conform to the natural topography as far as possible to avoid excessive cut and fill. In case of hill areas the alignment selection should extend to incorporate the provisions of IRC: SP-48:1998, "Hill Road Manual".

1.2.2.2 Special care should be taken to align the roads along the hill side which is stable and where cutting on hill side causes least disturbance.

The geologist shall investigate the disturbance likely to be caused keeping the geology of hill slope in view. He shall also study the affect of earthquake on the slope gradient.

The alignment should be...

- Short
- Easy and safe to construct and maintain
- Economical
- Laid on firm ground
- Aesthetic and
- Having least adverse environmental impacts.

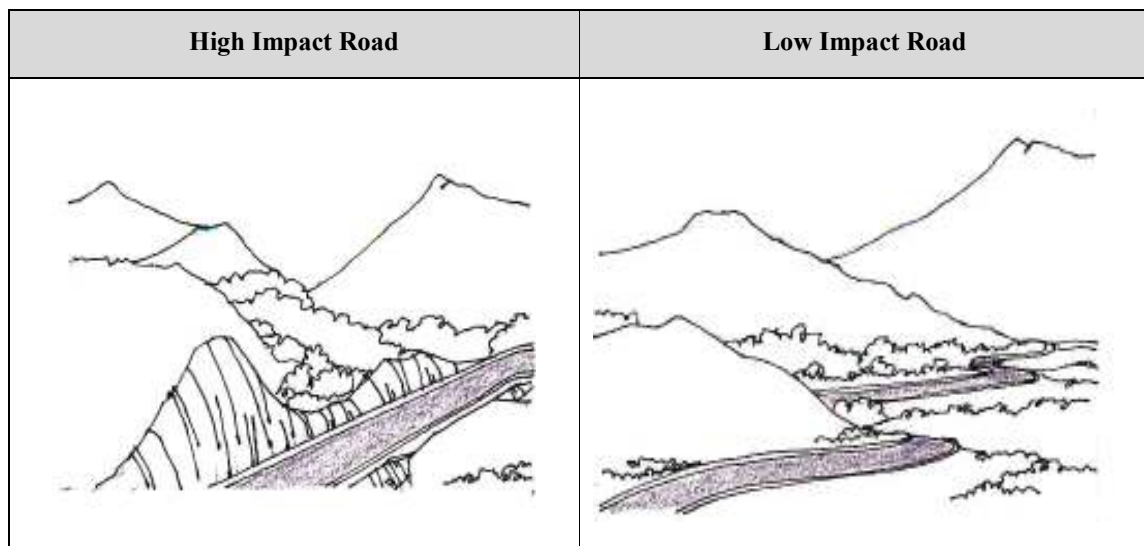

<p>High standard roads</p> <ul style="list-style-type: none"> • Good geometrics • Moves large volume of traffic rapidly and safely. • Huge cuts and fills, stability of slopes • Damage to vegetation, and • Disruption to natural drainage patterns 	<p>Low standard roads</p> <ul style="list-style-type: none"> • Conforms to the natural topography • Suitable for low volume rural roads and low travel speeds • Reduced environmental impacts <ul style="list-style-type: none"> ○ Reduces the cut and fill, ○ Reduces damage to vegetation ○ Minimise changes to natural drainage patterns.
--	--

1.2.2 An inventory of all environmental features along the proposed road is to be prepared and marked on a revenue map. This would be conducted by the PIU in co-ordination with the local community and the revenue officials through transects. Consultations with the local communities are to be conducted during these transects to obtain their suggestions and incorporate their concerns to address the potential environmental impacts. Suggestions of the community during the transect walk are to be incorporated, to the extent possible, while finalising the alignment. The methodology for conduct of transect shall be as per **ECoP-20.0**, “Consultations for Environmental Aspects”.

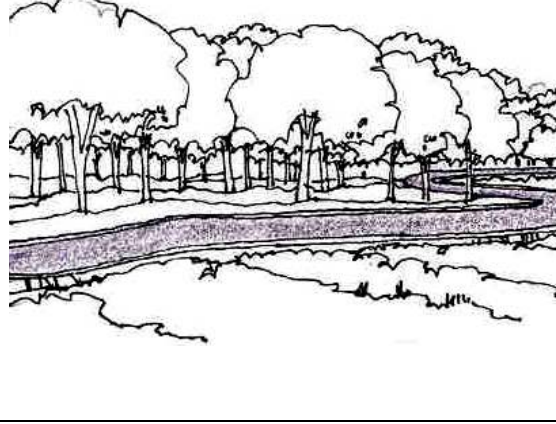
<p>Prepare an Inventory of the following ...</p>	
<ul style="list-style-type: none"> • Trees • Forests if any • Drainage lines, rivers and water crossings • Irrigation water courses • Water bodies • Grazing lands • Cultural properties • Utilities • Community facilities • Schools • Hospitals • Major junctions • Seasonal markets or cultural congregations • Location for Ramps, Cattle Crossing and Bus Bay • Location for stacking maintenance material • Location for ducts for threading agricultural pipes 	
<p>Route Alignment to avoid felling trees</p>	

1.2.3 In case of flood prone areas and/or areas with very flat slopes, hydrological surveys have to be conducted before alignment finalisation. Inputs derived from these surveys such as the need for provision of culverts/bridges or other cross/roadside drainage structures should be considered in the alignment finalisation. Routes involving higher costs on drainage compared to alternative routes should be avoided. In case of hill areas, geological studies have to be conducted to determine locations of loose rock, soil or potential sites for landslides.

1.3 Design considerations

1.3.1 All the road designs should conform to the specifications of IRC:SP-20:2002, “Rural Roads Manual”. Additional measures suggested for minimisation of environmental impacts, safety of road users and for enhancement of community benefits are indicated in this ECoP. Where it is necessary to deviate from the IRC specifications, the following design considerations shall be the absolute minimum.

1.3.2 **Design Speed:** Ruling design speed may be reduced to 40 km/hr from 50 km/hr in plain and 35 km/hr in rolling terrain. This speed is to be followed in link roads less than 10km length without any further relaxation. Ruling speed of 25 km/hr and minimum speed of 10 km/hr shall be followed for all the newly aligned roads in hilly areas. The minimum speed may however be relaxed (on case to case basis) in case of existing alignment where it may not be possible to realign the roads as it may involve excessive cutting or filling.

Recommended Practices for Alignment Finalisation...
<ul style="list-style-type: none"> • Utilise existing revenue tracts as far as possible • Follow natural topography • Conform alignment to within property boundaries within village areas • Adopt geometrics that do not compromise on safety requirements • Avoid crossing power transmission lines, water mains, gas lines etc • Avoid alignments affecting vegetation and felling of trees • Avoid alignments close to streams • Avoid encroachment of water bodies and • Avoid passing through natural habitats as designated forests, sanctuaries, national parks and wetlands

1.3.3 **Road Land Width:** If larger widths are available the existing standards of IRC:SP-20:2002 should be followed. The minimum standard road land width may be reduced to 12 m in plains in areas where it is difficult to obtain 15 m, keeping local conditions in view and after assigning reasons of keeping reduced width. The requirement may be further reduced to 9 m in areas under intensive irrigation and where traffic is less than 100 vehicles/day. But in such cases, the roadway width shall also be reduced to 6 m.. Normally a land width of 12m shall be attempted in case of hill roads. It may be reduced to 9m only in exceptional cases.

Alignment selection criteria in hill roads ...
<ul style="list-style-type: none"> • The road should cross the ridges at their lowest elevation. Relative economics are to be worked out before deciding upon the alignment. • Hairpin bends are to be kept to a minimum. If unavoidable the alignment should be such that a flat hill slope is obtained for its location. • Unstable hill slopes to be avoided, as such slopes are prone to landslides and are subject to seepage or flow from streams. • Avoid encroaching on wetlands or water bodies. • Provide adequate cross-drainage structures to ensure that natural drainage patterns are not altered

1.3.4 **Roadway Width (Formation width):** The minimum of 7.5 m of roadway may be reduced to 6 m incase of hilly terrain¹ and short link village roads connecting single habitations. This would result in reducing the need of larger road land width and reduce quantity of soil required for embankments. A minimum of 9 m of formation / roadway width shall be adopted for cutting section in deserts areas to avoid roadblocks normally caused by dune sand accumulation where reduced width is provided.

Low embankment height reduces...
<ul style="list-style-type: none"> • Quantity of earth work • Redevelopment costs of borrow areas • Dune sand accumulation in desert areas and • Requirement of land for construction of road

¹ In the stretches where obligatory to obtain a road land width of only 6m due to reasons of land availability, minimum roadway width of 5.2m shall be provided.

- 1.3.5 **Carriageway Width:** Standard carriageway width of 3.75 m is to be adopted on all roads. It may be however be reduced to 3.0 m in exceptional cases such as hilly terrain or as per provisions of IRC: SP-20: 2002. Hard shoulders of 1 m width may be provided on either side only in case longer routes or “through” village roads connecting many habitations to cater for the expected increase in traffic intensity
- 1.3.6 **Embankment height:** Lower embankment height of 0.3 – 0.4m to be provided in case of arid and sandy areas. In case of desert areas, the embankment height could be reduced since no overtopping is anticipated. In flood prone areas, height of embankment shall not be reduced and shall be a minimum of 0.6m above expected highest water level. (Based on data of last five years)
- 1.3.7 **Geometrics:** (i) In plain and rolling terrain the alignment should be designed for maximum possible radius of curves. Minimum absolute curve radius of 50m @ 40 km/hr and 38m @ 35 km/hr should be adopted without further relaxation due to safety reasons. (ii) Junction design of access road with collector road should be in conformity with IRC: SP-20: 2002 for both sight distance and flaring requirements. Generally a minimum radius of 14m shall be provide in case of design of hill roads but in exceptional cases it may be reduced to 12m to reduce excessive cost.
- 1.3.8 **Drainage:** For large catchment areas with low ground slopes, the accumulation of water causes flooding on the up-stream of the road. The increased velocity of water passing through the culverts causes scour on the down-stream and alters natural ground levels and scour of land. Hydrological studies are to be conducted in large catchment areas to limit the afflux and provide adequate waterway for cross-drainage structures.

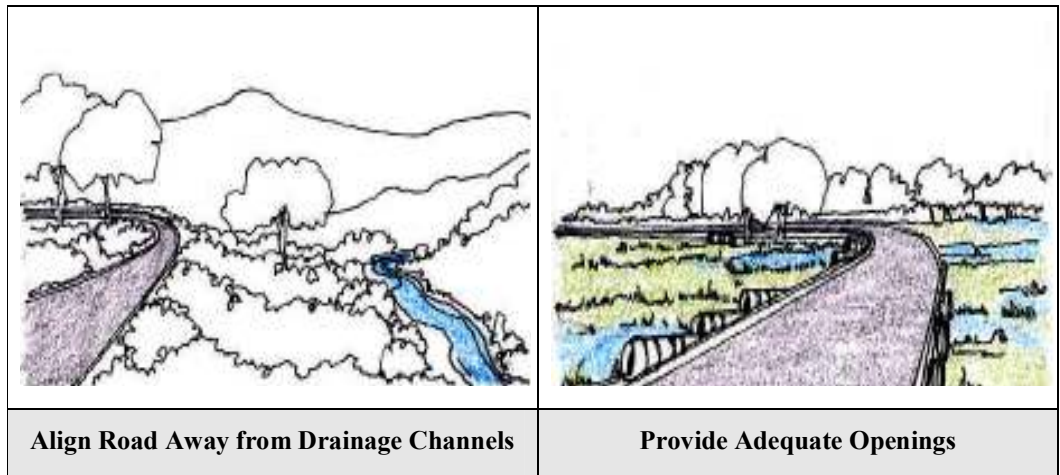

- 1.3.9 **Built up areas:** It should be ensured that the road level in built up areas is lower than the plinth of the adjoining houses and drains are provided to drain the storm water.

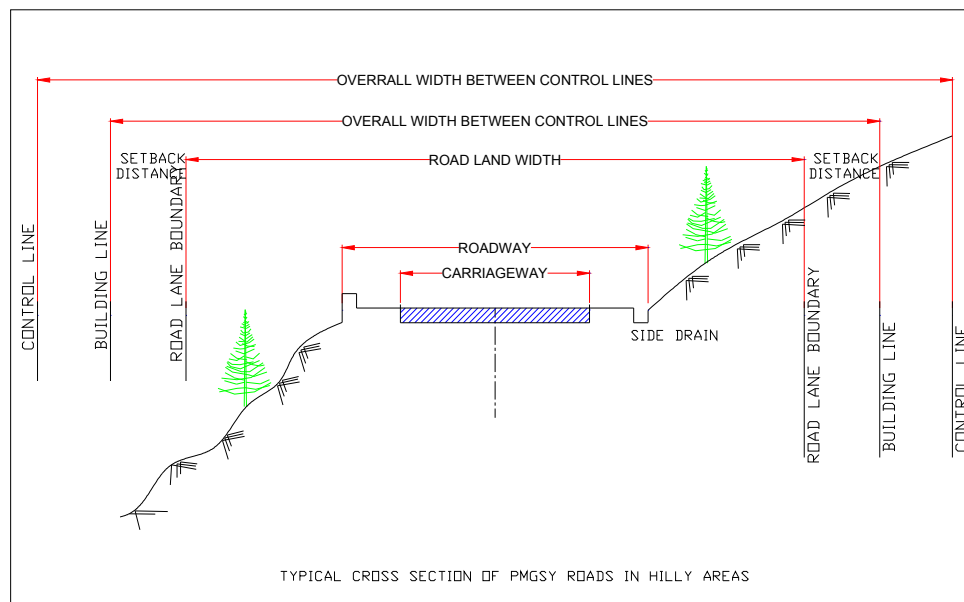
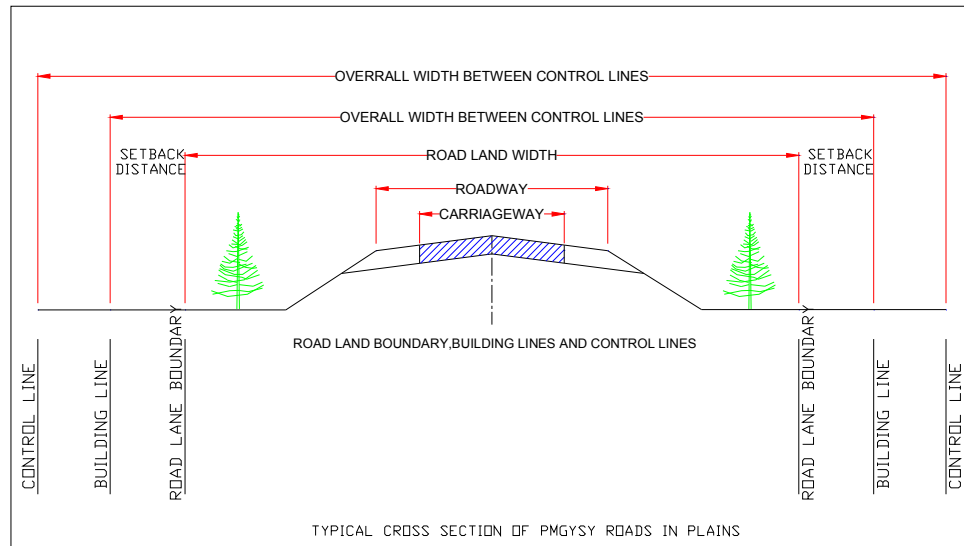

Typical Cross Sections - PMGSY Road

1.3.10 Enhancements

- i. Cattle crossings to be provided at normal crossing routes for safety of both cattle and road user.
- ii. Ramps for access to and from agriculture lands for cross traffic are to be provided to avoid damage to embankment and roadside drain.
- iii. All CD works shall have steps constructed for inspection, repair and maintenance purpose.
- iv. Shoulders should be paved at destination/roadside villages and provide bus bays to avoid traffic obstruction and to provide for turning radius wherever feasible.

- v. Where possible, the embankment should be widened to provide a platform for stacking material for maintenance and to ensure that the shoulders are kept free for movement of traffic.
- vi. Where ever required 300mm ducts should be provided to enable cultivators to thread agricultural pipes for irrigating their fields lying on either side of the proposed road. The invert level of such ducts shall be about 300mm above high flood level.
- vii. On hill roads, passing places are required to facilitate crossing of vehicles. These shall be provided at a rate of at least two per kilometer and exact location to be based on sight condition. The length of passing places shall be about 15-20m with carriageway of 5m.

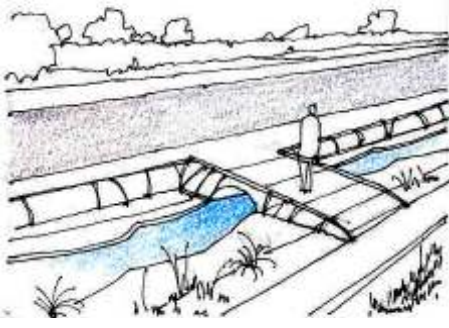
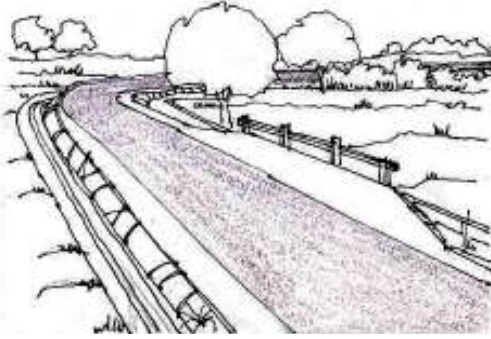
	
<p style="text-align: center;">Ramp for Lateral Traffic/ Cattle crossing</p>	<p style="text-align: center;">Widening of Shoulders for Storing Maintenance Materials</p>

1.3.11 **Community Concerns:** Community concerns, expressed during consultations are to be addressed to the extent possible in the design of the road. The concerns need to be documented (format in annexure). In case any of the measures are not incorporated, the same needs to be intimated to the community with adequate explanation after design finalization.

1.3.12 **Road Signage:** Adequate informatory, cautionary and warning road signs should be provided to ensure traffic safety, especially in the event of adoption of lower standards. The signboards should be placed such that they do not block the line of sight.

Key environmental concerns to be mitigated...

- Land, including loss of productive topsoil
- Drainage
- Land use and livelihood
- Vegetation, cutting of trees
- Forests, wild life, fisheries and aquatic habitat
- Water bodies and water quality
- Slope stability
- Wetlands
- Structures and
- Common property resources
- Disposal of excess material from cut sections

1.4 Environmental Considerations

1.4.1 Environmental considerations for various activities and sub-activities in the project are presented in the Table 1-4. Measures for the same are to be incorporated in the project preparation stage to offset environmental impacts in the subsequent stages (Table 1-3). The measures shall be in conformance with the ECoP referred against the activities.

- 1.4.2 Corridors prioritized as per the core network shall be subjected to screening² as per the screening checklist (Annexure 1-1). The roads so screened as per the checklist shall be subjected to greater analysis in the DPR for the issue/s due to which it is screened.
- 1.4.3 Environmental concerns of the community shall be incorporated to the extent possible in the project preparation and in the subsequent stages of the project. This is achieved through various consultation tools by PIU or Contractor as per the Table 1-1.

Table 1-1: Consultations to be conducted in various stages of the project

Sl.No.	Stage/Activities	Responsible Agencies	Stakeholders	Tools & Techniques	Desired Outputs	Reference
1	Project Prioritization					
1.1	Dissemination of Core network	PIU	Community / PRI	Display of list of villages and length of corridor maps at gram panchayat	<ul style="list-style-type: none"> Increasing awareness of community about PMGSY Transparency in selection of roads 	Resettlement Framework
2	Project Preparation					
2.1	Dissemination of project information	PIU	Community	Distribution of Project Information Brochure	<ul style="list-style-type: none"> Sensitisation of communities Increasing awareness of community about roles and responsibilities 	Resettlement Framework
2.2	Finalisation of Alignment	PIU	Community / PRI	Transect Walk	<ul style="list-style-type: none"> Inventory of environmental features, identification of sites for voluntary donation, identification of PAPs 	ECoP-1
2.3	Formal Consultations with PAPs	PIU	Community	Focus group discussions, public meetings	<ul style="list-style-type: none"> Disseminate information on environmental concerns incorporated/not incorporated into design 	Annexure 20 -2
2.4	Formal Consultation with Flood Control/ Irrigation Department	PIU	PRI/PIU	Focus discussion	<ul style="list-style-type: none"> Information about the Flood Prone areas 	ECoP 1A
3	Implementation Stage					
3.1	Consultations for temporary use of land	Contractor	Community / land owner	Individual consultations	<ul style="list-style-type: none"> Seeking consent on temporary use of land and setting terms of use 	ECoP-3.0 ECoP-5.0 ECoP-6.0 ECoP-10.0 ECoP-13.0 ECoP-14.0
3.2	Consultations for extraction of water	Contractor	Community / Well owner	Individual consultation	<ul style="list-style-type: none"> Seeking consent on extraction of water 	ECoP-8.0
3.3	Consultations for relocation	PIU	Community / PRI	Consultation	<ul style="list-style-type: none"> Area for relocation of utilities and cultural properties 	ECoP-2.0 ECoP-15.0
3.4	Consultation for tree plantation	PIU	Community / PRI	Consultation	<ul style="list-style-type: none"> Identification of persons for tree plantation Location for plantation 	ECoP-16.0
3.5	Consultation for avoiding induced development	PIU	Community / PRI	Consultation	<ul style="list-style-type: none"> Sensitizing PRI on effects of Induced development Identification of locations for avoiding/promoting induced development on community land 	ECoP-17.0

² Screening is not meant to be deterrent for selection of a road. The screening process is intended to facilitate identification of scope for analysis in the DPR stage.

1.4.4 Towards implementation of the environmental provisions by the contractor as per the ECoPs, he shall nominate one of his senior personnel to ensure that the construction practices comply with the ECoPs.

1.5 Compliance to Legal Requirements

1.5.1 The clearance requirements as per the various legislations in force towards the conservation of the environment during the various project stages, as applicable to the project are presented in Table 1-2.

Table 1-2: Environmental Clearance Requirements - PMGSY

Project Stage	Activity requiring clearance	Agency from whom clearance to be sought	Legislative requirement	Responsibility
Pre-construction	Road Projects in Hilly areas & Forests	State Forest office/ state pollution control Board	Environmental Clearance by forest departments for rural roads if the alignment traverses forest areas	PIU
	Diversion of Forest Land	State forest department	Forest Conservation Act 1980	PIU
	Alignment through Sensitive Areas	Forest department,	Transfer of Land Forest (Conservation) Act 1980, Forest (Conservation) Rule 1980	PIU
	Alignment through Flood prone areas	Flood Control/ Irrigation Department	Irrigation Acts of the states eg 'Bihar Irrigation Act 1997' & "The Bihar Irrigation, Flood Management & Drainage Rules 2003'	PIU
	Water for Construction	GWB, Irrigation department/ Village councils	Control on Setting up of Tube Wells	Contractor
	Wild Life Protection	Wild Life Department/ Forest Department	Wild life Protection Acts if alignment passes through Protected Areas	PIU
	Quarry Area Plan	Mining Department	Mining Act of the state	Contractor
Construction	Setting up and O&M of Hot Mix Plants	State Pollution Control Board	Air (Prevention and Control of Pollution) Act 1981 Municipal Solid Waste Management Rules, 2000 & Hazardous Waste Management & Handling Rules, 2000	Contractor
	Noise from construction	State Pollution Control Board	Environment Protection Rules 1986	Contractor
	Blasting operation	Indian Explosives Mining Department	Indian Explosive Rules 1983	Contractor
	Operation of equipment and machinery	Road Transport Office, Pollution Control Board	Motor Vehicles Act, Emission Norms and Standards	Contractor
	Labour laws	Department of Labour	Minimum Wages Act/ Other Labour Laws	Contractor
	Quarry area materials extraction	Mining department	Mining Act	Contractor

1.5.2 The bid document shall include the various applicable clearances pertaining to environmental management and shall contain the necessary procedures for compliance of the same.

1.5.3 The site for construction shall be handed over to the contractor, free from encumbrances and encroachments. Forest clearances, if required shall be obtained prior to start of the project and utilities shall be relocated before handing over the site.

1.6 Integrating Environmental Provisions in Bid Documents

1.6.1 The design and environmental considerations discussed above have to be incorporated suitably in the DPR and the bid document to ensure implementation. Towards this end, the following steps should be taken by the PIU:

1.6.1.1 Detailed Drawings if any for the environmental provisions as per the environmental codes of practice, as required, are to be included in the DPR viz., ECoP-1.0 (Project Planning & Design) Widening of carriageway for bus stops and bus-bays, widening at junctions, ECoP-3.0, Construction Camp, ECoP-11.0, Water bodies and ECoP-15.0, Cultural Properties.. The drawings are to include specifications of the materials used and also the detailed bill of quantities in the bid document.

Construction scheduling – factors to consider...

- Overall scheduling to incorporate climatic factors, snow fall, harsh weather conditions
- Agricultural practices and harvesting seasons
- Timing of specific activities to avoid special weather conditions
- Events of importance in the project area as festive seasons etc
- Availability of local labour during harvest seasons

1.6.1.2 Cost implications of environmental measures suggested by the environmental codes of practice have to be included in the estimates for the project but the state government are expected to make land available free of all encumbrance. Cost of restoration of common property resources, as detailed in social management plan, are expected to be met by the state government

1.6.1.3 Monitoring arrangements towards the implementation of the environmental provisions are to be specified. The reporting formats are provided as per the ECoP-18.0, “Environment Audit”.

1.6.1.4 As per clause 26 of the Standard Bidding Document of MoRD, the contractor is expected to submit for approval of the engineer, the general methods, arrangements, orders and timing for all the activities in the works along with monthly cash flow.

Timing of activities - factors to consider...

- If there is a time lag (more than a fortnight) between WBM and black-topping, the surface needs to be suitably blinded and may have to be rerolled as per the instructions of the Engineer of the PIU.
- The time lag between the prime coat and the final black-topping shall be minimum and in any event be not more than 3 days.
- Sealed coat shall immediately follow the 20mm carpet on the same day.

In scheduling the construction works,

it is expected that the contractor considers all the risks and schedule the activities, which are likely to be impacted by weather phenomenon in a period in which these phenomenon are unlikely to occur. This would also need review and final approval of the engineer. In view of the above approval, the milestones indicated at Para 19 of “Standards Bidding Document-Contract Data to General Conditions of Contract”, to be achieved during the contract period may be suitably amended.

1.6.2 The environmental concerns to be addressed in the preparation of DPR are detailed out in the **Table 1-3** and **Table 1-4**.

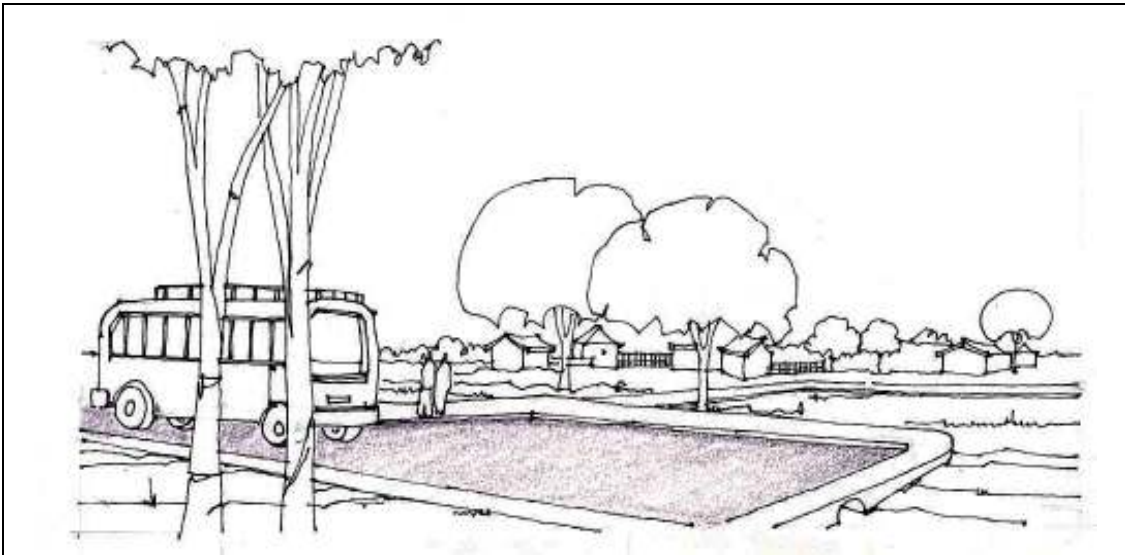

Widening of Carriageway at Destination

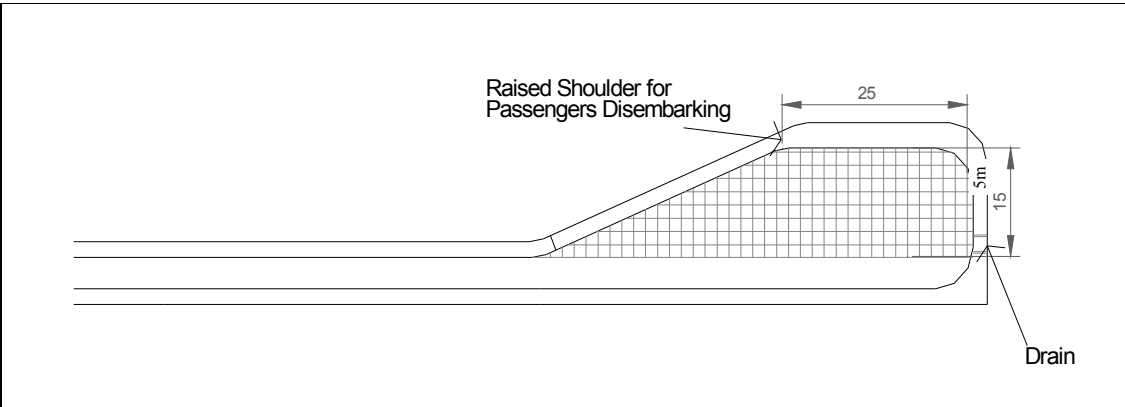

Widening of Carriageway for Turning Radius at the Stops

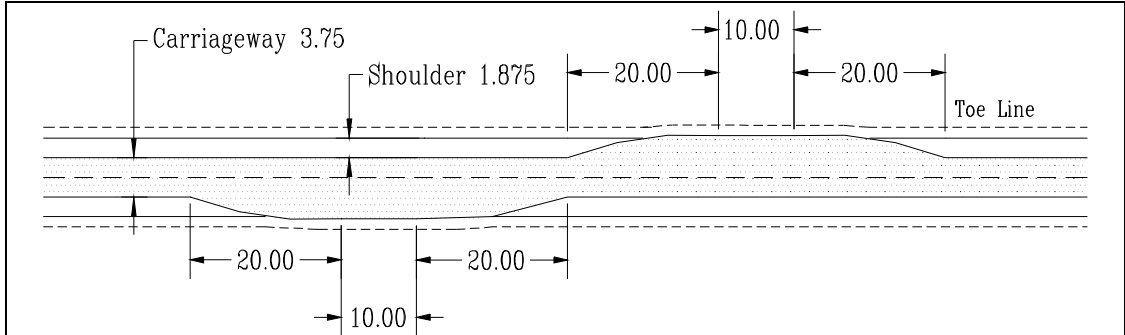

Widening for Bus-Bays on Routes

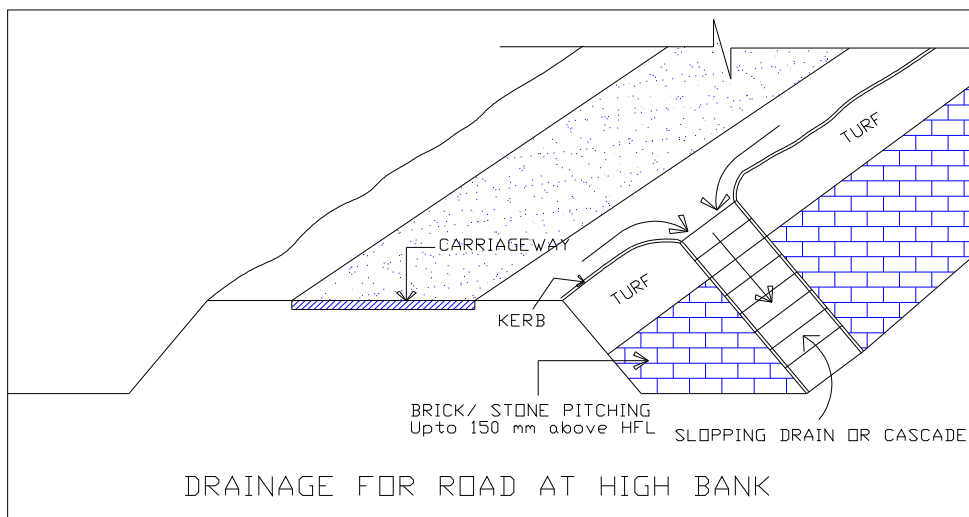
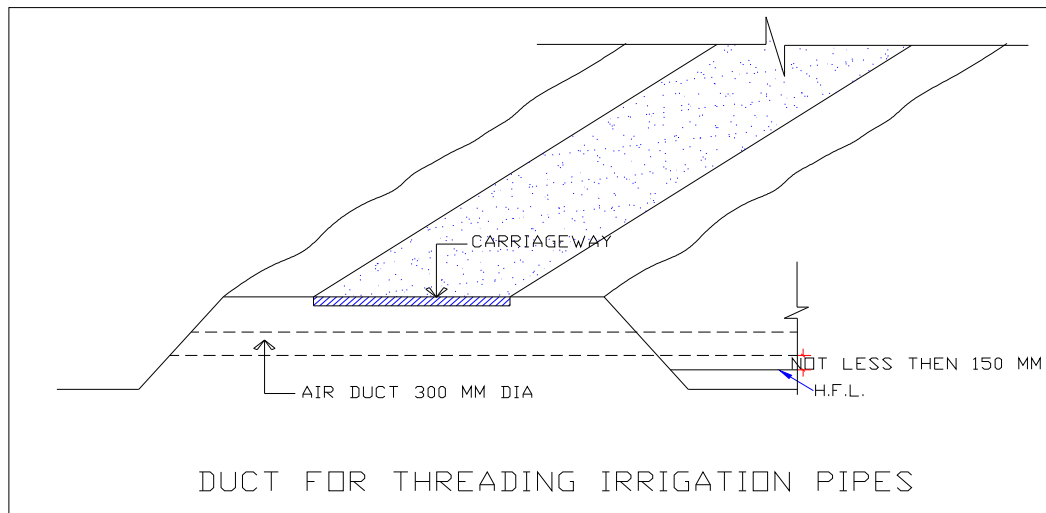
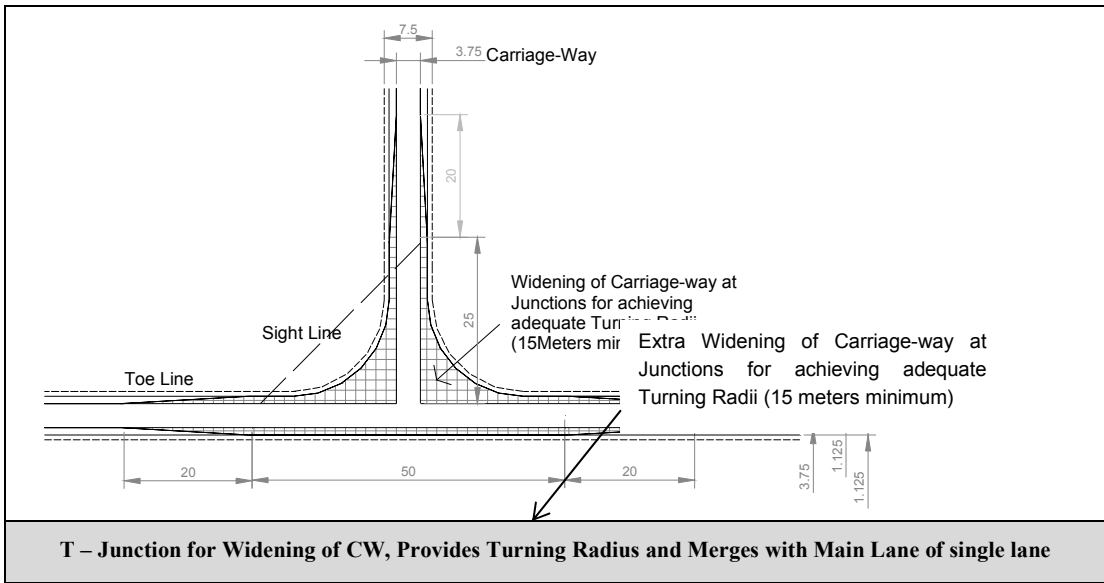

Table 1-3: Environmental concerns in DPR preparation

S.No.	Activity	Items to consider	Measures to address	Detailed in
1.0	Transact Walk	Trees	Inventorisation of environmental features Avoidance, design modifications to minimize adverse environmental impacts Incorporating community concerns into finalizing alignment	ECoP 1.0/ 1.0A
		Forests		
		Drainage lines / Rivers / water crossings		
		Flood prone areas if any		
		Irrigation water courses		
		Water bodies		
		Grazing lands		
		Cultural properties		
		Utilities		
		Community facilities		
		Major junctions		
		Seasonal markets or cultural congregations		
		Location for Ramps, Cattle Crossing and Bus Bay		
		Location for stacking maintenance material		
Location of areas for disposal of debris				
Location for ducts for threading agricultural pipes				
2.0	Detailed Surveys	Geological, geotechnical studies in hill areas	Stability analysis and measures to address slope instability in hill slopes and high banks Working out requirement of cut and fill	ECoP 1.0/1A
		Assessment of angle of hill slopes		
		Topographical surveys		
		Hydrological surveys in flood prone areas	Identification of flood prone areas and measures to avoid high afflux Identification of agricultural use of land	
3.0	Identification of material sources	Borrow material	Utilizing alternative materials	ECoP 4.0
			Minimize requirements through design modifications	ECoP 5.0
			Location criteria	
		Quarry material	Utilizing alternative materials	ECoP 4.0
			Material extraction from existing quarries	ECoP 7.0
		Water availability	Identification of perennial/community/private sources	ECoP 8.0
			Scheduling construction to suit water availability	
			Utilizing community water sources without conflict of uses	
4.0	Assessment of environmental impacts	Climatic factors	Scheduling construction considering the special weather phenomena	ECoP 1.0
		Water bodies	Provision of silt fencing	ECoP 11.0
			Rehabilitation of water bodies	ECoP 20.0
		Stability of slopes	Measures for slope stabilization including bio-engineering practices	ECoP 9.0/ /9.0A
		Soil erosion	Erosion control measures	ECoP 9.0
		Land use changes	Land use control measures adjacent to the road	ECoP 17.0
			Empowering Gram Panchayat / Road Authority to regulate development along road side	
		Agriculture lands	Avoidance from setting up construction camps, borrow areas	ECoP 3.0, ECoP 5.0
Conservation of top soil	ECoP 6.0			

S.No.	Activity	Items to consider	Measures to address	Detailed in
			Site restoration after construction	
		Cultural properties	Avoidance through design modifications	ECoP 15.0
			Planning for Relocation & rehabilitation	
		Common Property Resources	Avoidance through design modification	ECoP 1.0
			Planning for Relocation of consultation with community	
		Drainage	Provision of adequate number of CD Structures	ECoP 12.0
		Trees	Compensatory plantation & arrangements for roadside plantation	ECoP 16.0
Forest areas	Avoidance through design modifications	ECoP 16.0		
	Environment Management measures during construction	ECoP 19.0		
Natural Habitats/ Bio-diversity	Avoidance through design modification or formulating additional measures for avoiding impacts	ECoP 13.0		
5.0	Precautionary measures during construction to avoid environmental impacts	Top soil	Stockpile topsoil and preservation	ECoP 6.0
		Construction sites	Provision of pollution control measures	ECoP 13.0
			All measures to ensure public & worker's health/safety	ECoP 14.0
			Water Management	ECoP 10.0
		Construction camps	Criteria for identification of sites and Infrastructure arrangements	ECoP 3.0
			Safe disposal of all wastes	ECoP 10.0
			Enforcement of pollution control measures	ECoP 13.0
		Borrow areas	Arrangements with land owners to include redevelopment	ECoP 5.0
		Quarry areas	Rehabilitation of quarry areas if new quarries are opened	ECoP 7.0
		Public/workers health & safety	Personal Protective Equipment to be provided	ECoP 14.0
Public safety at construction sites to be undertaken				
Measures for worker's health & hygiene at construction camps	ECoP 3.0			
6.0	Consultations with community	Land for borrowing	Agreement to include borrow area rehabilitation	ECoP 5.0
		Water for construction	Agreements with owners/community for utilizing water	ECoP 8.0
		Site for construction camps	Rehabilitation of the land after construction	ECoP 3.0
		Removal of trees	Tree Plantation as per Roadside Plantation plan	ECoP 16.0
		Cultural properties	Avoidance through modification of alignment	ECoP 15.0
			Relocation costs to be covered in the project, if needs relocation	ECoP 15.0 ECoP 20.0
		Common property resources	Avoidance through modification of alignment	ECoP 2.0
			Relocation, if needed in consultation with community	ECoP 2.0
Traffic during construction	Provision of alternate routes or prior notice to the users	ECoP 14.0		
7.0	Finalization of alignment	Concerns of community	Community concerns to be incorporated	ECoP 1.0
		Environmental impacts identified	Impacts identified are to be mitigated by incorporation of provisions as per ECoPs	All ECoPs
		Design aspects	Impacts that can be mitigated through design modifications should be incorporated	ECoP 1.0
8.0	Preparation of detailed drawings	All concerns/impacts identified	Designs for enhancements and mitigation measures including cost provisions	All ECoPs
9.0	Monitoring of Progress	All environmental aspects identified	Monitoring implementation of Environmental measures	ECoP 18.0

Table 1-4: Environmental Concerns during project implementation (to be identified in DPR)

Sl.No.	Activity and Sub Activity	Impact/s	Measure/s	ECoP Applicable
A Pre-construction Activities				
A1.0	Alignment marking	-Nil-	(i) Co-ordination with Revenue Department	ECoP 1.0 ECoP 2.0
A2.0	Relocation of utilities	Impact on current usage	(i) Identification of relocation site in advance	ECoP 2.0
			(ii) Scheduling the activity in consonance with the community usage pattern	ECoP 2.0
A3.0	Tree Felling	Compliance with Forest Act in case trees are on forest land	(i) Prior clearance from Forest Department	ECoP 1.0
		Loss of canopy	(ii) Tree plantation as per roadside plantation plan	ECoP 16.0
A4.0	Clearance of land	Affect on livelihood	(i) As per project provisions	ECoP 2.0
		Affect on standing crops	(ii) Scheduling of activity and coordination	ECoP 1.0
		Affect on cultural properties	(iii) Modification of alignment or Relocation of the cultural properties	ECoP 15.0
		Affect on natural habitats	(iv) Avoidance of natural habitats or preparation of Natural Habitat Management Plan	ECoP 19.0
A5.0	Diversion of forest land	Compliance with Forest Act	(i) Activity scheduling to avoid delays, conformance to legal requirements	ECoP 1.0
		Affect on flora	(ii) Precautionary measures during construction in forest areas	All ECOPs
		Pollution from construction activities	(iii) Precautions while operating equipment/machinery	ECoP 13.0
A6.0	Transfer of land ownership	Grievances from community	(i) Addressal through Grievance Redressal Mechanisms & Consultations	ECoP 1.0 ECoP 20.0
		Affect on livelihood	(ii) Provision of entitlements as per resettlement framework	ECoP 1.0
A7.0	Location of Storage Yards, labour camps, and construction sites	Pollution from construction camps, storage yards & labour camps	(i) Location criteria to be adopted	ECoP 3.0 ECoP 20.0
			(ii) Obtain clearances from SPCB	ECoP 1.0
		Pressure on local infrastructure	(iii) Infrastructure arrangements to be as per guidelines	ECoP 3.0
A8.0	Procurement of equipments and machinery	Machinery likely to cause pollution at settlements and natural habitats	(i) Machinery to be procured shall be in conformance with noise and emission standards of CPCB	ECoP 13.0 ECoP 19.0
		Safety concerns in machinery operation	(ii) Safety equipment for workers	ECoP 14.0
A9.0	Identification and Selection of Material Sources	Conflict of uses in case of water	(i) Consultations and arrangements at contractor-individual levels, documentation of agreement	ECoP 8.0 ECoP 20.0
		Borrowing causes depressed lands	(ii) Consultations and arrangements at contractor-individual levels, documentation of agreement	ECoP 5.0
		Pollution due to material extraction from borrow and quarry areas to surrounding environment	(iii) Precautionary measures during siting of borrow areas and quarry areas	ECoP 5.0 ECoP 7.0
		Disturbance to Natural Habitats	(iv) Avoidance of location of material sources in Natural Habitats	ECoP 19.0
A10.0	Identification of designated locations of waste disposal	Pollution due to location close to settlements, water bodies & other sensitive areas	(i) Site selection in conformance to criteria provided	ECoP 10.0
A 11.0	Information to community		(i) Keeping local community informed about the construction schedule	ECoP. 2.0
B Construction Activities				
B1.0	Site Clearance			
B1.1	Clearing and Grubbing	Effect on roadside vegetation	(i) Restricting movement of machinery/equipment over adjacent fields	ECoP 2.0 ECoP 13.0
		Debris generation creating unsightly conditions	(ii) Disposal / storage of grubbing waste and possible reuse	ECoP 10.0
B1.2	Dismantling of existing culverts and structures, if any	Generation of Debris creating unsightly conditions	(i) Disposal of waste and likely reuse	ECoP 10.0
		Flooding due to interception to drainage paths	(ii) Provision of diversion channels and/or scheduling construction of culverts preferably in dry months	ECoP 12.0
B2.0	Planning Traffic diversions and Detours	Trampling of vegetation along traffic diversions	(i) Activity scheduling, identification of alternative track	ECoP 14.0
B3.0	Material Procurement	Loss of topsoil	(i) Stripping & Storing topsoil	ECoP 6.0
		Formation of stagnant water pools due to borrowing/quarrying	(ii) Restoration plan for borrow areas & quarry areas (new quarry)	ECoP 5.0 ECoP 7.0
		Illegal quarrying / sand mining	(iii) Conformance of quarries selected to the SPCB requirements, including quarry rehabilitation plans	ECoP 7.0
		Uncontrolled blasting at quarries	(iv) Controlled blasting to the extent required. Conformance to blasting rules as per the Indian Explosives Act	ECoP 7.0

Sl.No.	Activity and Sub Activity	Impact/s	Measure/s	ECoP Applicable
B4.0	Transport of materials to site	Fugitive emissions from transport trucks	(i) Covering of material with tarpaulin or use of covered box trucks during transport	ECoP 10.0
		Dust emissions from haul roads	(ii) Haul road management	ECoP 13.0
B5.0	Materials handling			
B5.1	Storage of materials	Contamination to water sources, leaching into ground water	(i) Provision of impervious base to storage areas	ECoP 3.0
B5.2	Handling of earth	Dust rising and increase in particulate concentration in ambient air	(ii) Use of dust suppressants	ECoP 13.0
B5.3	Handling of fly ash	Increase of particulate concentration and contamination of nearby areas	(iii) Use of dust suppressants	ECoP 4.0
B5.4	Handling of granular material	Risk of injury to workers	(iv) Use of Personal Protective Equipment	ECoP 14.0
B5.5	Handling of bituminous materials	Leaching of materials, contamination of water sources	(v) Provision of impervious base at bitumen storage areas	ECoP 10.0
		Air pollution	(vi) Control of emissions from mixing	ECoP 13.0
B5.6	Handling of oil/diesel	Contamination from accidental spills	(vii) Prevention of accidental spills, affecting cleaning immediately after spill	ECoP 13.0
		Pollution due to incomplete burning	(viii) Ensure complete combustion of fuel through regular maintenance of equipment	ECoP 13.0
B5.7	Waste management	Littering of debris at construction site	(ix) Waste to be disposed at disposal locations only/ utilized in pavement as capping layer/ in sub-base or base course	ECoP 10.0
		Contamination of surroundings due to runoff from construction site	(x) Prevention of runoff from entering water bodies	ECoP 11.0
B5.8	Operation of construction equipments and machinery	Air & Noise pollution	(xi) Conformance to Emission standards and norms	ECoP 13.0
		Operational safety of workers	(xii) Conformance to Safety concerns of the road users and workers in operation, first aid provision and mandatory provision of Personal Protective Equipment	ECoP 14.0
B5.9	Movement of Machinery	Trampling of vegetation	(xiii) Restriction of movement within ROW	ECoP 13.0
		Damage to flora & natural habitats	(xiv) Minimizing impact on vegetation	ECoP 13.0 ECoP 19.0
		Damage to road side properties	(xv) Minimizing impacts on private and common properties, including religious structures	ECoP 13.0 ECoP 15.0
B6.0	Earthworks			
B6.1	Cutting	Uncontrolled blasting in case of rock cutting	(i) Controlled blasting to be made mandatory	ECoP 7.0
		Loss of topsoil	(ii) Preservation of topsoil for reuse	ECoP 6.0
		Waste generation	(iii) Safe disposal of waste & possible reuse	ECoP 10.0
B6.2	Embankment construction	Interruption to drainage	(i) Drainage channels to be provided with culverts in advance to embankment construction as far as possible	ECoP 12.0
		Dust Rising	(ii) Dust suppression with water	ECoP 13.0
		Excess water/material usage	(iii) Minimising height of embankment	ECoP 1.0
			(iv) Scheduling embankment construction preferably in wet months, if possible	ECoP 1.0
			(v) Compaction with vibratory rollers is suggested	ECoP 1.0
		Erosion causing impact on embankment/slope stability	(v) Slope stabilization measures as seeding, mulching & bio-engineering techniques	ECoP 9.0
		Formation of rills / gullies	(vi) Construction of temporary erosion control structures as per requirements	ECoP 9.0
		Contamination of water bodies/ water courses	(vii) Control measures as silt fencing, vegetative barriers etc (viii) Avoiding disposal of liquid wastes into natural water courses	ECoP 9.0 ECoP 11.0
B6.3	Maintenance at construction camp	Collection of rainwater in construction camps	(ix) Temporary drains during construction	ECoP 3.0
		Waste water from labour camps	(x) Disposal of waste water into soak pits	ECoP 3.0
		Contamination of soil	(xi) Removal of oil / other chemical spills & wastes	ECoP 3.0
B6.4	Cutting embankments of surface water bodies	Impact on the drainage flows in and out of the water body	(xii) Restoration of drainage channels	ECoP 11.0
		Embankment stability	(xiii) Design of slopes of the water bodies, slope protection etc	ECoP 9.0
B7.0	Sub-Base & Base courses			
B7.1	Granular sub-base	Extensive extraction of quarry materials	(i) Use of locally available materials (licensed quarry) Use of cut material	ECoP 4.0/ ECoP 10.0
B7.2	Wet mix macadam	Extensive water requirement	(ii) Scheduling the activity preferably in wet months	ECoP 1.0
			(iii) Avoiding conflict of uses due to water extraction from construction	ECoP 8.0
B7.3	Shoulders treatment	Movement of Machinery for compaction	(iv) Restricting movement on adjacent lands	ECoP 13.0
	Slope Protection	Slope stability	Bio-engineering practices	ECoP 9.0A

Sl.No.	Activity and Sub Activity	Impact/s	Measure/s	ECOP Applicable
B8.0	Culverts and Minor Bridge Works	Interruption to water flow	(i) Provision of diversion channels	ECOP 12.0
		Pollution of water channels during construction	(ii) Control of sediment runoff	ECOP 12.0
		Safety of Workers	(iii) Mandatory use of Personal Protective Equipment	ECOP 14.0
B9.0	Surfacing			
B9.1	Bituminous surface	Worker's safety during handling of hot mix	(i) Mandatory use of Personal Protective Equipment	ECOP 14.0
		Damage to vegetation (burning/ cutting)	(ii) Avoiding use of wood as fuel for heating bitumen as far as possible	ECOP 13.0
			(iii) Hot mix plant location to be preferably on waste lands	ECOP 13.0
		Contamination due to bituminous wastes	(iv) Reuse or Land filling of bituminous wastes or use in sub-base	ECOP 10.0
		Impacts on Air quality	(v) Ensuring compliance of hotmix plants with the CPCB emission standards	ECOP 13.0
B9.2	Concrete surfacing for roads crossing built up areas	Contamination of surroundings due to concrete mixing	(vi) Mixing concrete at designated locations away from habitation and agriculture lands	ECOP 3.0
B10.0	Road furniture/Signage	-Nil-	(i) To be provided as per design	
B11.0	Shoulder protection	Requires material extraction from quarries	(i) Use locally available material (licensed quarry)	ECOP 4.0
			(ii) Ensure that all shoulders are clear of debris or construction materials	ECOP 13.0
B12.0	Enhancements	-Nil-	(i) To be included in DPR	ECOP 1.0 ECOP 20.0
B13.0	Monitoring environmental conditions	-Nil-	(i) To be as per the codes of environmental practice	ECOP 18.0
C Post Construction Activities				
C1.0	Clearing of construction camps			
C1.1	Campsite restoration	Change of land use due to setting up of construction camp	(i) Campsite to be restored to its original condition as per the rehabilitation plan	ECOP 3.0
			(ii) Restoration of top soil	ECOP 6.0
C1.2	Dismantling of campsite	Waste generation at the construction site	(iii) Disposal of waste at designated locations	ECOP 10.0
C2.0	Clearing of Water Channels, side drains and culverts	Generation of debris & silt	(i) Removal of Debris and disposal	ECOP 11.0 ECOP 12.0
C3.0	Rehabilitation of borrow areas	-Nil-	(i) Top soil restoration, re-vegetation	ECOP 5.0
C4.0	Clearing of encroachments	Loss of livelihood	(i) Precautionary measures to avoid encroachments	ECOP 17.0
C 5.0	Maintenance of vegetation	Loss of green cover	To ensure that there is no gap of time after handing over and proper maintenance of plants and other vegetation	ECOP 16.0/ ECOP 9.0A

ECoP-2.0 Site Preparation

2.1 General

2.1.1 The preparation of site for construction involves: (i) Marking and clearance of the required RoW of all encroachments by the PIU prior to mobilization of Contractor; (ii) Informing the local community about construction schedule and (iii) Site preparation by the contractor prior to commencement of construction. Scope of this ECoP includes only the measures to address environmental concerns expected during the site preparation. The land acquisition and resettlement issues involved are to be addressed by PIU as per the provisions of the Resettlement and Participatory Framework for the project.

2.2 Site Preparation Activities by the PIU

2.2.1 After obtaining the consent of the community/ Gram Sabha on the alignment, the PIU shall be responsible to stake out the alignment. It shall be the responsibility of the PIU to take over the possession of the proposed RoW and hand over the land width required clear of all encumbrances to the Contractor who shall establish bench marks on ground.

2.2.2 Activities pertaining to the clearance of land and relocation of utilities need to be initiated by the PIU well in advance to by contact with water supply, irrigation electricity and other concerned departments to avoid any delays in handing over of site to the Contractor. Assistance of the Revenue Department shall be sought in accomplishing the task. A MoU to this effect could be signed between the PIU and the Revenue Department (sample format provided in Annexure 2-1).

PIU's responsibilities before handing over site...

- Clearance of encroachments within proposed RoW
- Initiation of process for legal transfer of land title
- Alignment modification or relocation of common property resources in consultation with the local community
- Alignment modification or relocation/removal of utilities in consultation with the various government departments and
- Obtain clearances required from government agencies for felling of trees and diversion of forest land parcel.
- Informing the community and local village councils about the likely schedule of construction

2.3 Site Preparation Activities by the Contractor

2.3.1 The contractor shall submit the schedules and methods of operations for various items during the construction operations to the PIU for approval. The Contractor shall commence operations at site only after the approval of the schedules by the PIU. He shall also keep the community/ village council informed about the likely mile-stones of the achievement and causes of delays, if any.

2.3.2 The activities to be undertaken by the contractor during the clearing and grubbing of the site are as follows:

2.3.3 The clearance of site shall involve the removal of all materials such as trees, bushes, shrubs, stumps, roots, grass, weeds, part of topsoil and rubbish. Towards this end, the Contractor shall adopt the following measures: (i) Limiting the surface area of erodable earth material exposed by clearing and grubbing (ii) Conservation of top soil and stock piling as per the provisions of specifications or ECoP-6.0, "Topsoil Salvage, Storage and Replacement" and (iii) Carry out necessary backfilling of pits resulting from uprooting of trees and stumps with excavated or approved materials to the required compaction conforming to the surrounding area.

- 2.3.4 To minimize the adverse impact on flora and vegetation, only ground cover/shrubs that impinge directly on the permanent works shall be removed. Cutting of trees and vegetation outside the working area shall be avoided under all circumstances. In case the alignment passes through forest areas, Forest Ranger shall be consulted for identification of presence of any rare/endangered species with in the proposed road way. Protection of such species if found shall be as per the directions of the Forest Department.
- 2.3.5 The locations for disposal of grubbing waste shall be finalized prior to the start of the works on any particular section of the road. The selection of the site shall be approved by the PIU. The criteria for disposal of wastes shall be in accordance with ECoP-10.0, “Waste management”.
- 2.3.6 In locations where erosion or sedimentation is likely to be a problem, clearing and grubbing operations should be so scheduled and performed that grading operations and permanent erosion and sedimentation control features can follow immediately, if the project conditions permit.
- 2.3.7 Dismantling of CD structures and culverts shall be carried out in a manner as not to damage the remaining required portion of structures and other surrounding properties. The disposal of wastes shall be in accordance with the provisions of ECoP-10.0, “Waste management”. The following precautions shall be adopted: (i) The waste generated shall not be disposed off in watercourses, to avoid hindrance to the flow, and (ii) All necessary measures shall be taken while working close to cross drainage channels to prevent earthwork, stonework as well as the method of operation from impeding cross drainage at rivers, streams, water canals and existing irrigation and drainage systems.
- 2.3.8 The designated sites duly approved by Implementing Agency shall be cleared of its existing cover for setting up of the construction sites, camps and related infrastructure facilities, borrow areas and other locations identified for temporary use during construction. The contractor shall comply with all safety requirements in consideration as specified in ECoP-14.0, “Public & Worker’s Health and Safety”. Before initiation of site preparation activities along these lands to be used temporarily during construction, it shall be the responsibility of the Contractor to submit and obtain approval of the site restoration plan from the implementing agency. The letter/contract agreement between the owner(s) of the land parcel for temporary usage shall include site restoration to its original status. The guidelines for the same are furnished in ECoP-13.0, “Construction Plants & Equipment Management”; ECoP-3.0, “Construction Camps”; and ECoP-5.0, “Borrow areas”.
- 2.3.9 Site preparation shall involve formation of the road base wherein it is ready for construction of protective/drainage works, carriageway, shoulders, parapets and other road furniture. In hilly terrain, trace cut are already undertaken by the PIU during surveys for alignment marking and design preparation. Implementing Agency shall transfer the land for civil works to the Contractor. Peg marking of the alignment and setting out for the proposed roadwork shall be carried out by the contractor as per detailed drawings and got checked by the supervising engineers.
- 2.3.10 Use of blasting for rock cutting shall be resorted to only if absolutely necessary. It need also to be ensured that the blasting operation do not cause undue instability of existing slopes or movement of rock mass. The BoQ shall provide for controlled blasting to prevent collapse of side slopes and where fly-off of debris are likely to cause damage to other properties. The community shall be informed in advance. Warning signs shall be displayed about the timing of blasting operation. Adequate care should be taken during storage, transport and use of explosives. The shot-firers must be adequately trained and licensed. Suggestions for supervision and observing safety during blasting are detailed in Annexure 2-2. A note on Safety aspects in

blasting has also been appended as Annexure-300.2 in the MoRD Specifications for Rural Roads (Clause 304: Rock Cutting)

- 2.3.11 All regulatory clearances shall be obtained before actual start of work on any stretch of road, including entry permits/inner line permits for non-residents as is required for some northern-eastern states. The contractors shall seek compliance of the applicable regulation/s prior to mobilization.

ECOP-3.0 Construction Camps

3.1 General

3.1.1 The terms and conditions of this Code of Practice pertain to the siting, development, management and restoration of construction camps to avoid or mitigate impacts on the environment. The area requirement for the construction camp shall depend upon the size of contract, number of labourers employed and the extent of machinery deployed.

3.2 Pre-construction stage

3.2.1 The Contractor shall identify the site for construction camp in consultation with the individual owners in case of private lands and the Gram Panchayat in case of Gram Sabha (GS) lands. The suitable sites shall be selected and finalized in consultation with the PIU. Location of construction camps very close to habitations may social hazards and may have impact on life style of local population.

3.2.2 The contractor will work out arrangements for setting up his facilities during the duration of construction with the land owner/Gram Panchayat. The arrangements will include the restoration of the site after the completion of construction. The arrangements will be verified by the PIU.

Selection of construction camp/site locations	
<p>Avoid the following ...</p> <ul style="list-style-type: none"> • Lands close to habitations (nearer than 500m) • Irrigated agricultural lands • Lands belonging to small farmers • Lands under village forests • Lands within 100m of community water bodies and water sources as rivers • Lands within 100m of watercourses • Low lying lands • Lands supporting dense vegetation • Grazing lands and lands with tenure rights • Lands where there is no willingness of the landowner to permit its use 	<p>Prefer the following ...</p> <ul style="list-style-type: none"> • Waste lands • Lands belonging to owners who look upon the temporary use as a source of income • Community lands or government land not used for beneficial purposes • Private non-irrigated lands where the owner is willing and • Lands with an existing access road

3.2.3 After finalization of the site, the contractor shall submit to the PIU a detailed layout plan for development of the construction camp, indicating the various structures to be constructed including the temporary structures to be put up, drainage and other facilities. The plan will include the redevelopment of sites to pre-construction stage. The campsite should cover an area of about 3000 sq.m for 60 number of workers.

Arrangements with landowners...
<p>Contractor shall submit to PIU the following:</p> <ul style="list-style-type: none"> • Written No-objection certificate of the owner/cultivator • Extent of land required and duration of the agreement • Photograph of the site in original condition • Details of site redevelopment after completion

3.2.4 Accommodation: The contractor shall provide, free of cost in the camp site, temporary accommodation to all the workers employed by him for such a period as the construction work is in progress.

- 3.2.5 Drinking Water: Towards the provision and storage of drinking water at the construction camp, the contractor shall ensure the following provisions:
- The contractor shall provide for a sufficient supply of potable water in the construction camp, in earthen pots. The contractor shall identify suitable community water sources as hand pumps for procuring drinking water, in consultation with the Gram Sabha.
 - Every water supply or storage shall be at a distance of not less than 15m from any wastewater / sewage drain or other source of pollution. Water sources within 15m proximity of toilet, drain or any source of pollution will not be used as a source of drinking water.
- 3.2.6 In every site, adequate and suitable facilities for washing clothes and utensils shall be provided and maintained for the use of contract labor employed therein. Separate and adequate bathing facilities shall be provided for the use of male and female workers. Such facilities shall be conveniently accessible and shall be kept in clean and hygienic conditions.
- 3.2.7 Sanitary arrangements, latrines and urinals shall be provided in every work place on the following scale:
- Where female workers are employed, there shall be at least one latrine for every 25 females or part thereof.
 - Where males are employed, there shall be at least one latrine for every 25 males or part thereof.
 - Every latrine shall be under cover and so partitioned off as to secure privacy, and shall have a proper door and fastenings.
 - Where workers of both sexes are employed, there shall be displayed outside each block of latrine and urinal, a notice in the language understood by the majority of the workers “For Men Only” or “For Women Only” as the case may be.
 - The latrines and urinals shall be adequately lighted and shall be maintained in a clean sanitary condition at all times.
 - Water shall be provided in or near the latrines and urinals by storage in suitable containers.
- 3.2.8 Arrangements for Waste Disposal
- Disposal of sanitary wastes and excreta shall be into septic tanks.
 - Kitchen wastes shall be disposed into soak pits. Wastewater from campsites will be discharged and disposed in a kitchen sump located preferably at least 15 meters from any body of water. Sump capacity should be at least 1.3 times the maximum volume of wastewater discharged per day. The bottom of the pit should be filled with coarse gravel and the sides shored up with board, etc. to prevent erosion and collapse of the pit.
 - Solid wastes generated in the construction site shall be reused if recyclable or disposed off in pre-identified/pre-approved locations.
- 3.2.9 First Aid Facilities
- First Aid Box will be provided at every construction campsite and under the charge of a responsible person who shall always be readily available during working hours of the work place. He shall be adequately trained in administering first aid-treatment. Arrangement shall be prescribed to carry injured person or person suddenly taken ill to the nearest hospital.

3.2.10 Storage Site

- Storage of Petrol/Oil/Lubricants: Brick or sand flooring will be provided at the storage places of Petrol/Oil/Lubricants to avoid soil and water contamination due to spillage.
- Storage of cement: Damp-proof flooring, as per IS codes would be required.
- Storage of blasting materials: Shall be as per the specific provisions of law.

3.2.11 Fire fighting arrangement

- Demarcation of area susceptible to fires with cautionary signage
- Portable fire extinguishers and/or sand baskets shall be provided at easily accessible locations in the event of fire
- Workers shall be trained on the usage of such equipment/s.

3.2.12 Prevention of spread of HIV/AIDS

- The contractor/ PIU shall inform the District Health authorities / State AIDS control organizations about the location of the construction camp and the number of workers likely to reside in such camps. They shall arrange to hold awareness training of the workers. They will provide all assistance to the states AIDS control organization to carry out effective surveillance.

3.3 Construction Stage

3.3.1 Construction camps shall be maintained free from litter and in hygienic condition. It should be kept free from spillage of oil, grease or bitumen. Any spillage should be cleaned immediately to avoid pollution of soil, water stored or adjacent water bodies. Following precautions need to be taken in construction camps:

- Measures to ensure that no leaching of oil and grease into water bodies or underground water takes place
- Wastewater should not be disposed into water bodies
- Regular collection and safe disposal of solid wastes should be undertaken.
- All consumables such as the first aid equipment, cleaning equipment for maintaining hygiene and sanitation should be recouped promptly.

3.3.2 PIU will monitor the cleanliness of construction campsites and ensure that the sites are properly maintained throughout the period of the contract.

3.4 Post Construction Stage

3.4.1 At the completion of construction, all construction camp facilities shall be dismantled and removed from the site. The site shall be restored to a condition in no way inferior to the condition prior to commencement of the works. Various activities to be carried out for site restoration are:

- Oil and fuel contaminated soil shall be removed and transported and buried in pre-approved waste disposal areas.
- Soak pits and septic tanks shall be covered and effectively sealed off.
- The contractor shall execute all works to restore the site and land cleared of all debris and shall hand over to the community/land owner or lesser in clean condition without any encumbrance.

ECoP-4.0 Alternate Materials for Construction

4.1 General

4.1.1 The use of alternate materials for construction focuses on the management and reuse of waste materials locally available in the project area with the added advantage of economizing the project cost incase lead for usual road materials is high. Potential waste materials that can be used in PMGSY include: fly ash, blast furnace slag, marble slurry, quarry overburden, and other industrial wastes. Lime or mechanical stabilization techniques should be utilized in case the materials available around the project area are not suitable for construction in its original condition. The guidelines for the use of waste materials in rural roads construction are laid down in IRC:SP-20:2002.

4.2 Project Preparation Stage

4.2.1.1 During the DPR stage, the sources and suitability of alternate materials should be identified. In case of availability of alternate materials, the DPR shall specify the following: (i) Characteristics and availability of the material (ii) Possibility of use in the project (iii) Methods of testing, specifications, recommended usage and (iv) Mechanism for procuring and transporting to the site. The feasibility of its use shall be based on the lead from the project corridor, suitability of the material and the extent of use.

4.2.1.2 The PIU must ensure that provision shall be made in bid document under special conditions of contract specifying the use of fly ash, if available in the vicinity of the project area as per the central government directive on the said subject.

4.2.1.3 A separate BoQ should be included for alternate materials in case they are available in the proximity of the project area and the PIU proposes to include their use for a particular sub-project.

4.3 Pre-construction Stage

4.3.1 Testing shall be done as per IS specifications, in order to evaluate suitability of the alternate materials. In case test results do not match the specifications; option of blending the material with standard materials to meet the required specifications should be explored. The PIU must ensure that the use of alternate material is as per specifications

4.3.2 The Contractor shall approach the supplier identified based on lead and material suitability and shall sign an agreement specifying the quantity of the material to be procured.

4.4 Construction Stage

4.4.1 Care should be taken that all the loose material (fly ash, quarry overburden) are covered to avoid fugitive emissions and spillage during transportation.

4.4.2 In case of transporting slag as well as marble slurry, free board should be maintained and tailboard should be properly closed and sealed.

4.4.3 While storing the alternate material, Contractor shall undertake all precautionary measures to prevent leaching/spillage of the materials.

4.5 Description of Alternate Materials

- 4.5.1 Blast Furnace Slag: The iron and steel plants produce large quantities of waste known as blast furnace slag. While producing 1 ton of steel, nearly an equivalent amount of slag is generated. Hence, the disposal of this slag is of great concern. The engineering properties of this material reflect high bearing capacity as well as good interlocking between slag and aggregate.
- 4.5.2 Blast furnace slag after testing can be used as pavement material as a base or sub-base, either bound or unbound. IRC:SP-20:2002, Chapter 9, gives a brief description of different types of slag available and test method to check their suitability.
- 4.5.3 Fly Ash: Detailed design specifications for the use of fly ash are given in IRC:SP-20:2002, Chapter 9. General requirements of the material for embankment construction with fly ash is given in IRC:SP-58:2001.
- 4.5.4 With the reference to the IRC:SP-20:2002, Chapter 9, Figure 9.3 “Typical cross-section of the embankment with core of fly ash”, considering the formation width 7.5 m and base / sub base height 0.33 m, only at those places where embankment height is greater than 0.83 m fly ash as an alternate material can be used.
- 4.5.5 Quarry Over-Burden: While procuring the aggregates, sand and sub-base material from the quarries, large amount of overburden is generated that can be utilized as fill material for construction of embankment, bridge approaches as well as during the construction of pipe culverts as a cushion.
- 4.5.6 In case quarry operator is other than the Contractor, it is the sole responsibility of the Contractor to procure the overburden. The Contractor must sign an agreement with the quarry owner specifying the details of type of overburden, quantity and the responsibility to transport the overburden. A copy of the agreement has to be submitted to the PIU.
- 4.5.7 Marble Slurry: It is a waste product of the marble industry can be successfully used in:
- Construction of road pavement layers
 - Construction of embankments
 - Back fill material for retaining walls and
 - In mass concrete work as a replacement of fine aggregate i.e. sand upto 40%
- 4.5.8 Locally available bamboos in form of wattle mats can be used for stabilizing slopes and for erosion control measure.
- 4.5.9 Use of Construction Scrap / Waste:
- ECoP-10.0, “Waste Management” identifies commonly generated construction waste that can be utilized during the construction of PMGSY road. Care shall be taken to segregate waste from the mix before reuse.
 - Soil Stabilisation: In soils as black cotton or clayey soils, stabilization techniques as per IRC:SP-20:2002 shall be adopted.

ECoP-5.0 Borrow Areas

5.1 General

- 5.1.1 Embankment fill material is to be procured from borrow areas designated for the purpose. The properties of the borrow material shall be got tested and recorded on Format 4.1 of IRC:SP-20:2002. Scope of this ECoP extends to measures that need to be incorporated during borrow area identification, material extraction and rehabilitation with regard to environment management.

5.2 Project Planning and Design Stage

Earth requirement can be reduced through...	
Measure	Extent of reduction of earth requirement
Reduction of formation width from 7.5 m to 6.0 m in stretches where traffic volume is low	23 %.
Restriction of embankment height to 0.3-0.5 m in areas receiving annual rainfall less than 400mm or at locations where natural drainage is not obstructed and the finished level of the pavement is 0.6-0.8m above the adjoining ground	24%
Use of flyash as an alternate fill material, within a radius of 100 km of Coal or Lignite based thermal power plant as per MoEF Notification, Part II, Section 3, Sub-section (ii), 2002, S.O. 1164(E)	15 %
Industrial and quarry wastes will be utilized as fill material in embankments where suitable material is available.	Varies dependent upon the nature of material

- 5.2.1 Design measures for reduction in quantity of earth work will have to be undertaken to reduce the quantity of material extracted and consequently decrease the borrow area requirement.
- 5.2.2 Borrow area siting should be in compliance with IRC:10-1961. The DPR shall contain (i) Guidelines for locating site of borrow areas (ii) The arrangements to be worked out with the land owner/community for the site and (iii) Sample designs for redevelopment of borrow areas.

5.3 Pre-construction stage

- 5.3.1 The contractor shall identify the borrow area locations in consultation with the individual owners in case of private lands and the Gram Panchayat in case of Gram Sabha lands, after assessing the suitability of the material. The suitable sites shall be selected and finalised in consultation with the PIU.

Borrowing to be avoided on...	Practices to avoid...
<ul style="list-style-type: none"> • Lands close to toe line, but in no case less than 1.5m • Irrigated agricultural lands • Grazing land • Lands within 0.8km of settlements • Environmentally sensitive areas <ul style="list-style-type: none"> ○ Designated protected areas / forests ○ Unstable side-hills ○ Water-bodies ○ Wetlands ○ Streams and seepage areas ○ Areas supporting rare plant/ animal species 	<ul style="list-style-type: none"> • Borrowing adjoining road embankment 

5.3.2 The Contractor will work out arrangements for borrowing with the land owner/Gram Panchayat. The arrangements will include the redevelopment after completion of borrowing. The arrangements will be verified by the PIU /GS to enable redressal of grievances at a later stage of the project. The Engineer of PIU shall approve the borrow area after inspection of the site to verify the reclamation plan and its suitability with the contractor and landowner. The contractor shall commence borrowing soil only after the approval by the PIU.

Arrangements with landowners...	Redevelopment plan to address...
<ul style="list-style-type: none"> • Contractor shall submit to PIU • Written No-objection certificate of the owner/cultivator • Extent of land required and duration of the agreement • Photograph of the site in original condition • Details of site redevelopment after completion 	<ul style="list-style-type: none"> • Land use objectives and agreed post-borrowing activities • Physical aspects (landform stability, erosion, re-establishment of drainage) • Biological aspects (species richness, plant density,) for areas of native re-vegetation • Water quality and soil standards • Public safety issues

5.4 Construction stage

5.4.1 No borrow area shall be operated without permission of the Engineer. The procurement of borrow material should be in conformity to the guidelines laid down in IRC:10-1961. In addition, the contractor should adopt the following precautionary measures to minimise any adverse impacts on the environment:

- i). The unpaved surfaces used for haulage of borrow materials will be maintained dust free by the contractor through sprinkling of water twice a day during the period of use.
- ii). To avoid any embankment slippage, the borrow areas will not be dug continuously, and the size and shape of borrow pits will be decided by the Engineer.
- iii). Borrow pits situated less than 0.8 km (if unavoidable) from villages and settlements should not be dug for more than 30 cm after removing 15cm of topsoil and should be drained.
- iv). The Contractor shall maintain erosion and drainage control in the vicinity of all borrow pits and make sure that surface drains do not affect the adjacent land or future reclamation. This needs to be rechecked by the engineer of the PIU.
- v). In case the borrow pit is on agricultural land, the depth of borrow pits shall not exceed 45 cm and may be dug out to a depth of not more than 30 cm after stripping the 15 cm top soil

aside. In case of stripping and stockpiling of topsoil, provisions of ECoP-6.0, “Topsoil Salvage, Storage and Replacement” need to be followed.

- vi). To prevent damages to adjacent properties, the Contractor shall ensure that an undisturbed buffer zone exists between the distributed borrow areas and adjacent land. Buffer zone shall be 3 m wide or equal to the depth of excavation whichever is greater.
- vii). In case of riverside, borrow pit should be located not less than 15m from the toe of the bank, distance depending on the magnitude and duration of flood to be withstood.
- viii). In no case shall be borrow pit be within 5 mts. from the Toe line of the proposed embankment.
- ix). The reclamation of borrow area shall begin within one month after earthworks are complete in any stretch that is served from a particular source.

5.5 Post Construction Stage

- 5.5.1 It needs to be ensured that all reclamation has been carried out in accordance with the redevelopment plan. The site shall be inspected by the PIU after implementation of the reclamation plan.
- 5.5.2 Certificate of Completion of Reclamation is to be obtained by the Contractor from the landowner that “the land is restored to his satisfaction”. The final payment shall be made after the verification by PIU.

Checklist of items for inspection by PIU ...
<ul style="list-style-type: none"> • Compliance of post-borrowing activities and land use with the reclamation plan • Vegetation density targeted, density achieved in case of re-vegetation, species planted as per reclamation plan • Drainage measures taken for inflow and outflows in case borrow pit is developed as a detention pond • Decrease of risk to public due to reclamation • Condition of the reclaimed area in comparison with the pre-borrowing conditions

ECoP-6.0 Top-soil Salvage, Storage and Replacement

6.1 General

- 6.1.1 Loss of topsoil is a long term impact along PMGSY roads due to (i) site clearance and widening for road formation (ii) development of borrow areas (iii) temporary construction activities as construction camps, material storage locations, diversion routes etc. Scope of this ECoP includes removal, conservation and replacement of topsoil.

6.2 Project Planning & Design Stage

- 6.2.1 The alignment finalization shall be done to minimize uptake of productive land, as laid down in ECoP-1.0, "Project Planning and Design". Stripping of top soil may however be difficult in case of rocky strata and hill slopes.
- 6.2.2 At the project preparation stage, the following shall be estimated: (i) Extent of loss of top soil due to widening and siting of construction activities (ii) Estimates of borrowing requirements and (iii) area requirement for topsoil conservation. The bid document shall include provisions that necessitate the removal and conservation of topsoil at all locations opened up for construction by the Contractor. An item should be provided in the BoQ to cover this activity.

6.3 Pre-construction Stage

- 6.3.1 The arrangements for temporary usage of land, borrowing of earth and materials by the Contractor with the land owner/Gram Sabha shall include the conservation/preservation of topsoil.

6.4 Construction Stage

- 6.4.1 It shall be the responsibility of the Contractor to strip the topsoil at all locations opened up for construction. The stripped topsoil should be carefully stockpiled at suitable accessible locations approved by the PIU. In case of hilly and desert areas, topsoil with humus wherever encountered while opening up the site for construction shall be stripped and stockpiled. (Refer MoRD - Technical Specification no. 301.5.3 and for measurement for payment 301.12)
- 6.4.2 The stockpiles for storing the topsoil shall be designed such that the slope does not exceed 1:2 (vertical to horizontal), and the height of the pile is restricted to 2m. A minimum distance of 1m is required between stockpiles of different materials.
- 6.4.3 In cases where the topsoil has to be preserved for more than a month, the stockpile is to be stabilized within 7 days. The stabilisation shall be carried out through temporary seeding. It consists of planting rapid-growing annual grasses or small grains, to provide initial, temporary cover for erosion control.

Locate stockpiles in ...

- A secure area away from
 - Grade, Subsoil & Overburden materials;
 - Pit activities; and
 - Day-to-day operations.
- Areas that do not interfere with future pit expansion
- Areas away from drainage paths and uphill of sediment barriers.

Vegetative material for stockpile stabilisation...

- Must consist of grasses, legumes, herbaceous, or woody plants or a mixture thereof
- Selection & use of vegetative cover to take into account soil and site characteristics such as drainage, pH, nutrient availability, and climate to ensure permanent growth

6.4.4 After spreading the topsoil on disturbed areas, it must be ensured that topsoil is seeded, and mulched within 30 days of final grading.

6.4.5 During construction, if erosion occurs from stockpiles due to their location in small drainage paths, the sediment-laden runoff should be prevented from entering nearby watercourses.

6.4.6 The Contractor shall preserve the stockpile material for later use on slopes or shoulders as instructed by the Engineer.

Preserving stockpiles – Precautions

- Stockpiles will not be surcharged or otherwise loaded and multiple handling will be kept to a minimum to ensure that no compaction will occur.
- Divert runoff around stockpiles unavoidably located in drainage paths using a perimeter bank uphill.
- The stockpiles shall be covered with gunny bags or tarpaulin immediately in case they are not stored for periods longer than one month.

6.5 Post Construction Stage

6.5.1 The topsoil shall be re-laid on the area after taking the borrow earth to maintain fertility of the agricultural field, finishing it to the required levels and satisfaction of the farmer.

6.5.2 The area to be covered with vegetation shall be prepared to the required levels and slope as detailed in the DPR. The stockpile material shall be spread evenly to a depth of 5-15cm to the designed slopes and watering the same as required. The growth of the vegetation shall be monitored at frequent intervals.

6.5.3 All temporary arrangements made for stockpile preservation and erosion control are to be removed after reusing the stockpile material.

ECoP-7.0 Quarry Management

7.1 General

7.1.1 This code of practice pertains to the measures to address environmental concerns in quarries. The general practice adopted is to procure materials from existing quarries operating with the requisite permits. Scope of this ECoP extends to management measures in the event of the Contractor starting up new quarry³ for extraction of material for this project only.

7.2 Project Planning and Design Stage

7.2.1 The PIU shall provide in the DPR, a list of licensed quarries operating within the district and adjoining districts. In addition, the DPR shall contain the following: (i) Lead from the various existing quarries and (ii) Adequacy of materials for the project in these quarries.

7.2.2 Only in the event of non-availability of existing quarries, shall the Contractor open a new quarry in accordance with Mines and Minerals (Development & Regulation) Act, 1957. The bid document shall include the exhaust quarry redevelopment as per needs of the landowner / community.

7.2.3 In the hilly areas, hard stone available from cutting can be utilized and debris put to productive use as stated in ECoP-10 “Waste Management”

7.3 Pre-construction Stage

7.3.1 In cases where the contractor plans to use existing quarry for procuring materials, only licensed quarry shall be selected and used.

7.3.2 The Contractor shall establish a new quarry only with the prior consent of the PIU only in cases when: (i) Lead from existing quarries is uneconomical and (ii) Alternative material sources are not available. The Contractor shall prepare a Redevelopment Plan for the quarry site and get it approved by the PIU and other regulating agencies. No redevelopment shall be required if the material available from cutting is utilized in the road construction.

7.3.3 The construction schedule and operations plans to be submitted to the PIU prior to commencement of work shall contain a detailed work plan for procuring materials that includes procurement, transportation and storage of quarry materials.

Operations and Redevelopment Plan (if a new quarry is opened)....

- Photograph of the quarry site prior to commencement.
- The quarry boundaries as well as location of the materials deposits, working equipments, stockpiling, access roads and final shape of the pit.
- Drainage and erosion control measures at site.
- Safety Measures during quarry operation.
- Design for redevelopment of exhausted site.

³ The management of environmental concerns in the existing quarries or the redevelopment of exhausted quarries is outside the purview of the Contractor’s scope. This is due to: (i) SPCBs are the nodal agencies for ensuring the quality of air and water, and (ii) The mandate for the monitoring of redevelopment of exhausted quarries is vested with the Government agency issuing permits. Therefore, the quarry operator is not bound to adhere to any additional environmental requirements laid down by the project for the entire quarry operations, as the project is one of the many users of the quarry.

Option A: Re-vegetating the quarry to merge with surrounding landscape: This is done by conserving and re-applying the topsoil for the vegetative growth.

Option B: Developing exhausted quarries as water bodies: The pit shall be reshaped and developed into pond, for harvesting rainwater. This option shall only be considered where the location of quarry is at the lowest point, i.e. surrounding areas / natural drainage slopes towards it or in cases where local people seek water storage for irrigation or other purposes.

7.4 Construction Stage

7.4.1 Site Development: To minimize the adverse impact during excavation of material following measures are need to be undertaken:

- i) Adequate drainage system shall be provided to prevent the flooding of the excavated area
- ii) At the stockpiling locations, the Contractor shall construct sediment barriers to prevent the erosion of excavated material due to runoff.
- iii) Construction of offices, laboratory, workshop and rest places shall be done in the up-wind of the plant to minimize the adverse impact due to dust and noise.
- iv) The access road to the plant shall be constructed taking into consideration location of units and also slope of the ground to regulate the vehicle movement within the plant.
- v) In case of storage of blasting material, all precautions shall be taken as per The Explosive Rules, 1983.

7.4.2 Quarry Operations

- i) Overburden shall be removed and disposed as per ECoP-10.0, “Waste Management”.
- ii) During excavation, slopes shall be flatter than 20 degrees to prevent their sliding. In cases where quarry strata are good and where chances of sliding are less, this restriction can be over-looked.
- iii) In case of blasting, the procedure and safety measures shall be taken as per The Explosive Rules, 1983
- iv) The Contractor shall ensure that all workers related safety measures shall be done as per **ECoP-14.0**, “Public & Workers Health & Safety”.
- v) The Contractor shall ensure maintenance of crushers regularly as per manufacturer’s recommendation.

7.4.3 Stockpiling of the top-soil, if any shall be done as per ECoP-6.0, “Topsoil Salvage, Storage & Replacement.”

7.4.4 During transportation of the material, measures shall be taken as per ECoP-13.0, “Construction Plants and Equipment Management” to minimize the generation of dust and to prevent/reduce the likelihood of accidents.

7.4.5 The PIU and the Technical Examiner shall review the quarry site for the management measures during quarry operation, including the compliance to pollution norms.

7.5 Post Construction Stage

7.5.1 The Contractor shall restore all haul roads used for transporting the material from the quarry to construction site to their original state.

7.5.2 The rehabilitation of the quarry site shall be completed as per the approved plan in case the Contractor has opened-up a new quarry for the project purpose.

ECoP-8.0 Water for Construction

8.1 General

8.1.1 The terms and conditions of this Code of Practice pertain to obtaining water required for construction. Except bituminous works, water is required during all stages of road construction such as Embankment Sub-Grade; Granular sub-base (GSB) and Water Bound Macadam (WBM).

8.2 Project Planning and Design Stage

8.2.1 The Detailed Project Report shall contain the following information:

- Estimate of water requirement based on construction schedule of various stages of the project
- Identification of potential sources of water for construction
- Arrangements to be worked out by the contractor with individual owners, when water is obtained from private sources (which would then be reflected in the Bidding Documents)
- Permits required, if any for opening up new sources, as per the requirements of the existing statutory provisions, and
- Whether scarcity of water would have any impact on schedule of construction.

In water-scarce regions, provide the following additional information in DPR...
--

- | |
|--|
| <ul style="list-style-type: none">• Exploring possibilities for use of existing perennial sources, through interactions with water user groups as the villagers, relevant Panchayat Raj Institutions (PRIs) and the Government Department, keeping in view that the water extraction does not infringe upon the usufruct rights of the existing water users.• Identification of potable water source for domestic use of workers and for use in cement - based construction such as cement concrete roads, culverts and other cross drainage works. |
|--|

8.2.2 Scheduling Construction in Water Scarce Areas: As part of the project preparation, PIU shall conduct an assessment of water requirement and availability in water scarce regions. As far as possible, schedule for construction in these water scarce areas shall be prepared such that earthwork for embankment is carried out just before monsoon, so that water requirement for subsequent construction works such as granular sub-base and water bound macadam are met in monsoon and post-monsoon season, which would depend upon the amount of rainfall and prevalence of dry spells in between such that the construction work can be carried out without much disruption.

8.3 Pre-construction stage

8.3.1 Prior to commencement of extraction of water for construction, the contractor shall work out arrangements as specified in the DPR.

Arrangements for procuring water by contractor...

- In case of community water sources, the Contractor will carry out consultations and obtain written consent of Gram Panchayat for extraction of water through written arrangements with the PRI towards the same.
- In case of private water sources, the Contractor shall not commence procurement of water from a source unless and until the written consent of all current registered owners of the parcel or parcels on which the source is located has been obtained.
- In case of new tube-wells, the Contractor shall obtain clearances required from the Ground Water Board as required. The siting of such tube-wells shall be at a distance of not less than 20m from any septic tank/soak pit or other source of pollution.
- In case of perennial sources, the Contractor shall adhere to all administrative procedures pertaining to procurement of water from such sources.

8.4 Construction Stage

8.4.1 During construction, the Contractor shall be responsible to monitor the following:

- The arrangements worked out with the PRI/individual land owners for water extraction is adhered to.
- Extraction of water is restricted to construction requirement and for domestic use of construction workers.
- Water requirement for curing of concrete shall be minimized by pooling of water over the concrete or by covering with wet gunny bags.
- The potable water used for drinking purposes of construction workers shall be as per the Indian Standard for Drinking Water IS: 10500, 1991.

8.4.2 Prior to issuing project completion certificate to the contractor, the PIU shall verify that the premises of water extraction points are restored to their original status after construction.

ECoP-9.0 Slope Stability and Erosion Control

9.1 General

- 9.1.1 Stability of slopes is a major concern in hill areas and locations of high embankment. In cases of high embankment, water retention at the embankment base initially causes toe failure and subsequently failure of the whole embankment. Soil erosion is consequent to high runoff on hill slopes. High wind velocities cause erosion of embankments made up of cohesion-less sandy soils. Embankments made up of silty and sandy soils are eroded, in the absence of vegetative cover, when the slopes are steep, say more than 20 degrees.
- 9.1.2 Erosion control is provided to prevent soil damage done by moving water, either by displacement of soil by water in motion or deposit of soil by sedimentation at points of low velocity. Erosion in hilly areas occurs when the natural slopes are affected due to cutting or due to ingress of water in the rock mass and leeching/ weakening of jointing compounds.
- 9.1.3 The scope of this ECoP includes measures to minimize the adverse environmental impacts on slope stability and soil erosion due to the construction of roads. The adverse environmental impact can be: (i) damage to adjacent land, (ii) silting of ponds and lakes disturbing the aquatic habitat (iii) erosion of rich and top fertile top layer of soil (iv) contamination of surface water bodies and (v) reduction in road formation width due to erosion of shoulders/berms.

9.2 Project Planning and Design Stage

- 9.2.1 During the detailed project preparation phase, the following investigations shall be carried out prior to finalization of alignment.
- (a) Topographical
 - (b) Hydrological : Interruption and disruption due to existing drainage system
 - (c) Geo-technical
 - (d) Geological Investigation (particularly, slide prone areas of hill roads) and
 - (e) Aesthetic consideration.
- 9.2.2 The rock profile, other information and geologically critical sections are identified based on surveys carried out by Geological Survey of India. Map of the critical areas shall be used as a base for further investigation.
- 9.2.3 Slope stability analysis for retaining / breast walls of height greater than 5m shall be carried out in hilly areas. The stability analysis shall be as per IRC: SP-48: 1998. Based on these investigations slope stabilisation measures are to be incorporated for finalizing the alignment design.
- 9.2.4 In addition to the slope stability analysis the alignment should be such that (i) Steep as well as heavy cuts are avoided, (ii) Flora and fauna of the area are disturbed to a minimum possible extent and (iii) Natural drainage pattern is not obstructed.
- 9.2.5 For high embankments, geo-technical investigations to determine the density of the available material need to be conducted to check its suitability as fill material.

9.3 Pre-construction stage

9.3.1 Interceptor ditches are constructed in hill areas to protect the road bench and hillside slope from erosion due to heavy rainfall and runoff. Interceptor ditches are very effective in the areas of high intensity rainfall and where the slopes are exposed. These are the structures designed to intercept and carry surface run-off away from erodible areas and slopes, thus reducing the potential surface erosion. **Figure 9.1** shows typical installation of interceptor ditch structure as well as ditch lining types. The PIU must ensure that the layout and siting of ditches is as per guideline on Road Drainage IRC:SP-42:1994.

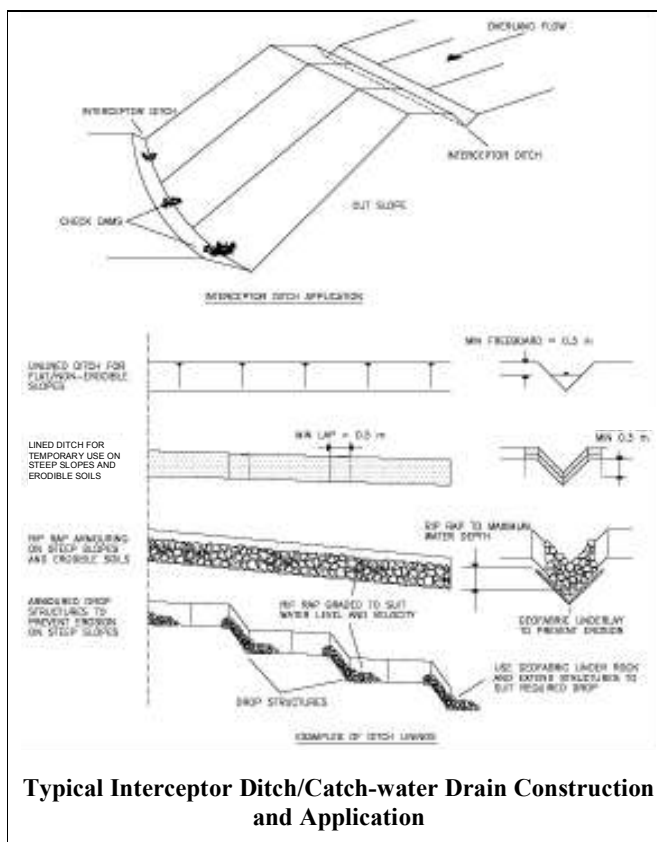

9.4 Construction Stage

- 9.4.1 When alternative material such as fly ash is used for embankment formation, it needs to be ensured that sufficient filter bed is provided along with the top cap. All tests as per IS: 2720 (Parts: 4, 5, 8 & 40) and IRC: SP: 20-2002 are to be conducted on the embankment to keep a check on the compaction achieved.
- 9.4.2 Slope stabilisation techniques and erosion control measures as mentioned below are to be undertaken in hill areas.

Specifications for Vegetative cover
<p><i>Description</i></p> <p>The vegetative cover should be planted in the region where the soil has the capacity to support the plantation and at locations where meteorological conditions favours vegetative growth.</p> <p><i>Site Preparation</i></p> <ul style="list-style-type: none"> To prevent the seeds from being washed away subsequent to sowing, the area should be protected with surface roughening and diversions. Soil samples should be taken from the site and analyzed for fertilizer and lime requirements. <p><i>Seed Application</i></p> <ul style="list-style-type: none"> The seed should be sown uniformly as soon as preparation of the seedbed has been completed. No seed should be sown during windy weather, or when the ground surface is wet, or when not tillable. <p><i>Maintenance</i></p> <p>During first six weeks, the planting should be inspected by the PIU, to check if the growth is uniform and dense. Appropriate moisture levels shall be maintained. There may be requirement of watering the plantings regularly during the dry seasons. Fertilizer and pest control applications may also be needed from time to time.</p>

- Increasing vegetation: On side slopes in hills, immediately after cutting is completed and debris is removed, vegetative growth has to be initiated by planting fast growing species of grass. This would prevent high velocities of runoff and resultant gully formation as well as pounding of water on the road bench. .
- Sausage Walls / Gabions: Sausage wall (commonly termed as Gabions) are being used extensively in hilly areas. The sausage wall are made by forming sausages of galvanized iron or steel wire netting of 4 mm dia having 10 cm square or hexagonal opening and filling the sausages with hard local boulders / stones and wrapping the wire net at the top. The sausage walls can withstand large deformation without cracking and are flexible. Further, due to the open structure, they allow free drainage of water. Sausage Walls shall be shall be constructed in-situ as per IRC: SP: 48-1998.

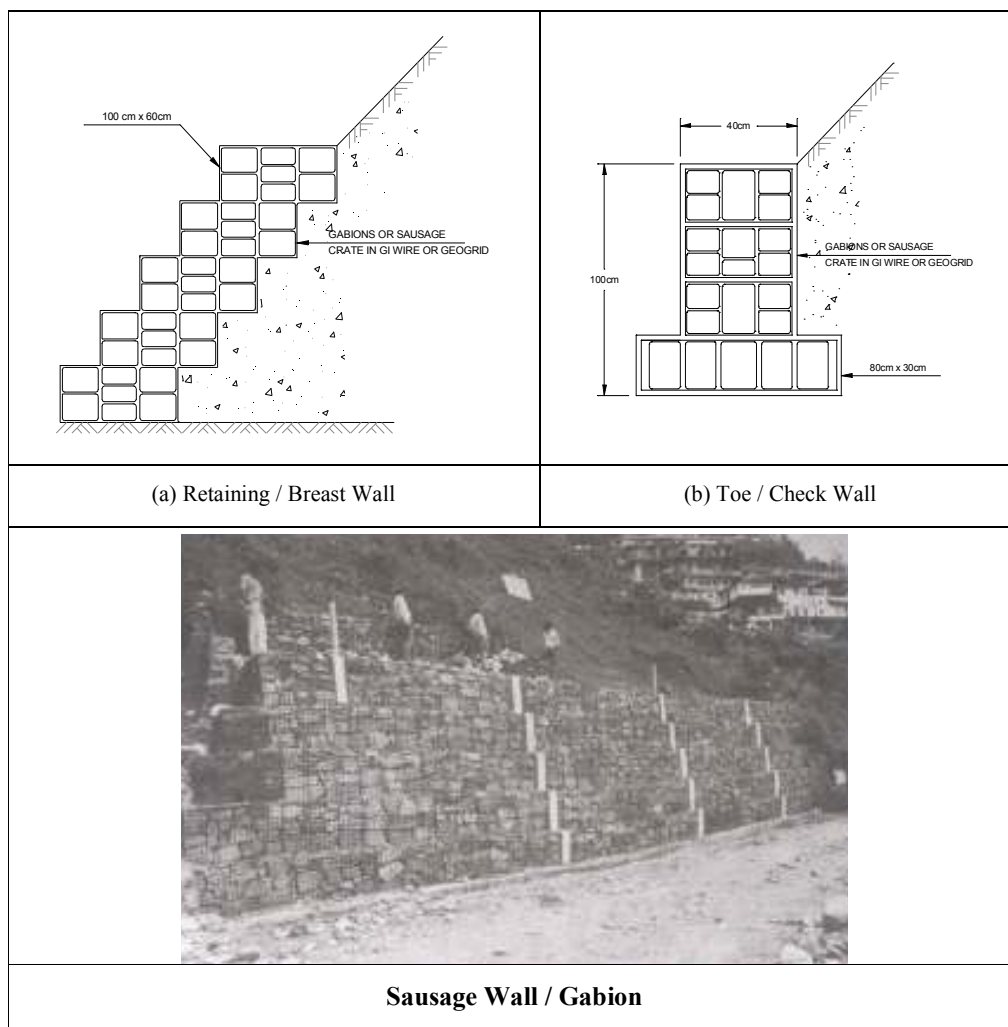

- Bally Benching: To control the erosion on slopes as well as for arresting the shallow movement of top mantle slide mass at the construction location; the Contractor should provide Bally Benching. This method is also very effective in preventing gully erosion. Bally benching shall be installed as per IRC: SP: 48-1998.

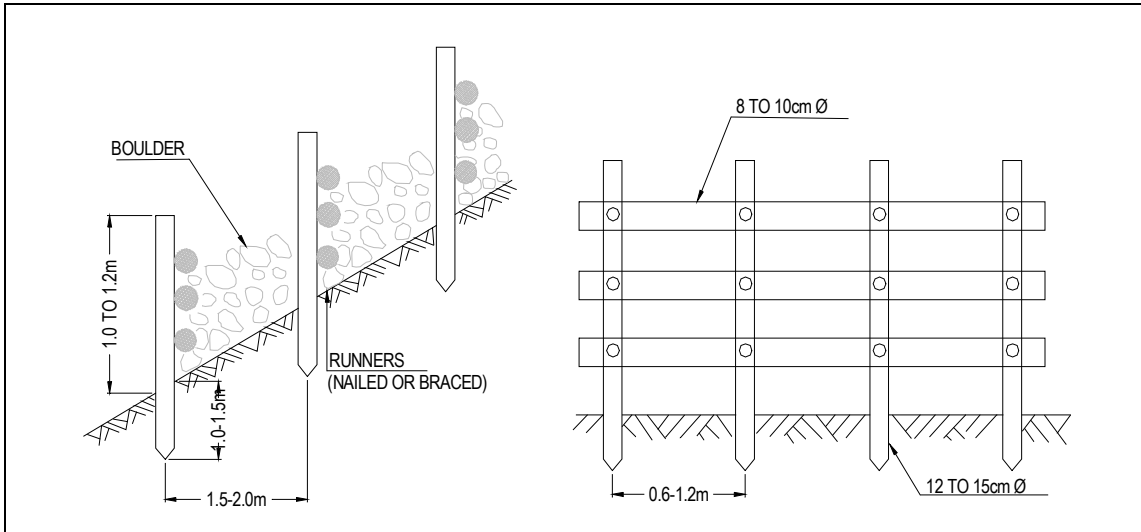

Layout and Design Specification for Bally Benching

- Check dams: Sheet and channel erosion on hill slopes gentler than 1(V):12(H) can be prevented effectively through construction of check dams.

Check Dam

General

A check dam is a small dam constructed in a drainage way to mitigate sheet and channel erosion by restricting the flow velocity. On steeper slopes greater than 1: 12 (H:V), check dams are not effective.

Basic Design Criteria

- Check dams are usually constructed of riprap, logs, sandbags, and/or straw bales.
- The maximum check dam height should be 0.6 m.
- The centre of the check dam should be a minimum of 25 cm lower than the ends to act as a spillway for runoff, as illustrated in Figure 9.3
- Overflow areas should be stabilised to resist erosion.
- Stone check dams should use 7.5 cm or larger stone with side slopes of 2:1 (H:V) or flatter and should be keyed into the sides and bottom of the channel for a minimum depth of 0.6 m. The drainage area for a stone check dam should not exceed 0.2 Sq Km

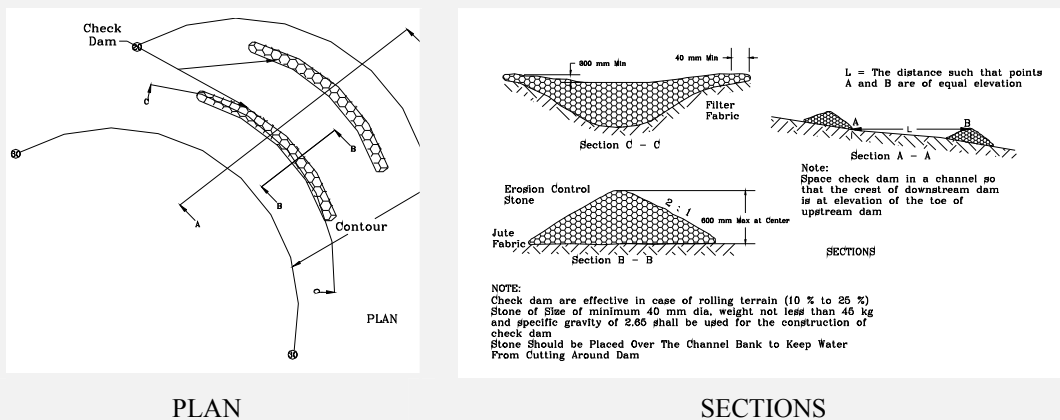

Check Dam Specification

Multiple check dams should be spaced so that the bottom elevation of the upper dam is the same as the top elevation of the next dam downstream, as illustrated above.

Detailed Specifications for Silt Fencing

Description

Silt fencing is a temporary sediment barrier made of woven, synthetic filter fabric supported by steel or wood post. The purpose of the silt fence is to prevent sediment carried by sheet flow from leaving the site and entering to natural drainage or any other water body located near the construction site. Silt fencing encourages the sheet flow and reduces the potential for development of rills and gullies. Care should be taken that silt fences are not installed across streams, ditches, waterways or other concentrated flow areas. All silt fencing should be installed along the contour, never up or down a slope. Where all the sheet flow run off is to be stored behind the silt fence, maximum slope length should not exceed as shown in the table below.

Criteria For Silt Fence Placement

Land Slope (%)	Maximum Slope Length (Above the fence in m)
< 2	30.0
2 to 5	22.5
5 to 10	15.0
10 to 20	7.5
> 20*	4.5

* In areas where slope is greater than 20 %, a flat area length of 3.0 m between the toe of the slope and the fence should be provided

Construction Specification

Silt fencing consists of 1.0 m wide filter fabric and should be placed on the contour. In case runoff flow or velocities are very high or where slope exceed vertical height of 3.0 m, silt fencing should be wire reinforced as shown in the **Figure 9.5**. The contractor should purchase silt fencing in a continuous roll to the length of the barrier to avoid the use of joint. In case of joints, filter cloth should be spliced together only at supporting post, with minimum 15 cm overlap and securely sealed. The pile is to be driven to a depth of 300 mm into the ground by pressing from the top. The frame will be installed at the edge of stockpiles and at the water bodies along which construction is in progress.

Inspection

The PIU will inspect location as well as efficiency of silt fencing. The inspection should be done after every 15 days and in case of storm water, within 24 hours after the end of rain.

Maintenance

The contractor should remove sediments, once they have accumulated to one-half the original height of the fence. Filter fabric should be replaced whenever it has deteriorated to such an extent that the efficacy of the fabric is reduced. Silt fence should remain in place until disturbed areas have been permanently stabilized. All the sediments accumulated should be properly disposed of before the fence is removed. The operation of removing and disposing have to be monitored by the PIU.

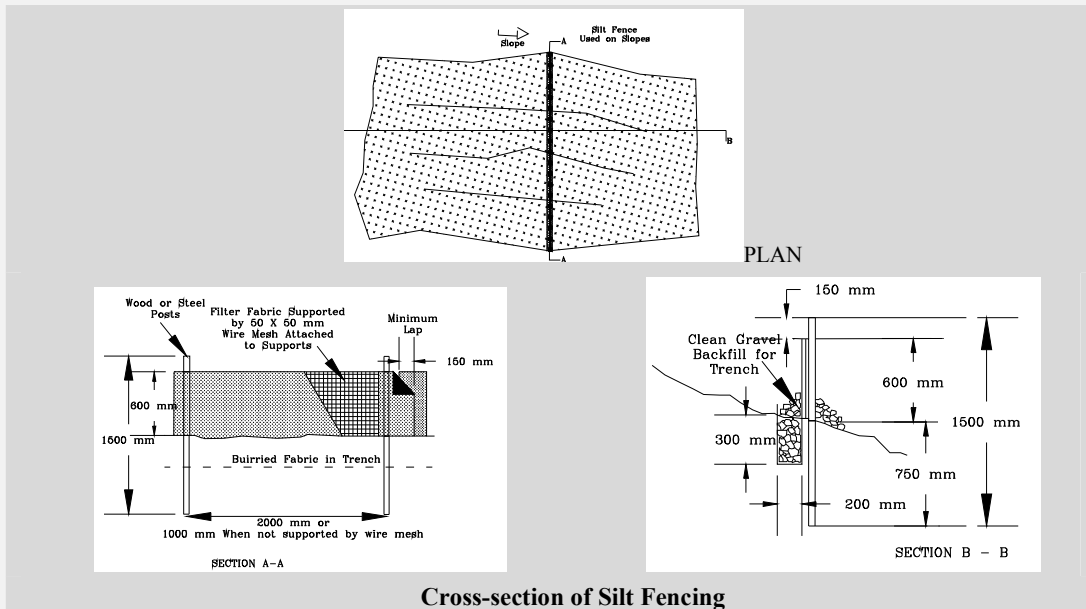

Erosion Control Matting

Description

The design specifications as well as locations should be finalised during the Project Preparation Phase. During the execution period in post-construction stage, PIU must ensure that all the guidelines are to be followed as per specifications during the site preparation and installation of erosion control matting. Following are the steps need to be followed for the placing erosion control matting:

Site Preparation

- The areas should be fertilized and seeded.
- A smooth surface free of depressions that allows water to collect or flow under matting is required.
- The soil should be left with loose surface after seeding.
- The material should be steel wire formed into “U” shape and should be 15 cm to 25 cm long.

Installation

- Filter fabric made of biodegradable material (eg. Jute) should be placed horizontally on the slope less than 2:1
- Prior to netting, a 10 cm anchor trench should be dug at the top and toe of the slope with the top trench placed 30 cm back from the crown, or a berm over which the fabric can be carried.
- For horizontal application, work must proceed from the bottom towards the top of the slope with a 10 cm overlap. Cutting material should be folded less than 7.5 cm to 10 cm at the end, stapled and covered.
- Staples should be placed at a spacing of 22.5 cm to 30 cm apart in the trenches along the horizontal lap joints.

9.4.3 Soil erosion shall be controlled on high embankments by the following techniques:

- Silt Fencing
- In regions of intensive rainfall, locations of steep slopes, regions of high soil erosion potential and regions of short growing seasons, erosion control matting should be provided.
- Brush Barrier

Detailed Specification for Brush Barrier

Description

A brush barrier is a temporary barrier used to control sediment transport by using the residue materials available from clearing and grubbing.

Design and Construction Criteria

- Brush should be cut and windrowed approximately 3 m from the toe of the slope. The brush barrier should be packed densely and should be a minimum of 1.2 m high before compressing. This may be accomplished during clearing and grubbing by having equipment push the brush, tree trimmings, shrubs, stones, root mats, and other materials into a mounded row on the contour. Logs placed within the barrier, parallel to the toe, can help reduce failures.
- A brush barrier may be compressed by running a bulldozer along the top of the windrow. The compressed barrier should be 0.9 m to 1.5 m high and 1.5 m to 3.0 m wide. The top of the barrier should be at least 1.5 m below the finished roadway
- A brush barrier may be left in place after construction unless it is in an aesthetically sensitive area or it is indicated otherwise on plans.

Maintenance

Inspect a brush barrier after each rainfall and make necessary repairs. Sediment deposits should be removed when they reach approximately half the barrier's height.

9.5 Post Construction Stage

- 9.5.1 All the exposed slopes shall preferably be covered with vegetation using grasses, brushes etc. Locally available species possessing the properties of (i) good growth (ii) dense ground cover and (iii) deep root shall be used for stabilization.
- 9.5.2 In case of steep and bare slopes require stabilization, in order to retain the seedling to the ground, asphalt mulch treatment shall be given. Seedling are covered with asphalt emulsion and spread into a thin layer. The asphalt film gradually disintegrates and a carpet of green vegetation and deep-rooted species of grass and clovers, takes its place. (*For details refer IRC: SP 48-1998, Chapter 11*)
- 9.5.3 Anchoring shall be carried out as per IRC: SP: 48-1998, Chapter 11 in case of rocks.
- 9.5.4 Regular inspection of check dams and repositioning/replacement of dislodged or stolen stones need to be carried out.
- 9.5.5 Repair and maintenance of eroded side drain inverts is to be done in order to arrest retrogradation of levels in side drains. Slopes of high embankment can give a fertile base for growth of vegetative cover/sodding.

ECoP-9A : Bio-Engineering

9A.1 General

9A.1.1 Bio-Engineering is the use of living plants for engineering purposes. Vegetation is carefully selected for the functions it can serve in stabilising roadside slopes and for its suitability at site. Soil bioengineering provides attractive cost-effective and environmentally compatible ways to protect slopes against surface erosion and shallow mass movement.

9A.1.2 This code of practice envisages the use of Bio-Engineering techniques to be undertaken for protection of slopes against erosion either alone or in conjunction with civil engineering structures. It can also help in reducing planer movement, can be used to improve drainage and reduce slumping. A holistic approach to bioengineering incorporates the use of individual dormant un-rooted bundles of branches (live fascines), dormant unbundled branches (brush layering), and combinations with live transplanting and seeding.

9A.1.3. Normally Bio-engineering alone is mostly used for relatively small-scale works, such as armouring bare cuts and fill slopes against erosion, catching debris to reduce drain blockages and so on. They are effective at depths of up to 500mm below the depth.

9A.1.4 The Bio-Engineering techniques in conjunction with civil engineering structures can be designed for armouring of slopes against slope failures. Where the better quality engineering solution is being sought, designs that incorporate bio-engineering are usually most effective and the most economic solutions for the shallow-seated problems listed above. Obviously, the use of bio-engineering solutions costs more in the short term than ‘do-nothing’ approach. But in the long term, there should be additional benefits from reduced maintenance costs. Some examples of use of Bio-engineering are given below:

How does bio-engineering work?

Bio-engineering systems work by fulfilling the engineering functions required for the protection and stabilizing of slopes. The difference between re-vegetation and bio-engineering is that that the plant must provide one or more of the roles of catching debris, armouring the surface, reinforcing the soil, anchoring the surface layer, supporting the slope or draining the material. This means serving an engineering function.

Scope/ Examples of use of Bio-Engineering	
<ul style="list-style-type: none"> • Prevention of scour around drains and culvert discharge points • Prevention of scour around civil engineering structures, particularly at the soil/structure interface • Protection against debris blocking the side drains • Protection against debris coming on to the carriageway • Protection of un-compacted spoil • Protection of embankments and fill areas • Protection of bare cut slopes 	<ul style="list-style-type: none"> • Protection of bare surfaces on rehabilitated land slides • Protection of slope toes from erosion, where undercutting and over-steepening may arise • Stabilising of gullies • Rehabilitation of quarries and borrow pits • Prevention of shallow planer failures (less than 0.5 m deep) • Prevention of shallow slumps (less than 0.5 m deep) • Reduction of minor falls in weak, shattered rock • Reduction of debris creep on steep, unconsolidated colluvial slopes.

9A.2. Project Planning and Design

- Bio-engineering works are planned in the same manner as other works. Unstable hill, cut slopes and likely location of unstable/vulnerable sites slides shall be identified on the basis of geological inputs and local information about the occurrence of slips.
- The technique of civil engineering or bio-engineering to be adopted shall be based on the hill slope angle as well as the local geology and optimum technique designed to stabilize such unstable slopes. The slope sites can then be divided into various segments and most appropriate technique chosen.
- The planning shall involve selection of the technique of Bio-engineering appropriate to the bio-physical conditions of the region, integration with standard civil engineering measures, the role of vegetation, plant species selection, propagation and construction techniques.
- Select the right species of plant or shrub for use, in each case, for the site keeping in view technique, propagation and suitability.

9A.3. Pre-construction Stage

- The schedule of implementation of bio-engineering works shall be scheduled precisely in line with the season. It should also take into account the time taken for vegetation to become established and reach full strength.
- It shall be ensured that the site have been prepared for plantation and slopes trimmed to receive the saplings or grasses.
- Calculate the quantities of seeds or numbers of saplings required for the work and identify the source of procurement.
- Work out the requirement of water that may be required for sprinkling on the newly planted saplings.
- Identify the location of waste disposal.

9A.4 Construction Stage

- It shall be ensured that all planting stock is of high quality and is vigorous enough to grow on the site to be planted. The plants and cutting used shall be disease resistant
- Debris generated from the clearance operations shall be deposited only at pre-identified waste disposal locations. .
- Plantation shall be scheduled immediately after the first rain when there is sufficient moisture and the grasses/saplings get established. These may have to be protected for some time from grazing cattle or other such factors. It shall also be ensured that the plants do not get dislodged due to other construction activities. The area may need to be fenced till the plants become established.
- It needs to be checked that the work has been completed to a high standard and the progress of growth monitored. Weeding may be carried out as required.

9A.5. Post Construction Stage

- It also takes time for the vegetation to become established and reach full strength. It is therefore important to ensure that the works have been completed to a high standard at the site and the sites are completely covered without any gap. This must be verified at site before finalization of the contract.
- The maintenance of bio-engineering works is a part of the road side maintenance. Like other elements of maintenance the contractor would be responsible for routine and preventive maintenance activities of all such structures.
- The progress of growth of the plants needs to be monitored by the supervisory staff and re-plantation carried out to replace any dead stock.

ECoP-10.0 Waste Management

10.1 General

10.1.1 This code of practice describes procedures for handling, reuse and disposal of waste materials during construction. The waste materials generated can be classified into (i) Construction Waste and (ii) Domestic waste.

10.2 Project Planning and Design Stage

10.2.1 As part of DPR preparation, PIU shall carry out the following:

- Finalize road design and alignment to minimize waste generation through balancing of cut and fill operations rather than aligning the entire road width in cutting and minimizing excess cuts requiring disposal.
- Identify the type of wastes as well as sources of waste during construction and suggest options for possible reuse. Assess the quantity of cut material that can be used in construction of the parking spaces, passing places and other facilities.
- In case debris generated from cutting in hill areas cannot be reused, these need to be disposed off properly. One possible option involves construction of gabion walls on valley side at ridge locations to form a trough for waste disposal. As the ridge locations usually have streams flowing through, length of pipe provided at the culvert should be extended to let runoff flow out of the disposal location. After filling up of the disposal site, it can be suitably vegetated to prevent erosion of the disposed soil.
- Examine the possibility of utilizing the hard stones and other cut materials for pavement construction, retaining or protection walls, lining of side and chute drains, stabilizing sub-base, head walls, wing walls parapets etc.
- Provide guidelines to the contractor for locating waste disposal sites for non-toxic wastes
- Identify locations, in consultation with the community, to use the waste material for leveling of playgrounds of village schools.
- Utilizing the cut material for laying and compacting a capping layer on full width of formation
- Identify existing landfill sites if available for disposal of toxic materials.
- In case no existing landfill sites are available, identification of landfill site as well as decommissioning of these site should be undertaken. Towards this, identify the clearance requirements.
- Include in the bid document under the Special Conditions of Contract, a clause stating that all provisions of Environmental Codes of Practice shall be applicable to the locations of disposal of wastes. These shall include: **ECoP-6.0**, “Topsoil Salvage, Storage and Replacement”, **ECoP-9.0**, “Slope Stability and Erosion Control” and **ECoP-12.0**, “Drainage”.

10.2.2. Disposal sites shall be identified at the project planning stage and the location shall be marked on the plans. But it should not restrict the contractor from disposal of the waste material at alternate site after obtaining approval of the competent authority and without any extra investment. He is expected to carry out site protection measures (including toe wall protection, slope stabilizing as may be necessary) and to ensure that no leeching of toxic materials take place. No Objection certificate from the land owner shall be in place if the land belongs to any individual. The contractor shall also ensure that the debris do not spill over to the valleys. It shall be ensured that the leaching from the fill, if any, is properly drained and do not cause damage to adjoining properties or agricultural fields.

10.3 Pre-construction Stage

10.3.1 The contractor shall identify the activities during construction, that have the potential to generate waste and work out measures for the same in the construction schedule. A sequential listing of the activities during road construction and the nature of wastes together with the possible options for reuse are specified in Table 10-2. For the disposal of excess cut and unsuitable (non-toxic) materials, the contractor shall identify the location for disposal in consultation with the community/Gram Sabha. Any toxic materials shall be disposed in existing landfill sites that comply with legislative requirements. Prior to disposal of wastes onto private/community land, it shall be the responsibility of the Contractor to obtain a No-objection Certificate (NOC) from the land owner/community. The NOC shall be submitted to the PIU prior to commencement of disposal.

Practices to avoid – waste disposal ...

- Tipping of waste into stream channels, water bodies, forests and vegetated slopes
- Non-cleaning of wastes after day's work
- Leaching of wastes
- Littering in construction camps / sites
- Storing wastes on private land.

10.3.2 The Contractor shall educate his workforce on issues related to disposal of waste, the location of disposal site as well as the specific requirement for the management of these sites.

10.4 Construction Stage

10.4.1 The contractor shall either re-use or dispose the waste generated during construction depending upon the nature of waste. The re-use of waste shall be carried out by the contractor only after carrying out the specific tests and ascertaining the quality of the waste materials used, and getting the same approved by the PIU.

10.4.2 Wastes that could not re-used shall be disposed off safely by the contractor. The contractor shall adopt the following precautions while reusing wastes for construction:

- In case of bituminous wastes, dumping will be carried out over a 60 mm thick layer of rammed clay so as to eliminate any chances of leaching.
- In case of filling of low-lying areas with wastes, it needs to be ensured that the level matches with the surrounding areas. In such a case, care should be taken that these low lying areas are not used for rainwater storage.
- The heaps of waste materials, if any, shall be properly benched and sloped to ensure that the material does not spread over the adjoining areas causing damages to property or agricultural crops. Proper toe walls may be constructed to contain the waste to remain within the identified site.

10.4.3 The waste management practices adopted by the Contractor, including the management of wastes at construction camps etc shall be reviewed by the PIU during the progress of construction.

10.5 Post Construction stage

10.5.1 After decommissioning of construction sites, the Contractor shall hand over the site after clearing the site of all debris/wastes to the PIU. The site shall be inspected by the PIU. In case of disposal of wastes on private land, certificate of Completion of Reclamation is to be obtained by the Contractor from the landowner that "the land is restored to his satisfaction". The same is to be submitted to the PIU before final payment is claimed.

Table 10-1: Type of Wastes and Scope for Re-use

S.No	Activity	Type of Waste	Scope for Possible Reuse	Disposal of Waste
I	CONSTRUCTION WASTES			
1	Site Clearance and grubbing	Vegetative cover and top soil	Vegetating embankment slopes	-
		Unsuitable material in embankment foundation	Embankment Fill	Low lying areas Land fill sites
2	Earthworks			
i	Overburden of borrow areas	Vegetative cover and soil	Vegetating embankment slopes	-
ii	Overburden of quarries	Vegetative cover and soil	Vegetating embankment slopes	-
		Granular material	Embankment Fill, Pitching	-
iii	Accidental spillages during handling	Dust	-	-
iv	Embankment construction	Soil and Granular Material	Embankment Fill	-
v	Construction of earthen drains	Soil	Embankment Fill	-
3	Concrete structures			
i	Storage of materials	Dust, Cement, Sand,	Constructing temporary structure, embankment fill	-
		Metal Scrap		Scrap Yard
ii	Handling of materials	Dust		-
iii	Residual wastes	Organic matter	Manure, Revegetation	-
		Cement, sand	Constructing temporary structure, embankment fill	-
		Metal scrap	Diversion sign, Guard Rail	-
4	Reconstruction works			
i	Dismantling of existing pavement	Bitumen Mix (broken to less than 75mm size), granular material	Sub-base	-
		Concrete	Road sub-base, reuse in concrete, fill material and as rip rap on roads	-
		Guard rail sign post, guard stone	Reuse for same	-
ii	Dismantling of cross drainage structures	Granular material & bricks	Constructing temporary structure, embankment fill	-
		Metal scrap	Diversion sign, Guard Rail	-
		Pipes	Culvert	-

S.No	Activity	Type of Waste	Scope for Possible Reuse	Disposal of Waste
5	Decommissioning of sites			
i	Dismantling of temporary structures	Granular material and bricks	Constructing temporary structure, embankment fill	-
6	Hill Roads			
i)	Hill cutting	Vegetative cover	Vegetating embankment slopes	-
		Soil & granular material	Embankment Fill	-
ii)	Clearance of slides	Vegetative cover	Vegetating embankment slopes	-
		Soil, granular material & rocky material	Embankment Fill, sub-base, gabions. Hard stones can be used as road material for WBM layers after proper screening.	-
7	Maintenance operations			
i	Desilting of side drains	Organic matter and soil	Revegetation	-
II OIL AND FLUIDS				
1	Construction machinery – maintenance and refueling	Oil and Grease	Incineration, Cooking, Illumination	-
2	Bituminous works	-	-	-
i	Storage	Bitumen	Low Grade Bitumen Mix	-
ii	Mixing and handling	Bitumen	Low Grade Bitumen Mix	-
		Bitumen Mix	Sub-base, Paving access & cross roads	-
iii	Rejected bituminous mix	Bitumen Mix	Sub-base, Paving access & cross roads	-
III DOMESTIC WASTES				
1	Construction camps	Organic waste	Manure	-
		Plastic and metal scrap	-	Scrap Yard

ECoP-11.0 Water Bodies

11.1 General

Water bodies may be impacted when the road construction is adjacent to it or the runoff to the water body is affected by change of drainage pattern due to construction of embankment. The following activities are likely to have an adverse impact on the ecology of the area:

- Earth moving
- Removal of vegetation
- Vehicle/Machine operation and maintenance
- Handling and laying of asphalt and
- Waste disposal from construction camps

11.2 Project Planning and Design Stage

11.2.1 All efforts are to be taken to avoid the alignments passing adjacent or close to water bodies. Where possible, it should be realigned away from the water body without cutting its embankment, decreasing the storage area or impairing the catchment area. Adequate drainage arrangements as per IRC:SP-20:2002 have to be provided. Stream bank characteristics and hydrology of the area are to be studied before finalizing the alignment, the profile and cross-drainage structures.

11.2.2 If it is not possible to shift the alignment and the road is located on the banks of a drinking water pond, the camber shall be away from water body. The embankment slopes shall be protected from erosion by providing slope protection measures.

11.2.3 The decision on shifting the alignment or provision of erosion control measures on embankments cutting water bodies shall be taken by the PIU. However, it shall be ensured by the PIU that no adverse affect on the water body shall take place during construction stage.

11.2.4 The PIU after an assessment of the likely impacts on the water body and review of the provisions of this ECoP shall include measures for rectifying the likely negative impact due to the construction of the rural road.

11.2.5 Complete filling of water body with soil shall not be carried out.

11.2.6 Besides the following measures, the rehabilitation plan should include activities which are required as per statutory provisions applicable in the state:

- If storage area is lost, then the water body is to be deepened / widened to regain an equivalent volume. Deepening of the pond is to be done when the pond is dry.
- Locations of erosion protection works and silt fencing should be provided to prevent sediment laden runoff caused by construction activities, entering the water body.
- Location of side drains (temporary or otherwise) to collect runoff from the embankment before entering the water body in accordance with IRC:SP-20:2002

Construction near water bodies impairs ...

- Catchment area of the water body
- Drainage system
- Flood level and water logging
- Flora and fauna dependant on the water body
- Ground water recharging
- Animal husbandry as water bodies are used by animals
- Water quality &
- Runoff (increase/decrease)

- Work program should be prepared in relation to the anticipated season of flooding/overflowing of the water body
- Reconstruction and stabilization of embankment in case it is impacted
- Drawings indicating the landscape details along with species of trees / bushes to be planted in the surrounding environs of the water body.
- Costs of rehabilitation.

11.2.7 Concurrence of the community has to be sought on the Rehabilitation Plan and community concerns, if any have to be incorporated into the plan by the PIU.

11.2.8 Cost estimates to mitigate impacts on water bodies through the rehabilitation plan or otherwise shall be incorporated into the DPR.

Steps for addressing impacts on Water Bodies in DPR
<p>Step 1: Capture following details during Transect Walk:</p> <ul style="list-style-type: none"> • Location of pond in relation to existing alignment. • Approximate size and depth of the water body in meters ‘m’. • Designated use of the water body – Household Use/Drinking/Irrigation. • Visual inspection of the quality of water. <p>Step 2: Consult people regarding alternate routes that were devised to avoid the pond. If alternate routes are not available, consent of the villagers is to be sought for affecting the pond and also the measures that would be taken to mitigate the impacts.</p> <p>Step 3: If impacting the pond, the extent of impact is to be clearly indicated on a separate drawing showing blown up portion of the pond.</p> <p>Step 4: Prepare rehabilitation plan if water body is getting adversely impacted.</p> <p>Step 5: Precautionary measures while working close to the water body are to be incorporated into the Detailed Project Report .</p>

11.3 Pre-construction stage

11.3.1 When there is interruption to regular activities of villagers near water body due to construction or rehabilitation work, following are the Contractor’s responsibilities:

- Restriction on use of water during construction, if any, should be intimated to the community in advance.
- Alternate access to the water body is to be provided in case there is interruption to use of exiting access. The access provided should be convenient for use of all the existing users whether community or cattle
- If the water body affected is a drinking water source for a habitation, alternate sources of water are to be provided to the users during the period for which its use is affected.

Working near Water Bodies – Precautions
<ul style="list-style-type: none"> • Avoid locating roads on pond embankment • Collect road runoff before entering the water bodies • Runoff to be filtered of sediments before letting into water bodies • Avoid debris disposal into water bodies • Avoid disposal of oil/grease/other contaminants into water bodies

11.4 Construction Stage

- 11.4.1 It should be ensured by the contractor that the runoff from construction site entering the water body is generally free from sediments.
- 11.4.2 Silt/sediment should be collected and stockpiled for possible reuse as surfacing of slopes where they have to be re-vegetated.
- 11.4.3 Cutting of embankment reduces the water retention capacity and also weakens it, hence:
- The contractor should ensure that the decrease in water retention should not lead to flooding of the construction site and surroundings causing submergence and interruption to construction activities.
 - Any perceived risks of embankment failure and consequent loss/damage to the property shall be assessed and the contractor should undertake necessary precautions as provision of toe protection, erosion protection, sealing of cracks in embankments. Failure to do so and consequences arising out of embankment failure shall be the responsibility of the contractor. The PIU shall monitor regularly whether safe construction practices near water bodies are being followed.
- 11.4.4 Alternate drain inlets and outlets shall be provided in the event of closure of existing drainage channels of the water body.
- 11.4.5 Movement of machinery and workforce shall be restricted around the water body, and no waste from construction camps or sites shall be disposed into it.

11.5 Post construction stage

- 11.5.1 The precincts of the water body have to be left clean and tidy with the completion of construction.
- 11.5.2 PIU will check if drainage channels of adequate capacity, have been provided for the impacted water body.

ECoP-12.0 Drainage

12.1 General

- 12.1.1 Drainage is designed for and installed on roads to direct surface or subsurface flow away from structural elements of a roadway and then to convey it to a safe outfall without damage to the road structure, adjoining property or agricultural fields.
- 12.1.2 A road with good drainage is a good road. Inadequate and faulty drainage arrangements result in obstruction to natural drainage pattern. The problem is further aggravated in the low-lying areas and flood plains receiving high intensity rainfall, which can lead to the instability of embankment, damage to pavement, sinking of foundation, soil erosion, safety hazards and disruption in traffic. Provision of cross-drainage and longitudinal drainage increases the life of the road and consequently reduces water logging and related environmental impacts. The functioning of the drainage system is therefore a vital condition for a satisfactory road.
- 12.1.3 However, construction or up-gradation of CD structures and longitudinal side drains is likely to increase sediments, scour the banks, change water level and flow, and affect the ecology of the surrounding area.
- 12.1.4 The present code seeks to address the environmental concerns related to drainage aspects during different stages of the project execution. Engineering aspects brought out in this chapter are for sake of clarity. The design shall however be covered by relevant IRC codes / guidelines.

12.2 Project Planning and Design

- 12.2.1 It is mandatory to prepare a drainage plan especially when finalization of roads in hilly regions. The drainage plan shall clearly identify longitudinal drains, outfalls, existing and proposed drainage arrangements
- 12.2.2 Drainage shall be broadly taken up as (i) Cross-Drainage and (ii) Longitudinal Drainage both surface & sub-surface drainage. The alignment shall be routed such that minimum drainage crossings are encountered. Also the geometric design criteria as per IRC:SP-20:2002, for effective surface drainage should be ensured.
- 12.2.3 All drains crossing the alignment shall be identified on site and marked on map while undertaking transect walk. Basic information on the width of channel, frequency of traffic holdup and flow would provide inputs into screening of alternate alignments as well as fixing the alignment. Consultations with the community shall provide information on the HFL in the area.
- 12.2.4 In areas of high and medium intensity rainfall (>400 mm/year), flood prone areas and hilly areas design of CD structures shall be prepared to avoid scouring on the downstream side and afflux on the upstream side. In areas where the Technical Audit identifies likely incidences of flooding/scouring, additional hydrological studies will need to be conducted and designs updated accordingly. For bridges and other drainage structures the studies shall be conducted as per IRC: SP-13: 1973 “Guidelines for the Design of Small Bridges & Culverts” and IRC: SP-33:1989 “Guidelines on Supplemental Measures for Design, Detailing & Durability of Important Bridge Structures”.
- 12.2.5 Design of cross-drainage structures shall be based on the inputs from the hydrological studies as per clause 12.2.3 and in other areas, the C-D structure design shall be as per IRC:SP-20:2002.

12.2.6 Design of C-D structure shall be such that:

- Normal alignment of the road is followed even if it results in a skew construction of culverts and stream bank protection are incorporated
- Afflux generated is limited to 45 cm in plains with flat land slopes as it may cause flooding of upstream areas
- The fish friendly – fish passage is not interrupted either in upstream or downstream direction
- Adequate openings are provided along with adequate scour protection measures for stream bank, roadway fill as head walls, wing walls and aprons as per provisions of IRC guidelines.
- Reinforced road bed (of concrete or rock) for protection against overflow in case of low water crossing (fords/causeways) is included
- The design of C-D structure should have steps leading to the bed of the drainage channel, for regular inspection of the sub-structure.

12.2.7 Schedule of construction of C-D structures should preferably be carried out during dry months to avoid contamination of streams.

12.2.8 Longitudinal drains are to be designed to drain runoff from highest anticipated rainfall as per hydrological analysis in high rainfall areas (annual rainfall > 1000 mm) and hill areas (refer Appendix “Heaviest Rainfall in One Hour (mm) IRC:SP-13: 1998, “Guidelines for the Design of Small Bridges and Culverts” for rainfall data). For design of longitudinal drains in other areas, the design shall be as per IRC: SP-20: 2002.

12.2.9 Outfall of the roadside drains shall be into the nearby stream or culvert or existing depressions in the ground. The outfall should be at such a level that there would be no backflow into the roadside drain. Wherein pond/low lying areas exist in the vicinity, the flow may be diverted into them for possible ground water recharge.

12.2.10 In case of Hilly areas, if no natural drainage system is found appropriate for roadside drain outfall, water-harvesting structures shall be considered to collect the runoff. The location shall be determined based on the size of the structure (which in turn depends on the discharge anticipated) imperviousness of the strata and willingness of the landowner who would be utilizing the collected water. These shall be determined by the PIU in consultation with the landowner during project preparation stage.

12.2.11 The roadside drains in high rainfall areas (annual rainfall > 1000mm) and in hill areas, shall be lined to protect from runoff of high velocities. Suitable cross-drainage culverts or scuppers, at least three per kilometer, shall be provided to direct the discharge to the valley side. The outfall of these culverts shall be suitably canalized so that the discharge does not cause erosion or damage to the agricultural fields or orchards on the valley side

12.2.12 In case of high embankment or bridge approaches, lined channels shall be provided to drain the surface runoff, prevent erosion from the slopes and avoid damage to shoulders and berms. Detailed specifications shall be in accordance with IRC SP 42:1992, Guidelines on Road Drainage and IRC: SP-20: 2002, Rural Road Manual.

12.3 Pre-Construction Stage

12.3.1 Following measures are to be undertaken by the contractor prior to the commencement of CD/Bridge construction in case it affects the surface or sub surface flow through the stream / nallah:

- The downstream as well as upstream user shall be informed one month in advance
- The contractor shall schedule the activities based on the nature of flow in the stream.
- The contractor should inform the concerned departments about the scheduling of work. This shall form part of the overall scheduling of the civil works to be approved by PIU.

- Erosion and sediment control devices if site conditions so warrant, are to be installed prior to the start of the civil works.
- Interceptor drains to be dug prior to slope cutting to avoid high runoff from slopes entering construction sites in case of hill roads
- Runoff from temporary drains and interceptor drains to be directed into natural drainage system in hill roads
- In case of up-gradation of the existing CD Structures, temporary route / traffic control shall be made for the safe passage of the traffic, depending upon the nature of the stream and volume of traffic.
- All the safety/warning signs are to be installed by the contractor before start of construction

12.3.2 In case of utilization of water from the stream, for the construction of the CD structures, the contractor has to take the consent from the concerned department (refer ECoP-8.0, “Water for Construction”).

12.4 Construction Phase

12.4.1 Drainage structures at construction site shall be provided at the earliest to ensure proper compaction at the bridge approach and at the junction of bridge span and bridge approach.

12.4.2 In hill areas sub-surface drains, if required, shall be provided immediately after cutting the slopes and forming the roadbed (sub grade).

12.4.3 Velocity of runoff to be controlled to avoid formation of rills/gullies as per ECoP-9.0, “Slope stability & erosion control”

12.4.4 While working on drainage channels, sediment control measures if required shall be provided. In such case Silt fencing / brush barrier (as per the detailed specifications given in Box 9-3 and 9-5 respectively of ECoP-9.0, “Slope Stability & Erosion Control”) shall be provided across the stream that carries sediment.

12.4.5 Safety devices and flood warning signs to be erected while working over streams and canals.

12.5 Post Construction

12.5.1 Inspection and cleaning of drain shall be done regularly to remove any debris or vegetative growth that may interrupt the flow.

12.5.2 HFL should be marked as per hydrological data on all drainage structures

12.5.3 Temporary structures constructed during construction shall be removed before handing over to ensure free flow through the channels.

12.5.4 The piers and abutments should be examined for excessive scour and make good the same, if required.

12.5.5 In case of Causeway, following aspects shall be taken into consideration:

- Dislocation of stones in stone set pavements, scouring of filler material due to eddy currents.
- Floating debris block the vents. In case of large amount of floating material, debris arrestor shall be provided in upstream side.
- Damage to guide stones, information boards shall be inspected and replaced accordingly.

12.5.6 Schedule of inspection shall be drawn up for checking cracks, settlements and unusual backpressures. It must be ensured that all the rectification shall be undertaken as and when required. Following are broadly the items to be checked:

- Settlement of piers/abutments & settlement of approach slabs have to be checked
- Cracks in C-D structures or RCC slabs
- Drainage from shoulders to be ensured
- Ditches & drains to be kept clean of debris or vegetation growth
- Repairs to parapet of culverts whenever required are to be undertaken

ECoP-13.0 Construction Plants and Equipment Management

13.1 General

13.1.1 During execution of the project, construction equipments, machinery and plants always have impact on the environment. The impact can be due to the gaseous emissions, dust, noise and oil spills that concern the safety and health of the workers, surrounding settlements and environment as a whole. This code of practice describes the activities during the project stages where pollution control measures are required.

13.2 Project Planning and Design Stage

13.2.1 Selection criteria for setting up a plant area and parking lot for equipments and vehicles shall be done as per siting criteria for construction camp specified in ECoP-3.0, “Construction Camps”

13.3 Pre-construction Stage

13.3.1 The Contractor must educate the workers to undertake safety precaution while working at the plant / site as well as around heavy equipments as per Clause 14.3.2, Section 14.3, ECoP-14.0, “Public and Worker’s Health & Safety”.

13.3.2 Before setting up the crusher and hot-mix plant the contractor shall acquire “Consents” from the State Pollution Control Board as per Air (Prevention and Control of Pollution) Act, 1981, Chapter IV, Section 21.

13.3.3 The Contractor must ensure that all machinery, equipments, and vehicles shall comply with the existing Central Pollution Control Board (CPCB) noise and emission norms, as applicable.

13.3.4 The Contractor shall submit a copy of the approvals and PUC Certificates, as applicable to the PIU before the start of relevant work.

13.4 Construction Stage

13.4.1 The Contractor shall undertake measures (as mentioned in table below) to minimize -the dust generation, emissions, noise, oil spills, residual waste and accidents at the plant site as well as during transportation of material to construction site.

Table 13-1: Measures at Plant Site

Concern	Causes	Measures
Dust Generation	Vehicle Movement	<ul style="list-style-type: none"> • Water sprinkling • Fine Materials shall be Transported in Bags or Covered by Tarpaulin during Transportation • Tail board shall be properly closed and sealed
	Crushers	<ul style="list-style-type: none"> • Water Sprinkling
	Concrete-Mix Plant	<ul style="list-style-type: none"> • Educate the workers for following good practices while material handling
Emissions	Hot-Mix Plant	<ul style="list-style-type: none"> • Site Selection as per Clause 6.5.2, Section 6.5, IRC’s Manual for Construction & Supervision of Bitumen Work • Regular maintenance of Dust Collector as per manufacture’s recommendations
	Vehicles	<ul style="list-style-type: none"> • Regular maintenance as per manufacture’s recommendation
	Generators	<ul style="list-style-type: none"> • Exhaust vent of long length

Concern	Causes	Measures
Noise	Heavy Load Vehicles	• Exhaust silencer, Regular maintenance as per manufacture schedule
	Crushers	• Siting as per ECoP-3.0, “Construction Camps”
	Generators	• Shall be kept in a room that is acoustically enclosed. ⁴ There shall be regular maintenance as per manufacture’s recommendation.
Oil Spills	Storage and Handling	• Good practice, • ECoP-10.0, “Waste Management”
Residual waste	Dust Collector and Pits	• ECoP-10.0, “Waste Management”
Concrete waste	Concrete-Mix plant	• ECoP-10.0, “Waste Management”
Bitumen and bitumen mix	Hot-mix Plant	• ECoP-10.0, “Waste Management”
Stone chips	Crushers	• ECoP-10.0, “Waste Management”
Safety	Trajectory of Equipments	• Caution Sign, awareness among workers
	Movable Parts of Equipments	• Caution Sign, awareness among workers
	Plant Area / Site	• Caution Sign, Safety Equipments
	Accidents / Health	• First Aid Box and Emergency Response Plan
	Break down of vehicles	• Arrangement for towing and bringing it to the workshop

13.4.2 During excavation, water sprinkling shall be done to minimize dust generation.

13.4.3 Frequent water sprinkling shall be done on the haul roads to minimize dust generation. In case of loose soils, compaction shall be done prior to water sprinkling.

13.4.4 Cautionary and informatory sign shall be provided at all locations specifying the type of operation in progress.

13.4.5 The contractor must ensure that there is minimum generation of dust and waste while unloading the materials from trucks.

13.4.6 The equipments, which are required to move forward and backward, shall be equipped with alarm for backward movement. It shall be ensure that the workers shall remain away from the working areas at such times.

13.4.7 The PIU shall carry out periodic inspections to ensure that all the

Safety Measures During Bitumen Construction Work...

- The Contractor shall ensure that bitumen storing, handling as well as mixing shall be done at hot-mix plant or designated areas⁵ to prevent contamination of soil and ground water.
- Skilled labour shall be used while hand placing the pre-mixed bitumen material. The hand placing of pre-mixed bituminous material shall be done only in following circumstances:
 - For laying profile corrective courses of irregular shape and varying thickness
 - In confined spaces where it is impracticable for a paver to operate and
 - For filling potholes
- The Contractor shall provide safety equipments i.e. gumboots and gloves to the workers while handling bitumen.
- While applying Tack Coat, spraying of bitumen shall be done in the wind direction. The labour shall wear jacket while spraying the bitumen.
- All the bituminous work shall be done as per IRC’s Manual for Construction and Supervision of Bituminous Works.

⁴ As per Environmental (Protection) Rules, 1986, Rule 3, Schedule – I, Item 83 B.

⁵ Designated area refers to paved surfaces and barren parcels of land, with adequate drainage and disposal system. It must be ensure that these are away from agriculture land, water body and other sensitive areas.

pollution control systems are appropriately installed and comply with existing emission and noise norms.

13.5 Post-construction Stage

- 13.5.1 In case any haul road is damaged while transporting construction material or wastes, the contractor shall restore the road to its original condition.
- 13.5.2 The PIU must ensure that the decommissioning of plant shall be done in environmentally sound fashion and the area to brought to its original state.

ECoP-14.0 Public and Worker's Health and Safety

14.1 General

14.1.1 The safety and health of the workers and the public is impacted due to the hazards created during the construction of road. This code of practice describes the measures that need to be taken to mitigate the impacts.

14.2 Project Planning and Design Stage

14.2.1 To address the safety concerns to road user during operational phase, the DPR shall contain the following:

- Selection and location of regulatory as well as informatory signs as per IRC: 67-2001, depending upon the geometry of the road.
- In case of hill roads, provision of passing places and parapet wall shall be included in road design.

14.3 Pre-construction stage

14.3.1 In order to incorporate public health and safety concerns, the PIU and the Contractor shall disseminate the following information to the community:

- Location of construction camps, borrow areas and quarry areas.
- Extent of work
- Time of construction
- Diversions, if any
- Involvement of local labours in the road construction
- Health issues - water stagnation, exposure to dust, communicable diseases
- Location and use of first aid kits
- Location, names, and phone numbers to the nearest clinic/ hospital /doctor

14.3.2 The Contractor must bring awareness to the workers to undertake the health and safety precautions. Through regular meetings, as may be necessary, contractor shall generate awareness amongst the workers regarding:

- Personal safety measures and location of safety devices.
- Interaction with the host community
- Protection of environment with respect to:
 - Trampling of vegetation and cutting of trees for cooking
 - Restriction of activities in forest areas, including hunting
 - Water bodies protection
 - Storage and handling of materials
 - Disposal of construction waste

Safety Concerns on...

General Public due to:

- Improper scheduling of construction activities especially near the settlements and sensitive areas
- Parking of equipments and vehicles at the end of the day is likely to cause accidents to the public especially during night hours.
- Transportation of uncovered loose material or spillage of material increases the chances of accidents to road users and surrounding settlements.

Workers due to:

- Improper handling of materials like bitumen, oil and other flammable material at construction sites, likely to cause safety concerns to the workers.
- Lack of safety measures such as alarm, awareness and safety equipment result in accidents, especially working with or around heavy machinery / equipments.

14.4 Construction Stage

14.4.1 During the progress of work, following are the safety requirements that need to be undertaken by the contractor at the construction site:

- Personal safety equipments (such as footwear, gloves and eye protection devices, helmets etc.) for the workers.
- Additional provisions need to be undertaken for safety at site:
 - Adequate lighting arrangement
 - Adequate drainage system to avoid any stagnation of water
 - Lined surface with slope 1:40 (V:H) and provision of lined pit at the bottom, at the storage and handling area of bitumen and oil, as well as at the location of generator (grease trap).
 - Facilities for administering first aid

14.4.2 The following measures need to be adopted by the contractor to address public safety concerns:

- The Contractor shall schedule the construction activities taking into consideration factors such as:
 - Sowing of crops
 - Harvesting
 - Local hindrances such as festivals etc.
 - Availability of labour during particular periods
- All the cautionary signs as per IRC: 67-2001 and traffic control devices (such as barricades, etc) shall be placed as soon as construction activity get started and shall remain in place till the activities get completed.
- Following case specific measures need to be followed during the progress of the activity:
 - In case of blasting, the Contractor must follow The Explosives Rules, 1983.
 - If construction of road is within the settlement, the contractor must ensure there shall not be any unauthorized parking as well as storage of material, adjacent to road.
 - Approved methods to be used to prevent breeding of mosquitoes and other disease-causing organisms, at all the water logging areas.

FIRST AID FACILITIES

- First Aid Kit, distinctly marked with Red Cross on white back ground and shall contain minimum of following:
 - 6 small-sterilized dressings
 - 3 medium and large sterilized dressings
 - 1 (30 ml.) bottles containing 2 % alcoholic solution of iodine
 - 1(30 ml) bottle containing salvolatile
 - 1 snakebite lancet
 - 1 pair sterilized scissors
 - 1 copy of first-aid leaflet issued by the Director General, Factory Service & Labour Institute, Government of India
 - 100 tablets of aspirin
 - Ointment for burns
 - A suitable surgical antiseptic solution
- Adequate arrangement shall be made for immediate recoupment of the equipments, whenever necessary.
- A trained personnel incharge of first aid treatment to be readily available during working hours at construction site
- Suitable transport to the nearest approachable hospital should be made available.

14.4.3 The PIU shall carry out periodic inspections in order to ensure that all the measures are being undertaken as per this ECoP.

14.5 Post-construction Stage

14.5.1 During this stage, a major concern is on road user safety. Following are the measures that need to be undertaken by the PIU to ensure safer roads:

- Inspection and maintenance of installed regulatory and informatory signs.
- Ensure that the location of signage does not obstruct the visibility
- In case of hill roads, maintenance of parapet wall as well as of overtaking zones.

14.5.2 The construction site shall be cleaned of all debris, scrap materials and machinery on completion of construction for the safety of public and road users, as per the ECoP-3.0, "Construction Camp" and ECoP-10.0, "Waste Management."

ECoP-15.0 Cultural Properties

15.1 General

15.1.1 The cultural properties located close to the road are likely to be impacted by the road construction. However, so far in the PMGSY programme implementation, most of the properties have been protected/saved during finalization of the alignment itself.

15.2 Project Planning and Design Stage

15.2.1 Measures for mitigation of impacts on cultural properties during project preparation shall be as per the following steps:

- Identification of locally significant cultural properties should be done
- Assessment of likely impacts on each cultural property due to project implementation
- The extent of impact on the identified culture property should be assessed and possible measures for avoidance should be devised based on the site investigation.

15.2.2 In case impact is not avoidable, identification of alternative routes or possibility of relocation of the culture property shall be assessed in consultation with the local public.

15.2.3 In case a relocation is unavoidable, the site for relocation should be identified in consultation with local people and the size of relocated structure should at least be equal to the original structure.

15.2.4 A detailed design of the relocated structure and its site plan along with the necessary BoQ are to be presented DPR.

15.2.5 The relocation shall be carried out before the start of the road work.

15.2.6 It must be ensured by the PIU that the required BoQ is incorporated into the contract document.

Information to be collected...

- Location
- Direction (North/ South/East/West) With Respect to Road
- Distance of the structure from existing centerline of the road
- Type of Property eg: temple/mosque/shrine/dargah etc
- Plan of the structure
- Importance of the structure – historical/social/archeological
- Ownership of the property
- Probable loss to the property
- Specific periods/durations in which large congregations as festivals/mela take place causing hindrance to vehicular movement
- Choice of community, issue of relocation

15.3 Construction Stage

15.3.1 Major impacts on the properties during this stage are mainly due to movement of construction machinery as well as due to construction activity near the cultural property. Following are precautionary measures that need to be undertaken by the contractor while working near these structures:

- Provision of temporary barricades to isolate the precincts of the cultural property from the construction site to avoid impacts.
- Restrict movement of heavy machinery near the structure.
- Avoid disposal or tipping of earth near the structure.
- Access to these properties shall be kept clear from dirt and grit.

15.3.2 During earth excavation, if any property is unearthed and seems to be culturally significant or likely to have archeological significance, the same shall be intimated to the Engineer. Work shall

be suspended until further orders from PIU. The State Archeological Department shall be intimated of the chance find and the Engineer shall carry out a joint inspection with the department. Actions as appropriate shall be intimated to the Contractor along with the probable date for resuming the work.

15.3.3 The PIU must ensure that the contractor implements the precautionary measures as suggested.

15.4 Post Construction Stage

15.4.1 Immediately after completion of construction, the Contractor will affect clearance of the precincts of cultural properties.

15.4.2 In case access to any of the cultural properties is severed during construction, it needs to be restored at the earliest.

15.4.3 The PIU shall certify relocated structure construction quality and restoration of access, as the case may be, before payment is made to the Contractor.

ECoP-16.0 Tree Plantation

16.1 General

16.1.1 PMGSY guidelines (Section 21.4) specifies that the state governments would take up the planting of fruit bearing and other suitable trees, on both sides of the roads from their own funds. Besides improving aesthetics and ecology of the area, the trees provide fuel wood, act as noise barriers, provide visual screen for sensitive areas and also generate revenue by sale of its produce. However, certain precautions must be taken in design of avenue or cluster plantation so that the trees do not have an adverse impact on road maintenance and/or on safety of the road users. This code of practice elaborates on the approach towards planting trees on PMGSY roads. Emphasis has been laid on a greater involvement of communities and Gram Panchayats in planting and maintenance of roadside trees.

16.2 Project Planning and Design Stage

16.2.1 During alignment finalization, due consideration shall be given to minimize the loss of existing tree cover, encroachment of forest areas / protected areas etc as specified in ECoP-1.0, "Project Preparation". Tree felling, if unavoidable, shall be done only after compensatory plantation of at least three saplings for every tree cut is done. This shall be carried out by the PIU immaterial of the legal requirements of the state.

Plant trees along roads where there is...
<ul style="list-style-type: none">• Availability of land for planting• Availability of water• Willingness of PRI to nurture the saplings

16.2.2 A roadside plantation plan may be prepared by the PIU as part of the DPR, and finalised in consultation with the State Forest Department and PRI. The plantations shall be in accordance with the IRC:SP:21-1979 Manual on Landscaping and IRC:66-1976. The plan may be in the form of avenue trees or cluster plantation. It should be ensured that plantation is carried out only in areas where water can be made available during dry seasons and the plant can be protected during the initial stages of their growth. The species shall be identified in consultation with officials of forest department, giving due importance to local flora. It is recommended to plant mixed species in case of both avenue or cluster plantation. The saplings for plantation shall be supplied by the Forest Department at a nominal cost or the community can develop its own nursery.

16.2.3 Consultations shall include the role of the PRIs in maintaining and managing the trees to be planted in the project. A MoU shall be signed between the Gram Panchayat, PIU and Forest Department towards maintenance of the trees, and empowering the PRIs to be entitled to any revenue generated out of these trees. Alternately the need for close cooperation shall be covered by a government order. It shall be the responsibility of the Gram Panchayats through the Development Committees to work out institutional mechanisms for managing the plantation and upkeep of trees.

16.2.4 The plantation strategy shall suggest the planting of fruit bearing trees and other suitable trees. Development of cluster plantations will be encouraged in the Gram Sabha lands, at locations desired by the community. The choice of species will be based on the preferences of the community.

Do not plant trees ...
<ul style="list-style-type: none">• Within the line of sight around junctions• On the inside of curves• Within 5 m of the proposed centre line

16.2.5 In arid areas, shelter belt plantation shall be propose as wind breaks, through plantation of local hardy shrubs and grass species in preference to plantation of trees. The location of these belts

plantation shall be decided by the PIU in consultation with the PRI and State Forest Departments after considering the wind direction, velocity and likely movement of sand dunes.

- 16.2.6 The nurseries shall be developed as per landscape plan and subsequent upkeep. The maintenance of trees shall be the responsibility of PRI or the authority designated by them. The expenditure can be met either from their own resources or wage component from any employment generating programme such as National Rural Employment Guarantee Act (NREGA) and Sampoorana Grameen Rozgar Yojana.

16.3 Post-construction stage

- 16.3.1 Planting of saplings from the nurseries as per the plantation plan and the subsequent maintenance of the trees planted may be carried out by the PRI, with its own funds. Planting shall be undertaken immediately after rainy season or initial weeks of spring. The activities to be taken up by the PRI as part of maintenance shall include (i) cutting/lopping branches up to a height of 2.5m above ground level to ensure visibility (ii) Removal of dead wood from the roadway and storing away from roads, and (iii) Weed cutting from shoulders and keeping the shoulders free from any growth of vegetation. In addition, the PRI is to ensure a healthy survival rate by planting replacement saplings in cases where the survival rate is less than 80%.
- 16.3.2 Watering of trees during the initial period of two to three years shall be the responsibility of the PRI or the agency designated by it. Final payment, if any, shall be on the basis of the number of trees surviving at the end of three years of initial plantation. The shoulders of the road shall be kept clear of weeds or any undesirable undergrowth, which may hinder free flow of traffic.
- 16.3.3 It needs to be ensured that the branches of the trees do not obstruct clear view of the informatory and caution signs.

Note: The species of trees to be planted has not been suggested, as this should be decided in consultation with the State Forest Department for the particular region.

ECoP-17.0 Managing Induced Development

17.1 General

17.1.1 Rural lands have a distinct character consisting of productive farmlands with natural areas and limited residential settlement. Development allowed to grow along the village roads, unless planned and regulated, has the potential to generate traffic and pedestrian movements that can lead to unsafe traffic conditions. Lack of planning controls in the rural areas has allowed roadside development, ranging from individual commercial establishments to continuous stretches of ribbon developments. This code of practice provides measures for regulating the land uses along the roads and tackling induced developments likely along the PMGSY roads. The measures suggest a greater involvement of the Village Panchayats and the Road Authorities for the PMGSY roads. The measures suggested are in accordance with the roles and responsibilities of the PRIs as suggested in the 73rd Amendment Act, 1992 and the respective State Panchayat Acts.

17.2 Project Planning and Design Stage

17.2.1 As part of the design stage, the PIU may identify areas that are susceptible to induced development impacts. These locations will be finalized in consultation with the Gram Sabha. It is suggested that the PIU may take initiative in educating the community on the safety issues due to ribbon development.

17.2.2 The design of access points to the road shall as far as possible conform to certain minimum geometric standards.

Locations vulnerable to induced development...

- Lands within 50m of junctions
- Agricultural lands within 100m of settlements
- Stretches within 100m of temples, weekly fairs and locations of community mass gatherings

17.3 Operation stage

17.3.1 The Gram Panchayat / Road authority/ village council which ever is applicable, shall lay down restrictions on building activities along the rural roads. Towards this, the recommended standards for building lines and control lines may be followed as stipulated in Table 2.4 of IRC: SP: 20-2002.

17.3.2 Development of Residential Sites outside Existing Settlement: Apart from the adoption of the recommended standards for building lines, the Gram Sabha/ village council shall encourage local development through education to the communities to construct property with setback from the road rather than on the road.

17.3.3 Development of Repair Shops, Petty Shops at Junctions: A road junction, especially at locations where the village road meets a district road is a typical site where such repair shops, petty shops tend to come up. The Gram Panchayat/ village council or other regulatory authority shall ensure that no such shops or structures come up within the line of sight. Areas for their development

Possible development activities along PMGSY roads...

- Residential sites
- Repair shops & Petty shops
- Commercial establishments within settlements
- Basic amenities – health, education, water pumps etc
- Village level public buildings
- Selling of produce, informal markets
- Developments around specific areas as water bodies, cultural properties
- Formal markets & agro-processing units

shall be demarcated and parking facilities shall be provided to encourage them developing away from the road.

17.3.4 While deciding upon the location of community assets, the following preventive measures to address possible induced impacts shall be taken up:

- The area around the bus stops has the potential to induce growth of kiosks and petty shops. While this is unavoidable and desirable (to minimize the impact on the road), such growth needs to be encouraged away from the road.
- Community sources of water such as hand pumps are generally sited on the shoulders. It shall be the responsibility of the Gram Sabha to identify lands outside the RoW and identify any suitable gram Sabha land accessible from the road. This approach would achieve (i) Safety and (ii) Damage to the road due to water logging, usually around such water sources.

17.3.5 The Gram Sabha shall follow the principles given hereunder while planning and developing small markets / fairs, which include the selling of agricultural produce:

- Restricting or planning the activity to one side of the road to minimise pedestrians crossing the road
- Provide parking areas if necessary, and clearly delineating the parking areas from the road
- Providing a good visibility on the approaches to the market area.
- These sites should not be within 150m of the access or egress points of a major junction.
- The commercial areas should be preferably planned lateral to the road than in parallel direction

17.3.6 In each state road boundary width and control width will be fixed by the road authority after its declaration as a scheduled road. The information about these parameters should be made available to the community and they be motivated towards avoidance of encroachments on the roads. Encroachments along the road length may become cause of accident by reducing sight distance and affect free flow of traffic.

17.3.7 The Gram Sabha/ Village Council shall take up appropriate measures towards the removal of encroachments onto the public land.

17.3.8 The concerns of the communities, about the traffic speed and/or volume through the villages are usually addressed through traffic calming schemes such as road humps or speed breakers/rumble strips along the road. The PIU, where applicable shall incorporate traffic calming schemes in the design aimed at changing the driver's visual perception of the road environment, as they enter the village, so that they adjust their driving style to better navigate any obstacles encountered. However, such calming devices shall be provided along with provision of adequate signage and pavement marking.

ECoP-18.0 Environmental Monitoring and Audit

18.1 General

18.1.1 Environmental Monitoring provides a systematic review of planning, designing, construction practice and operation activities that may have adverse impact on the surrounding environment. Environmental monitoring enables identification of:

- Degradation/improvement of surrounding ecology
- Damage to surrounding habitation and
- Extent of compliance with ECoPs and other regulatory provisions

18.1.2 PIU should assess whether construction activities comply with environmental standards and other regulatory requirements, by monitoring and conducting an Environmental Audit. These need to be carried out on a periodic basis.

Aspects for Audit...

- Alignment finalization
- Site preparation
- Material management
- Drainage
- Slope protection and erosion control
- Water management and economy of use
- Waste generation, management and disposal
- Tree cutting and compensatory plantation
- Siting construction camps, plants and equipments
- Induced Development

18.2 Monitoring Procedure

18.2.1 PIU/Technical Examiner shall be responsible for conduct of the periodical environmental monitoring. It will be conducted in phases corresponding to the phases of the project such as (i) DPR Preparation, (ii) Pre-Construction (iii) Construction and (iv) Post Construction. Concurrent audit can be undertaken along with quality assurance checks that need to be conducted by the Technical Examiner.

18.2.2 Environmental audit shall be as per the Checklists 1 and 2 provided in the ECoP. Audit for project preparation, pre-construction and post-construction stages shall be one time, while for construction stage, quarterly monitoring shall be undertaken. Audit for DPR preparation as per Checklist 1 will be conducted by the PIU and for the other project stages, audit shall be conducted by the TA consultant. The audit findings shall be reported to the State implementing Authorities.

Benefits of Audit

- Determines the efficiency of practices followed during execution of the work
- Determines the performance of environmental measures suggested
- Assesses the need to undertake additional measures to minimize any adverse environmental impacts identified during the project period
- Audit develops the potential of waste minimization and adoption of recycling and reuse of waste.
- Assist in complying with local, state and national laws and regulation

Checklist 1: Audit Checklist for DPR Preparation

Sl. No.	Items for inclusion in DPR	Response				Attachments
		Yes	No	NA	Indicate number	
I. Transect Walk						
1	Is transect walk conducted for finalizing the alignment?					Map of Transect Walk
II. Initial Consultations						
2	Are consultations conducted with community village council before alignment finalisation					Suggestions received from community
2.1	Suggestions received on the proposed alignment					Write up on suggestions received and response of PIU
2.2	Consent of land owners towards voluntary land uptake.					Attach gift deeds/MoU
3	Are suggestions received from community been incorporated into design					
3.1	Only few suggestions are incorporated					Reasons for not incorporating suggestions from community
3.2	Are reasons for not incorporating suggestions been communicated to the community					
3.3	Has action been taken for making necessary corrections in lad records?					Indicate reference
III. Identification of PAPs						
4	Are type and extent of losses due to project identified					
5	Are PAPs due to the project identified					List of PAPs and loss suffered due to the project
6	Are vulnerable PAPs identified with respect to following:					
6.1	BPL					
6.2	Marginal land owner (less than 3-1/8 acres and losing 10% of residual land)					
6.3	WHH					
6.4	SC/ST					
6.5	Handicapped					
7	Are grievances reported					List of grievances and PAPs
7.1	Type of concerns or grievances					Mechanism for grievance redressal
7.2	Residual grievances if any					Reasons for non addressal
IV. R&R actions						
8	Are provisions for losses been made					Details of Entitled PAPs and provisions
8.1	Are provisions of alternate land site made for the identified entitled/vulnerable PAPs losing land and structure					Details of PAPs and land provided
8.2	Are provisions made for alternate land for ST in scheduled areas under PESA					Details of PAPs and type of provisions as per PESA
8.3	Are provisions made for inclusion of PAPs losing land/shelter/livelihood under any ongoing Rural Development scheme					Details of PAPs and schemes under which they are included

Sl. No.	Items for inclusion in DPR	Response				Attachments
		Yes	No	NA	Indicate number	
8.4	Are provisions made for illegal occupants					List of encroachers/squatters and provisions
9	Any consultation during implementation work					Type of consultation & issues addressed
9.1	Migrant labourers and construction camps					
9.2	Health issues including HIV/AIDS					
V. Environmental Clearances						
10	Environmental clearances to be obtained, if required					Copy of Clearance obtained
10.1	SPCB					Copy of application form submitted if clearance is pending
10.2	Forest Department					
10.3	MoEF if required					
VI. Surveys Conducted						
11	Are detailed surveys conducted for the project					Information presented in DPR
11.1	Geological Studies					
11.2	Hydrological Studies					
11.3	Topographical Studies					
11.4	Was peg marking carried out to delineate the proposed alignment					
VII. Loss of common property resources						
12	Are provisions made to community losing common property or assets, if any					Type of loss and arrangements made
13	Are provisions for relocation of cultural properties been made					
VIII. Material source identification, extraction and rehabilitation						
14	Are provisions made in specifications for identification of borrow areas to reduce cost and use waste materials					
15	Are provisions made for rehabilitation of borrow areas in the DPR/Specifications					
16	Were sources of alternate materials explored or provisions made for utilizing them, incase lead for stone ballast is excessive, to reduce cost and use waste materials.					Properties of alternative materials and extent of utilization
17	Is material from existing quarries in sufficient quantities for the project					
17.1	If answer to No. 17 is no, then are arrangements made for identification, extraction, rehabilitation of new quarries as per ECoP					
18	Is the project area water scarce?					
18.1	If answer to No. 18 is yes, are possibilities of use of existing water sources identified in consultation with the villagers, PRI or Govt. Departments? (Community water sources to be used only with their consent)					List of existing perennial sources prepared
18.2	Are provisions in the specifications made for identification, procurement and rehabilitation arrangements to be carried out by the contractor as per ECoP					

Sl. No.	Items for inclusion in DPR	Response				Attachments
		Yes	No	NA	Indicate number	
IX. Water Bodies						
19	Does the alignment cut across or passing adjacent to water body?					
19.1	Are consultation conducted with community for seeking consent and measures to be taken to mitigated impacts					
19.2	Are detailed designs prepared indicating pond to be affected					Detailed blown up drawing indicating the pond
19.3	Are provisions made for control of pollution of pond water during construction					
19.4	Are provisions made for rehabilitation of the water body, if affected					
X. Slope Stability, Soil Erosion & Top soil conservation						
20	Is stability analysis carried out for the breast walls/retaining walls					Information to be included in DPR
21	Are slope stabilization bio-engineering measures included in the DPR					Locations of measures where required along with the measures suggested
22	Are erosion control measures included in the DPR					Locations of measures required and measures suggested
23	Are species of vegetation to be grown over the steep slopes determined					List of species along with the growth & root characteristics, water requirements
24	Are provisions made for conservation of topsoil in stockpiles					
24.1	Are stockpile preservation techniques included in the specifications for the activities of the contractor					
24.2	Is reuse of topsoil by been included in the special conditions of contract					
24.3	Has special provisions such as chutes been made to protect high banks					
XI. Drainage						
25	Does hydrological studies indicate afflux greater than 450mm due to construction of cross drainage structures					Locations, height of afflux and discharge expected
25.1	Are culverts at such locations designed to handle the afflux and to ensure that upstream areas do not get flooded and excessive scour caused on downstream nor fields affected					Reasons for not providing culverts
25.2	Are outfalls identified for discharge from the openings capable of disposing it					
25.3	In case existing outfalls are not adequate, are alternate locations for discharge identified					Information on alternate discharge outfalls to be presented
26	Are provisions for stone lined side drains in high rainfall areas and hill areas made in the DPR					
27	Are provisions for channel drains in case of high embankments (> 1.5m) been made in the DPR					Locations where specified
28	Are contractor's responsibilities as per ECoP-13					

Sl. No.	Items for inclusion in DPR	Response				Attachments
		Yes	No	NA	Indicate number	
	in Pre-construction and construction stages included as part of specifications					
29	Are provisions made in the DPR for erection of safety devises, flood warning signs and warning posts at construction locations over drainage channels					
30	Has provision been made for construction of siphons for irrigation channels and PAPs informed about it					
XII. Forests & Tree Plantation						
31	Are trees being cut by the project, if yes indicate number of trees felled					
31.1	Is clearance from the forest department obtained					
31.2	Is land identified for compensatory plantation					
31.3	Is roadside plantation being taken up? If yes indicate number of trees being planted					
31.4	Are arrangements for supply of saplings from forest department and maintenance by PRI being made?					
32	Is any forest land being diverted for the project					
32.1	If yes to No. 32, is clearance from forest department obtained?					Clearance from Forest Department
32.2	Is land identified for handing over to forest department					Details of land use/area of land identified
32.3	Are provisions made in the specifications to avoid setting up of construction camps/borrow areas and new quarry areas in the forest areas?					
XIII. Natural Habitat						
33	Does any natural habitat as per ECoP 19 exists along the project corridor					
33.1	Is inventORIZATION of ecological features being done during transect walk					
33.2	Are provision for road design made as per ECoP					
33.3	Is Natural habitat Management Plan prepared					Natural Habitat Management Plan
33.3.1	If yes, are all aspect as per ECoP 19, Clause 19.2.7					
XIV. Pollution Prevention measures						
34	Are provisions made for administering pollution control measures at construction sites as per ECoP					
35	Are provisions made for safe disposal of wastes from construction sites					Location of disposal sites and arrangements made for safe disposal
XV. Safety						
36	Are provisions made for worker's health & hygiene at construction camps					Layout of construction camp with arrangements for health & hygiene of workers
37	Are provisions made for traffic diversions during construction					Provide in bid document

Sl. No.	Items for inclusion in DPR	Response				Attachments
		Yes	No	NA	Indicate number	
37.1	Are traffic diversions / closure of traffic been intimated to the public					
38	Are provisions made for signage, demarcating cones and tapes during construction on tracks being utilized by traffic at present					
39	Are provisions made for supply of Personal Protective Equipment to the workers					Reference to the bill of quantities
40	Are provisions made for construction of parapet walls on hill roads for safety of road user					
XVI. Finalization of Alignment						
41	Are designs conforming to IRC standards, if no then are the following criteria adopted. Indicate RoW					
41.1	Design speed considered is not be less than 40 km/hr in plain areas and 35 km/hr in rolling terrain					
41.2	Roadway width of 6m for link routes & 9m in cutting sections in desert areas					Locations where provided
41.3	Carriageway width of 3.75m to be adopted universally.					
41.4	Embankment Height of 0.3 to 0.4 m in arid & sandy areas. Follows natural topography in desert areas					
41.5	Minimum absolute curve radius of 50m @ 40 km/hr and 38 m @ 35 km/hr					
41.6	Junction design in conformance to IRC: SP-20: 2002					
42	Are enhancements mentioned in ECoP provided in the design - mention details against each given below					
42.1	Cattle crossings at their normal crossing routes for safety of cattle and road user					Design & locations
42.2	Cross roads for access to & from agriculture lands to avoid damage to embankment and roadside drain					Design & locations
42.3	Paved shoulders at destination and villages en-route and provide bus bays					
42.4	Widening of embankment where possible to provide a platform for storing maintenance materials					Locations where provided
XVII. Induced Development						
43	Are provisions made for demarcating lands for use of service shops					Location & area
44	Are provisions made for avoiding encroachments onto the available road width					
45	Are provisions made for control of development along the road near locations vulnerable to induced development					
XVIII, Debris Disposal						
46.1	Has site for disposal of construction debris (if any) been identified					Show location on the plans in DPR

Sl. No.	Items for inclusion in DPR	Response				Attachments
		Yes	No	NA	Indicate number	
46.2	Has provision been made to ensure that the debris do not spill over in the valleys and there is no leeching from toxic waste					Show protection measures
XVIII. Monitoring						
47	Are provisions made for supervision of implementation of the environmental measures as per ECoP					
48	Are steps provided for inspection of the bridges and culverts					

ECoP-19.0 Natural Habitats

19.1 General

19.1.1 This code of practice envisages measures to be undertaken during blacktopping / widening of PMGSY Road passing through natural habitats. These measures shall be undertaken in addition to the measures laid down in the other ECoPs.

19.1.2 As per the World Bank OP 4.04, the conservation of natural habitats⁶, like other measures that protect and enhance the environment, is essential for long-term sustainable development. A precautionary approach to natural resource management to ensure opportunities for environmentally sustainable development has been adopted for the project.

Natural Habitats means...

- National Park
- Reserve Forest
- Sanctuaries
- Notified Wetlands
- Fisheries and Aquatic Habitats

Main features of the Bank's Natural Habitats Policy (OP 4.04)

The policy on natural habitats contains two major provisions with respect to biodiversity conservation and EA. Firstly, it prohibits Bank involvement in projects, which involve significant conversion or degradation of critical natural habitats. These include: existing protected areas and adjoining or linked areas or resources (such as water sources) on which the protected areas depend; and sites identified as meriting protection. Secondly, where natural habitats out-side protected areas are within a project's area of influence, the project must not convert them significantly unless:

- There are no feasible alternatives
- The EA demonstrates that benefits substantially outweigh the costs
- Mitigation measures acceptable to the Bank are implemented, which would normally include support for one or more compensatory protected areas that are ecologically similar to, and no smaller than, the natural habitats adversely affected by the project

19.2 Project Planning and Design

19.2.1 To minimize the adverse impact on the ecology of the natural habitats, selection of alignment should be as per ECoP-1.0, "Project Planning & Design".

19.2.2 A detailed inventory of ecological features along the proposed rural road shall be prepared with the help of experts/Forest Department.

19.2.3 The nature and type of impact on natural habitats due to road construction shall be identified. Magnitude of the impact to the extent feasible on the ecological features shall also be assessed.

⁶ Natural habitats are land and water areas where (i) the ecosystems' biological communities are formed largely by native plant and animal species, and (ii) human activity has not essentially modified the areas primary ecological functions.

Ecological Features...	Adverse Impacts...	
	Direct Impacts	Indirect Impacts
<ul style="list-style-type: none"> • Area of affected habitat • Type and number of endangered species of flora and fauna • Stream and water bodies • Breeding ground and seasons • Migration season of bird species • Animal crossing 	<ul style="list-style-type: none"> • Diversion of land • Fragmentation of ecosystem • Cutting of trees • Trampling of vegetation • Contamination of water due to the usage of water from the source within the natural habitat • Loss of breeding grounds • Interruption to animal crossings leading to collision with animals • Interruption of biochemical cycle 	<ul style="list-style-type: none"> • Increased accessibility causing modification of ecosystem • Contamination of biota: Increased humans activity • Motor vehicles introduce the potential for contamination of water, air, and soil. • Fires due to increased human activity. • Transmission of disease which may have impact on the plant and animal life.

19.2.4 Impacts identified on the natural habitats shall be minimized. Minimization shall be through precautionary measures or through appropriate mitigation measures. Following are the measures undertaken along the road passing through natural habitats:

- Constricting the road width to 6.0 m to minimize the extent of diversion of forest land and cutting of trees
- Traffic calming devices shall be introduced where necessary.
- Signage (viz. speed limit, animal crossing, switch of headlight etc) shall be provided as per IRC: 67-2001 Code of Practice for road sign.

19.2.5 In addition to the above measures, specific impacts identified on site shall be mitigated as per the recommendation of the forest department / officer in charge of the identified natural habitat.

19.2.6 In case proposed alignment falls within the catchment of a water body or a stream, a flush causeway shall be constructed without impacting the drainage system. The length of the causeway shall be as per the existing water spread. The causeway shall be strictly in compliance with IRC:SP-20:2002. In no circumstances a water body within the natural habitat shall be cut across or filled for the purpose of laying the road.

19.2.7 A Natural Habitat Management Plan shall be prepared for the stretch passing through the natural habitat covering the following aspects:

- Project Description, describing the project background along with project objective and benefits.
- Policy, legal & Administrative framework: highlighting the institutional setting and legal framework along with the clearance required for the project.
- Baseline environmental / ecological profile highlighting the existing scenario along the PMGSY Road as well as in its influential area.
- Analysis of Alternatives describing design alternatives and analyze them to evaluate best-fit option.
- Identification and Assessment of Impact: adverse impact shall be identified and evaluated in compliance with ECoP's for the best-fit option.
- Management Plan describing the avoidance as well as mitigation measures shall be suggested along with the monitoring and implementation mechanism.
- Budgetary Provision describing the costs associated with the management measures.

19.3 Pre-construction Stage

- 19.3.1 No Construction Camps, Stockyards, Concrete Batching or Hot Mix Plants shall be located within the natural habitat or within 500m from its boundary.
- 19.3.2 Contractor in consultation with forest ranger or any other concerned authority shall prepare a schedule of construction within the natural habitat. Due consideration shall be given to the time of migration, time of crossing, breeding habits and any other special phenomena taking place in the area for the concerned flora or fauna.

19.4 Construction Stage

- 19.4.1 Procurement of any kind of construction material (as quarry or borrow material) from within the natural habitat shall be strictly prohibited
- 19.4.2 No water resources within the natural habitat shall be tapped for road construction.
- 19.4.3 Use of mechanized equipment shall be kept minimum within the natural habitat. Contractor must ensure that there will be no parking of vehicles machine and equipment within the natural habitat.
- 19.4.4 Disposal of construction waste within the natural habitat shall be strictly prohibited and as far as possible reuse shall be undertaken as per Table 10-2 type of waste of ECoP-10.0, "Waste Management".
- 19.4.5 PIU shall nominate one expert to carry out audit at all stages of project in accordance with Checklist A, B and C of ECoP-18.0, "Environmental Audit" to ensure all provision are followed as per ECoPs.

19.5 Post Construction Stage

- 19.5.1 The road passing through the natural habitat shall be declared as a silence zone and provisions as per clause 19.2.4 of this ECoP shall be made.
- 19.5.2 Compensatory tree plantation within the available Right of Way shall be done.
- 19.5.3 The PIU must ensure maintenance of drainage structure as per ECoP-12.0, "Drainage".

ECoP-20.0 Consultations for Environmental Aspects

20.1 General

- 20.1.1 All stages of project planning, preparation and implementation will involve interaction with the community. Consultations with community or other stakeholders are an integral part of the project activities. These would in general be conducted by the PIU in prioritization and project preparation and post-construction stages. This ECoP is intended to provide guidelines for the PIU/Contractor for conducting the consultations.

Consultations to be conducted ...

- Information dissemination about proposed PMGSY roads under core network
- During Project Preparation for ...
- Dissemination of project information
 - For finalizing alignment
 - For disseminating information on incorporation/non-incorporation of environmental concerns into project design
- During Implementation for...
- Seeking consent on temporary use of land for setting up construction facilities, borrowing, traffic diversions and disposal of wastes
 - Seeking consent on extraction of water for construction, relocation of common property resources and cultural properties
 - Encouraging tree plantation and
 - Avoiding / minimizing induced development

20.2 Project Preparation Stage

- 20.2.1 The proposed PMGSY roads under core network shall be displayed at Zilla Parishad headquarters. Thereafter, each road shall be taken up for preparation of DPR as per the priority formula adopted by the State Government.
- 20.2.2 During the DPR stage, information on the connectivity and other provisions of ESMF shall be disseminated at the village Panchayat of the concerned habitation in the form of Brochure as presented in Annexure 20-1. It shall indicate the need for adequate land width and voluntary land donation.
- 20.2.3 To enable incorporation of environmental and social concerns into the project preparation, an inventory of environmental and social features of the road needs to be prepared. This is done through a Transect Walk. The transect walk shall be a participatory process organized by the PIU in co-ordination with the Gram Panchayat and the revenue officials at the village level. In case, the proposed alignment is likely to pass through a natural habitat (as per ECoP-19.0, "Natural Habitats") then an official from Forest Department would also be accompanying the team. Details of the conduct of transect walk are as per Annexure 20-2.
- 20.2.4 Within one week of conduct of transect walk, the output of transect shall be disseminated by the PIU indicating how the concerns of community have been incorporated. If due to technical or other reasons, the choices of the community are not incorporated, the reasons for not accepting any suggestion shall be communicated and subsequently alignment shall be finalized. Format for recording the consultation outputs is presented as Annexure 20-3.

20.3 Pre-Construction Stage

- 20.3.1 Consultations during this stage will be towards seeking consent of landowners for clearance of the Road land width, temporary use of land and material provision for construction.
- 20.3.2 The consultations to be conducted during this stage and aspects to be covered are presented in the individual ECoP prepared for each aspect.

20.3.3 PIU will be conducting the consultations towards clearance of the proposed road land width, while Contractor will be conducting consultations for temporary use of land and for material provision for construction. Table 20-1 summarizes the consultations to be conducted and provisions made in the individual ECoPs along with the responsibilities.

Table 20-1: Consultations during Pre-Construction Stage

Sl.No.	Aspects of Consultation	Desired Outputs	Reference
1	Consultations for Clearance of Road land width		
1.1	Consultation for Relocation of Common Property Resources (CPR)	<ul style="list-style-type: none"> Consent for relocation of CPR Identify area for relocation 	ECoP-2.0
1.2	Relocation of Cultural Properties	<ul style="list-style-type: none"> Consent for relocation of cultural property Discussion on design for relocated structures Identify area for relocation 	ECoP-15.0
2	Consultations for Temporary use of Land		
2.1	Setting up Construction Camp	<ul style="list-style-type: none"> Consent for setting up the camp Terms of use as: free of cost, payment of rent for use or any other Rehabilitation options for the land subsequent to its use 	ECoP-3.0
2.2	Land for Borrowing	<ul style="list-style-type: none"> Consent for use of land for borrowing Location for storage of Topsoil Rehabilitation options for the land subsequent to borrowing 	ECoP-5.0
2.3	Disposal of Wastes	<ul style="list-style-type: none"> Consent for use of land for waste disposal Type of wastes to be disposed Rehabilitation of land subsequent to waste disposal 	ECoP-10.0
2.4	Diversion of Traffic	<ul style="list-style-type: none"> Consent for use of land for temporary traffic diversion Site preparation as removal of topsoil along the route for temporary diversion Rehabilitation of land subsequent to completion of construction in the stretch 	ECoP-14.0
3	Consultations for material extraction		
3.1	Extraction of water	<ul style="list-style-type: none"> Seeking consent on extraction of water Terms of use as: free of cost or payment for water used 	ECoP-8.0
3.2	Borrowing of earth	<ul style="list-style-type: none"> Seeking consent for borrowing Terms of use as: free of cost or payment for earth, depth of borrowing 	ECoP-5.0

20.4 Construction Stage

20.4.1 The Site Engineer in charge of the road shall settle any grievances raised by the community during this stage. If grievances remain unaddressed, they shall be referred to the concerned senior officers of PIU (Assistant Engineer and Executive Engineer) and shall be addressed as per the Grievance Redressal Mechanism devised in the Resettlement Framework.

20.4.2 The PIU shall consult the community and PRI in identifying people volunteering for Tree plantation. All aspects of tree plantation and maintenance shall be briefed to them towards the end of construction period as per the ECoP-16.0, "Tree Plantation".

20.5 Post-Construction Stage

20.5.1 The PIU shall conduct consultation with the PRI and community on induced development aspects along the roads constructed. Awareness on impacts likely due to induced development will be generated during the consultations. Measures to be undertaken for its control and avoid encroachments shall be discussed and necessary arrangements shall be notified as per the ECoP-17.0, “Induced Development”.

20.6 Consultation Schedule

20.6.1 Consultations to be conducted at various stages of the project and agencies responsible shall be as per the schedule given in Table 20-2 below.

Table 20-2: Schedule of Consultations

Sl.No	Activity	Main Responsible Agency	Other Agency / Department Involved	Consultation Tool	Stakeholders	Pre-selection	DPR Preparation												Post Construction
							1	2	3	4	5	6	7	8	9	10	11	12	
1	Prioritization																		
1.1	PMGSY road under Core Network	PIU		Dissemination	Pubic														
2	Project Preparation																		
2.1	Project Information & ESMF	PIU		Dissemination	Village Community														
2.2	Finalization of Alignment	PIU	PRI, RD & FD	Transect Walk	Village Community														
2.3	Follow up	PIU		Consultation	Village Community														
3	Pre-Construction Stage																		
3.1	Clearance of Road land width																		
3.1.1	Relocation of Common Property Resource	PIU		Consultation	Village Community														
3.1.2	Relocation of Culture Property	PIU		Consultation	Village Community														
3.2	Temporary Usage of Land																		
3.2.1	Setting up of Construction Camp	Contractor		Consultation	Property Owner / PRI														
3.2.2	Diversion of Traffic	Contractor		Consultation	Property Owner / PRI														
3.2.3	Disposal of Wastes	Contractor		Consultation	Property Owner / PRI														
3.3	Material Extraction																		
3.3.1	Borrowing of Earth	Contractor		Consultation	Property Owner / PRI														
3.3.2	Extraction of Water	Contractor		Consultation	Property Owner / PRI														
4	Construction Stage																		
4.1	Redressal of Grievances	Contractor	PIU	Consultation	Property Owner / Community														
5	Post Construction Stage																		
5.1	Identification for Voluntary Tree Plantation	PIU	PRI	Consultation	Village Community														
5.2	Induce Development Aspect	PIU	PRI	Consultation	Village Community														